

# ICT ENABLED TOOLS FOR EFFECTIVE TEACHING-LEARNING PROCESS



*G. Kalvikkarasi*

**Dr.G. KALVIKKARASI**  
PRINCIPAL  
DHARMAMURTHI RAO BAHADUR  
CALAVALA CUNNAN CHETTY'S HINDU COLLEGE  
PATTABIRAM, CHENNAI-600072.



GPS Map Camera



### Pattabiram, Tamil Nadu, India

CUNNAN RUBY JUBILEE BLOCK, FOOD CORPORATION OF INDIA-PATTABIRAM, Deena Dayalan Nagar, Pattabiram, Tamil Nadu 600054, India

Lat 13.121726°

Long 80.073087°

23/09/22 12:12 PM GMT +05:30



*G. Kalvikkarasi*

**Dr.G. KALVIKKARASI**  
PRINCIPAL  
DHARMAMURTHI RAO BHADUR  
CALAVALA CUNNAN CHETTY'S HINDU COLLEGE  
PATTABIRAM, CHENNAI-600072.

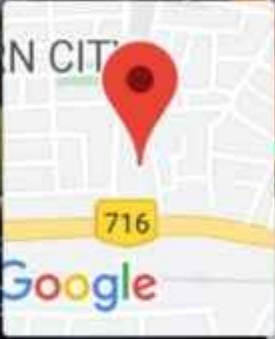
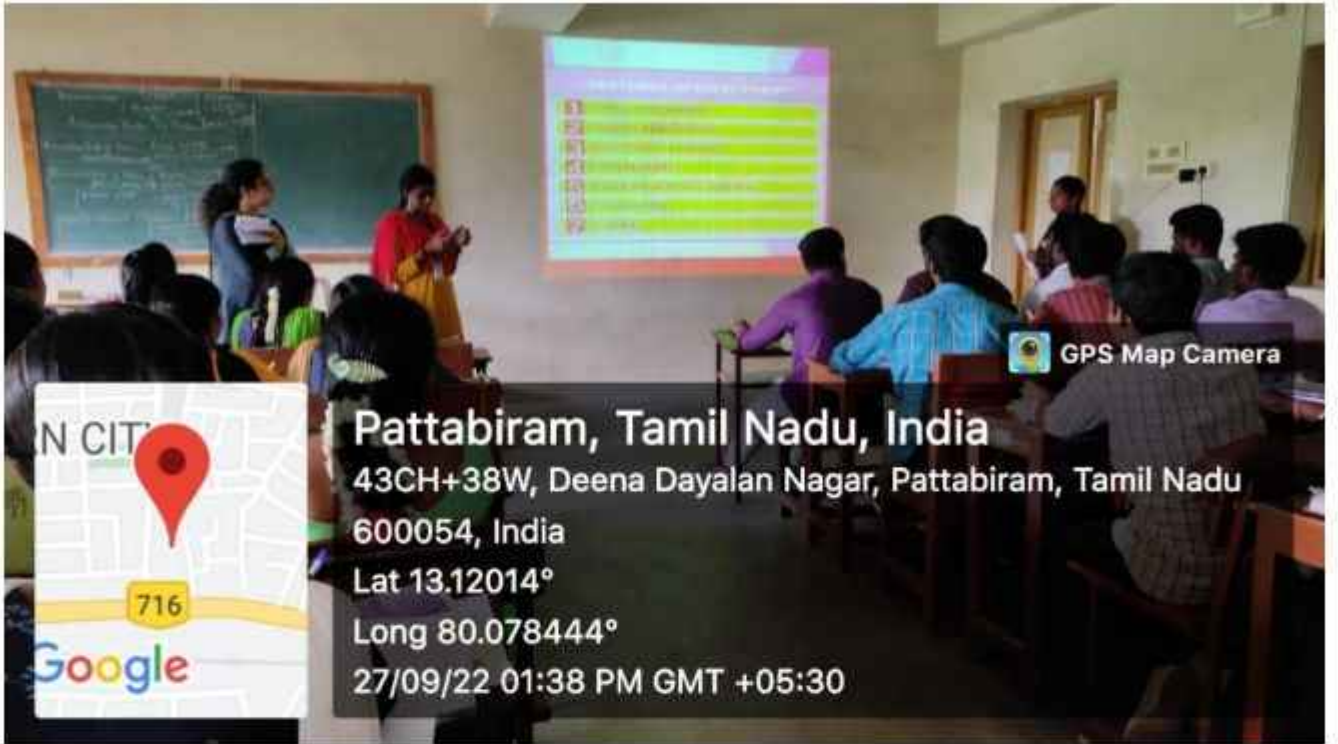

**Pattabiram, Tamil Nadu, India**

43CH+38W, Deena Dayalan Nagar, Pattabiram, Tamil Nadu  
600054, India

Lat 13.12014°

Long 80.078444°

27/09/22 01:38 PM GMT +05:30

GPS Map Camera



**Pattabiram, Tamil Nadu, India**

7, Anna Nagar Main Rd, Modern City, Deena Dayalan Nagar,  
Pattabiram, Tamil Nadu 600072, India

Lat 13.119113°

Long 80.078112°

24/09/22 01:26 PM GMT +05:30

GPS Map Camera



*G. Kalvikkarasi*

**Dr. G. KALVIKKARASI**

PRINCIPAL

DHARMAMURTHI RAO BAHADUR  
CALAVALA CUNNAN CHETTY'S HINDU COLLEGE  
PATTABIRAM, CHENNAI-600072.



*G. Kalvikkarasi*

**Dr.G. KALVIKKARASI**

PRINCIPAL

DHARMAMURTHI RAO BAHADUR

CALAVALA CUNNAN CHETTY'S HINDU COLLEGE

PATTABIRAM, CHENNAI-600072.



GPS Map Camera



### Pattabiram, Tamil Nadu, India

SCIENCE BLOCK, FOOD CORPORATION OF INDIA-PATTABIRAM,

Deena Dayalan Nagar, Pattabiram, Tamil Nadu 600054, India

Lat 13.121785°

Long 80.074308°

16/03/23 11:43 AM GMT +05:30



*G. Kalvikkarasi*

**Dr. G. KALVIKKARASI**

PRINCIPAL

DHARMAMURTHI RAO BAHADUR  
CALAVALA CUNNAN CHETTY'S HINDU COLLEGE  
PATTABIRAM, CHENNAI-600072.



GPS Map Camera

**Pattabiram, Tamil Nadu, India**

DHAMAMURTHY RAO BAHADUR CUNNAN CHETTY BLOCK, FOOD CORPORATION OF INDIA-PATTABIRAM, Deena Dayalan Nagar, Pattabiram, Tamil Nadu 600054, India

Lat 13.121417°

Long 80.0741°

28/03/23 02:36 PM GMT +05:30



Google



GPS Map Camera

**Pattabiram, Tamil Nadu, India**

CUNNAN RUBY JUBILEE BLOCK, FOOD CORPORATION OF INDIA-PATTABIRAM, Deena Dayalan Nagar, Pattabiram, Tamil Nadu 600054, India

Lat 13.12162°

Long 80.073356°

14/07/23 03:34 PM GMT +05:30



Google



*G. Kalvikkarasi*

**Dr.G. KALVIKKARASI**

PRINCIPAL

DHARMAMURTHI RAO BAHADUR  
CALAVALA CUNNAN CHETTY'S HINDU COLLEGE  
PATTABIRAM, CHENNAI-600072.



GPS Map Camera

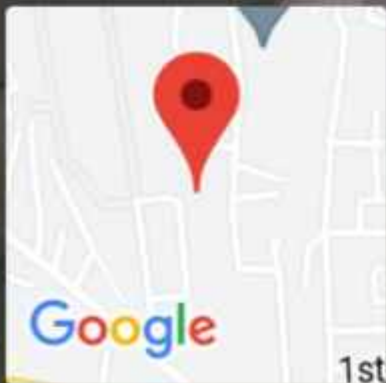

## Pattabiram, Tamil Nadu, India

CUNNAN RUBY JUBILEE BLOCK, FOOD CORPORATION OF INDIA-PATTABIRAM, Deena Dayalan Nagar, Pattabiram, Tamil Nadu 600054, India

Lat 13.121807°

Long 80.073153°

06/09/22 05:23 PM

Measurement  
Return  
ER

CHARACTERISTICS OF  
DERIVATIVE MARKET  
INSTRUMENTS  
DITYA KUMAR SINGH

GPS Map Camera

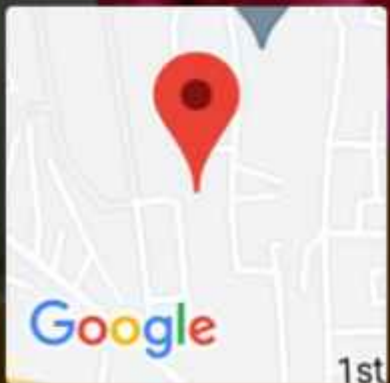

### Pattabiram, Tamil Nadu, India

CUNNAN RUBY JUBILEE BLOCK, FOOD CORPORATION OF  
INDIA-PATTABIRAM, Deena Dayalan Nagar, Pattabiram, Tamil Nadu 600054,  
India

Lat 13.12182°

Long 80.073169°

06/09/22 05:26 PM

III B.A English

CCB-12

 GPS Map Camera

## BRaille

CUNNAN AUDITORIUM Hindu College, Pattabiram, Tamil

Nadu 600054, India

Lat 13.121588°

Long 80.073317°

01/03/23 03:12 PM GMT +05:30

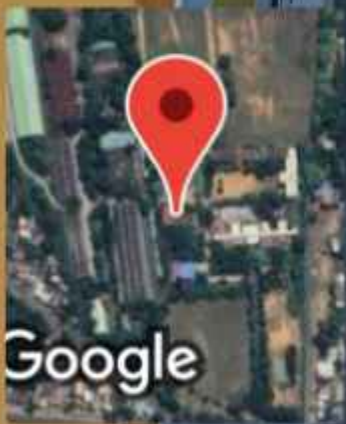



 GPS Map Camera

## **BRILLE**

**CUNNAN AUDITORIUM Hindu College, Pattabiram, Tamil**

**Nadu 600054, India**

**Lat 13.121588°**

**Long 80.073317°**

**01/03/23 03:14 PM GMT +05:30**

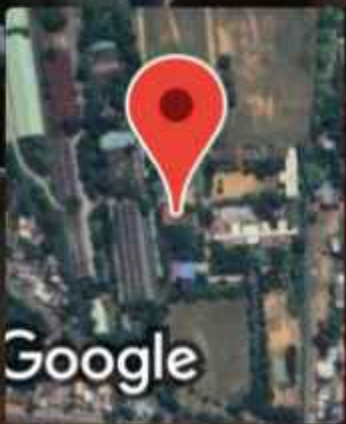



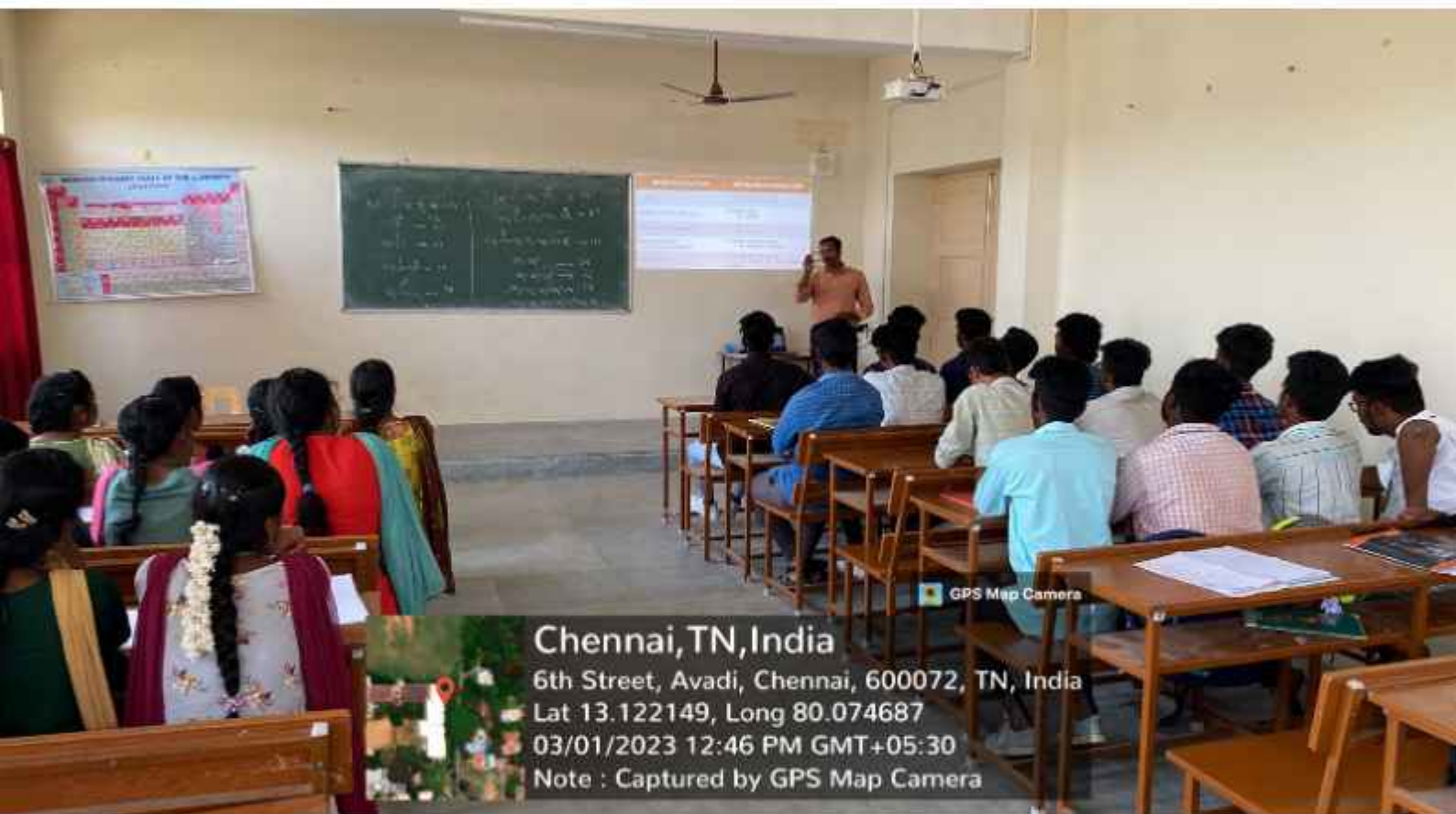

Chennai, TN, India

6th Street, Avadi, Chennai, 600072, TN, India

Lat 13.122149, Long 80.074687

03/01/2023 12:46 PM GMT+05:30

Note : Captured by GPS Map Camera



 GPS Map Camera

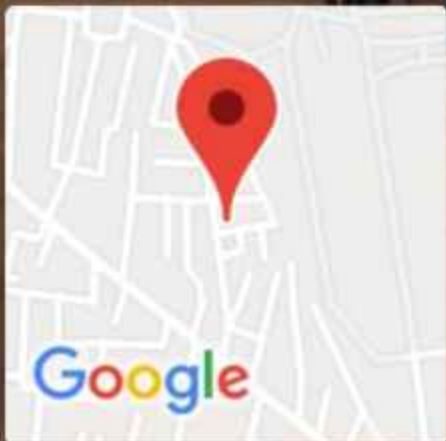

**Pattabiram, Tamil Nadu, India**

9, Vinayagar kovil St, Deena Dayalan Nagar,  
Pattabiram, Tamil Nadu 600072, India

Lat 13.123088°

Long 80.07043°

26/10/21 03:52 PM

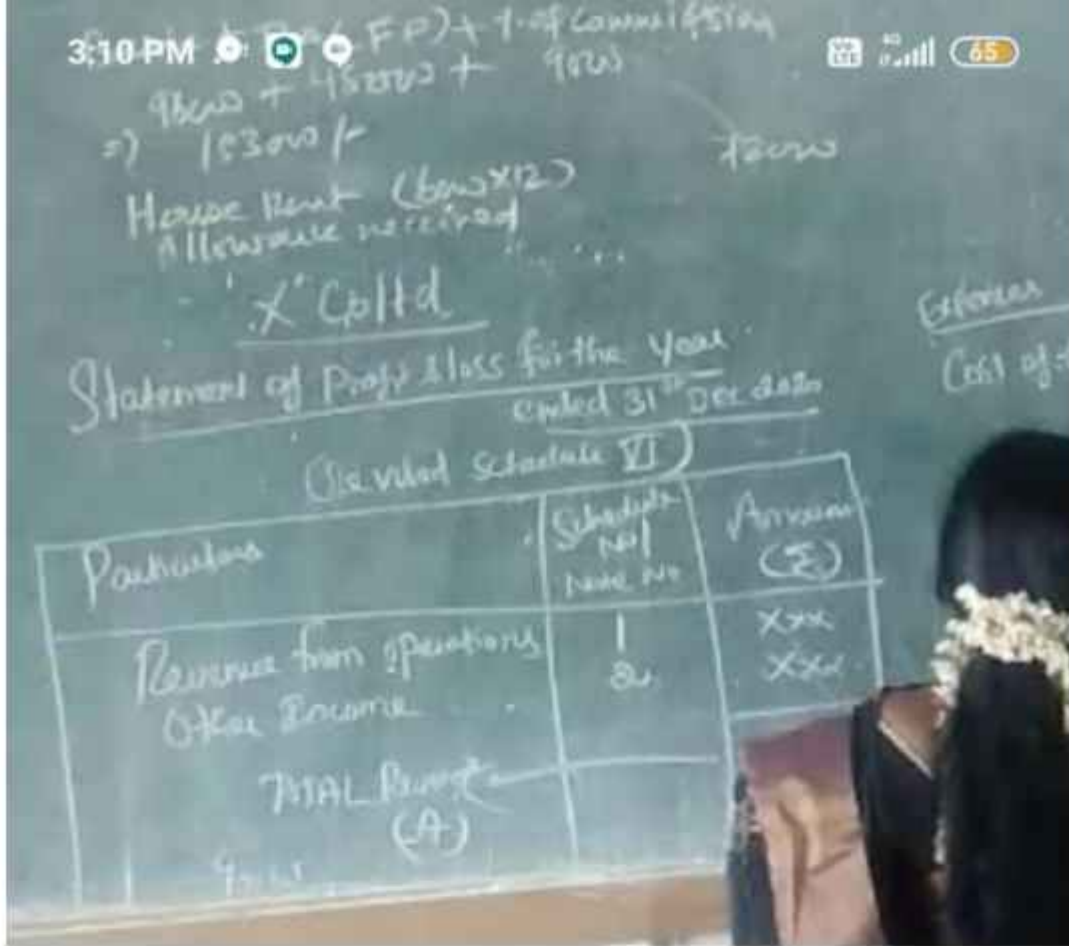

(69)



20AF141 Dharshini. E (You)



20AF209 Karthikeyan S



Dr EJ



20Af216 Raghul Ram



Others in the meeting (65)



1) Credit cards  
 2) Auto loans  
 3) Insurance

Choose and offer a wide  
 of services.  
 - The participating banks

Journal Entries  
 \* In the Books of X Ltd

30<sup>th</sup> Nov & 31<sup>st</sup> Dec

100,000 X 3% = 3,000

10% Debentures Acc Dr 1,00,000  
 To Bank Acc 1,00,000

10% Debentures Acc Dr 10,000  
 To Profit on Cancellation of 10% Debentures Acc 10,000

Dr EJ

You

Mounica

Prasanna

65 others





**Pattabiram, Tamil Nadu, India**

CUNNAN RUBY JUBILEE BLOCK, FOOD CORPORATION OF INDIA-PATTABIRAM, Deena Dayalan Nagar, Pattabiram, Tamil Nadu 600054, India

Lat 13.122218°  
Long 80.072984°  
28/04/22 11:13 AM

GPS Map Camera

### 3.EQUITY MUTUAL FUNDS:

*Equity mutual funds invest the pooled money majority in stock of different companies*

*Hence equity mutual funds have an inherent higher market risk.*

*Factors like earnings, revenue forecast, management changes and company economic policy impact price movements and returns.*

*Returns from the equity funds have high fluctuation*



GPS Map Camera

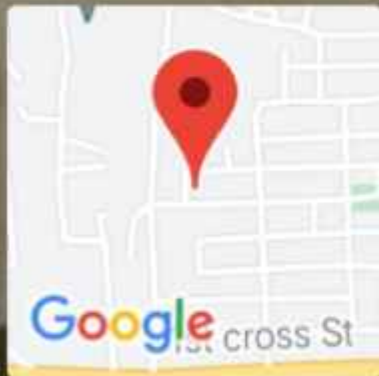

**Pattabiram, Tamil Nadu, India**

81, 5th Cross St, Modern City, Deena Dayalan Nagar,

Pattabiram, Tamil Nadu 600054, India

Lat 13.121499°

Long 80.075319°

26/08/22 12:54 PM



# SWAPS & IT'S TYPES

15/09/2022 12:48

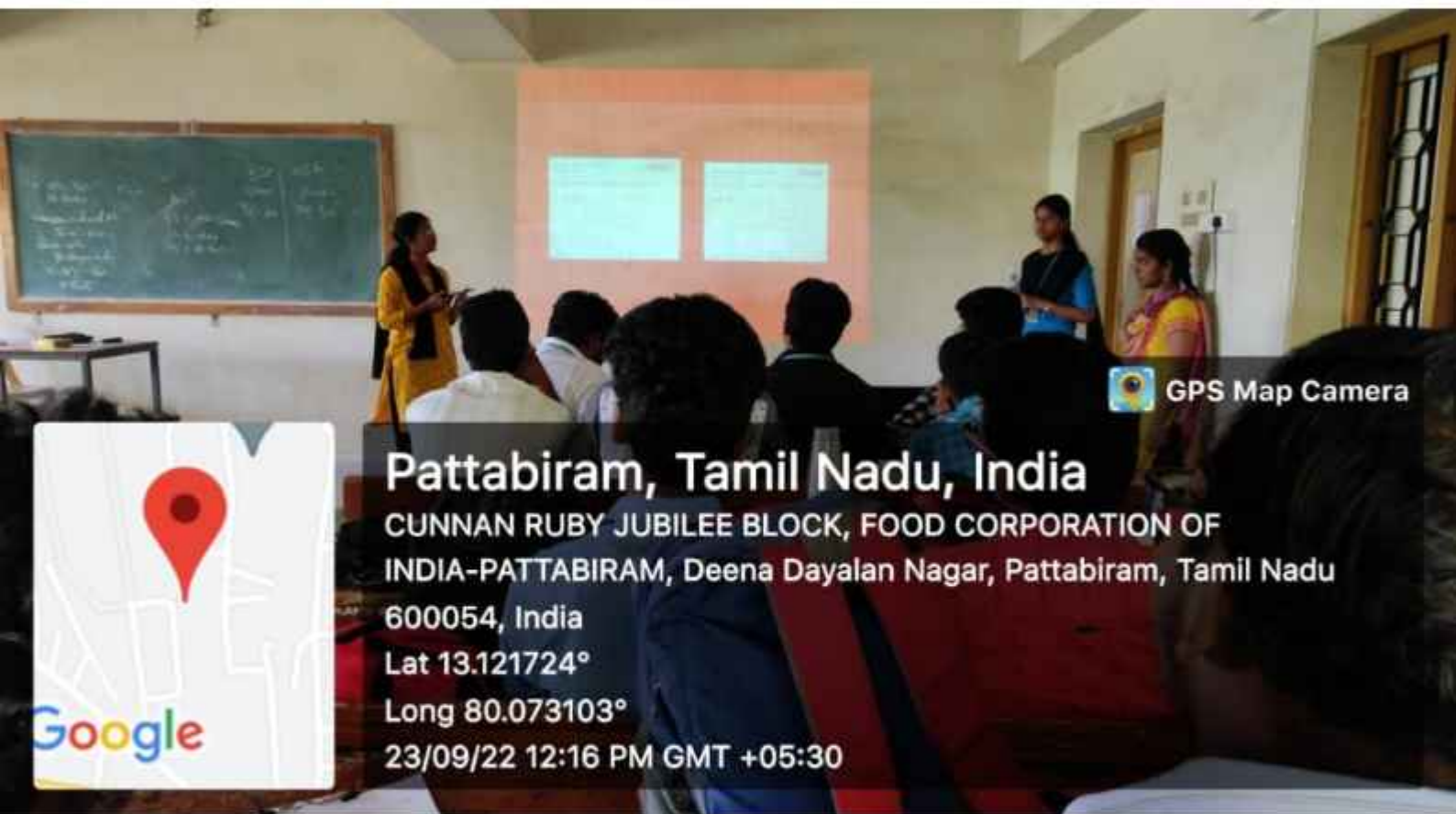

 GPS Map Camera

## Pattabiram, Tamil Nadu, India

CUNNAN RUBY JUBILEE BLOCK, FOOD CORPORATION OF  
INDIA-PATTABIRAM, Deena Dayalan Nagar, Pattabiram, Tamil Nadu

600054, India

Lat 13.121724°

Long 80.073103°

23/09/22 12:16 PM GMT +05:30

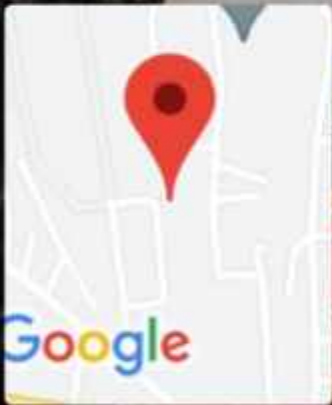

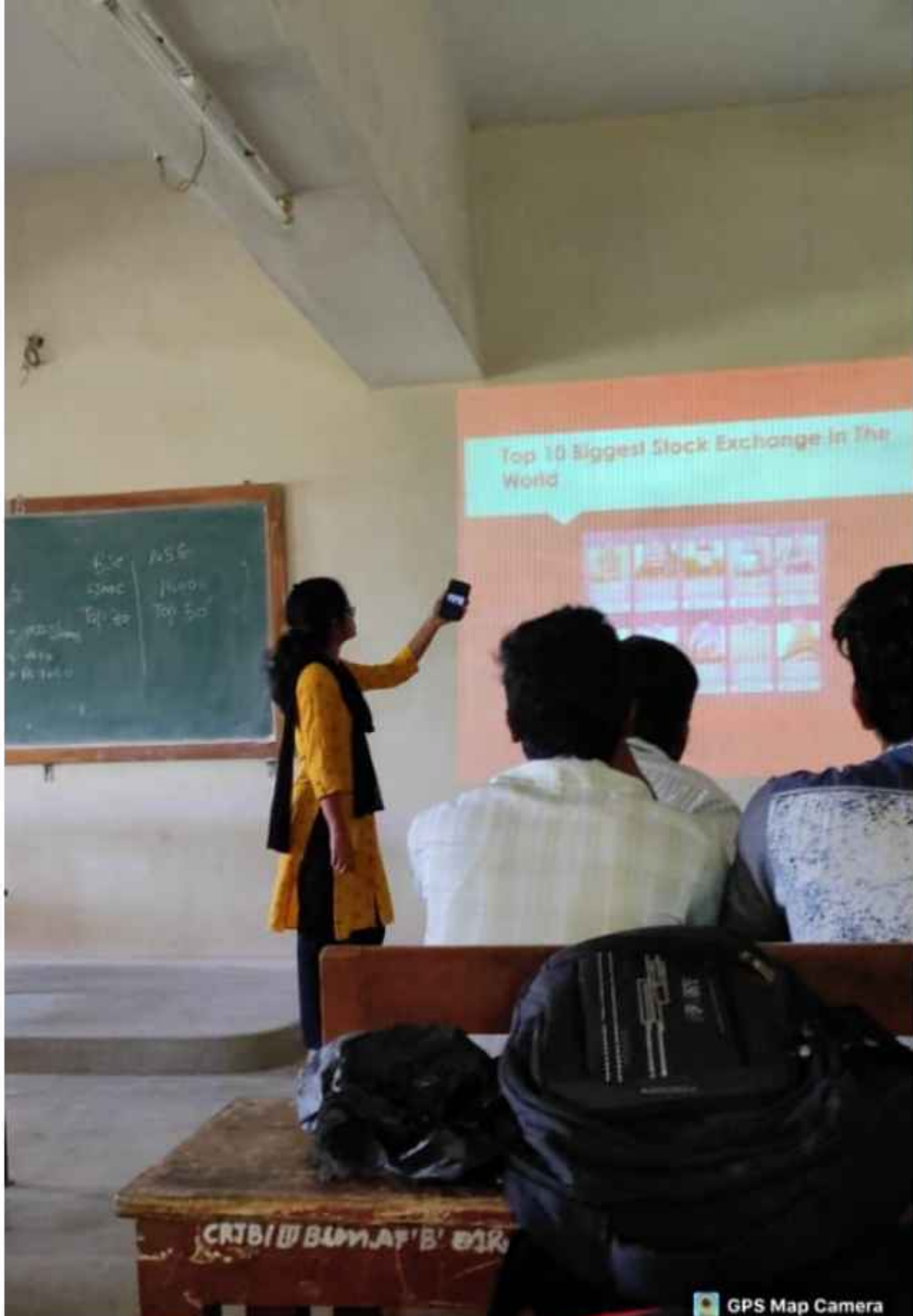

### Top 10 Biggest Stock Exchange In The World



Handwritten notes on a chalkboard, including 'NSE', 'NYSE', 'Top 10', and 'Top 50'.

GPS Map Camera

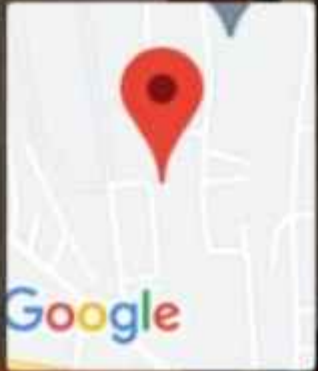

## Pattabiram, Tamil Nadu, India

CUNNAN RUBY JUBILEE BLOCK, FOOD CORPORATION OF INDIA-PATTABIRAM, Deena Dayalan Nagar, Pattabiram, Tamil Nadu 600054, India

Lat 13.121726°

Long 80.073087°

23/09/22 12:12 PM GMT +05:30



GPS Map Camera

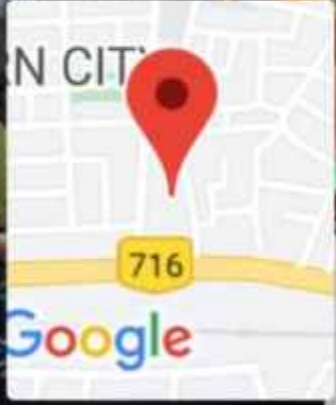

**Pattabiram, Tamil Nadu, India**  
43CH+38W, Deena Dayalan Nagar, Pattabiram, Tamil Nadu  
600054, India  
Lat 13.12014°  
Long 80.078444°  
27/09/22 01:38 PM GMT +05:30



 GPS Map Camera

## Pattabiram, Tamil Nadu, India

7, Anna Nagar Main Rd, Modern City, Deena Dayalan Nagar,  
Pattabiram, Tamil Nadu 600072, India

Lat 13.119113°

Long 80.078112°

24/09/22 01:26 PM GMT +05:30

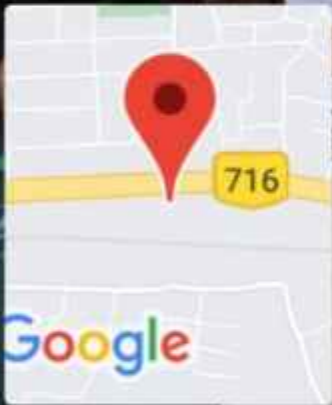



 GPS Map Camera

**Pattabiram, Tamil Nadu, India**

439C+MW5, NH 716, Pattabiram, Tamil Nadu

600072, India

Lat 13.11924°

Long 80.072176°

02/03/23 03:25 PM GMT +05:30





 GPS Map Camera



## Pattabiram, Tamil Nadu, India

7, Thiruvalluvar nagar, Indian Air Force Rd, Deena

Dayalan Nagar, Pattabiram, Tamil Nadu 600072, India

Lat 13.120682°

Long 80.071808°

02/03/23 03:25 PM GMT +05:30



Conclusion:  
To establish a complete and healthy system  
for the common good of society  
we need to eliminate  
**CORRUPTION**

 **GPS Map Camera**

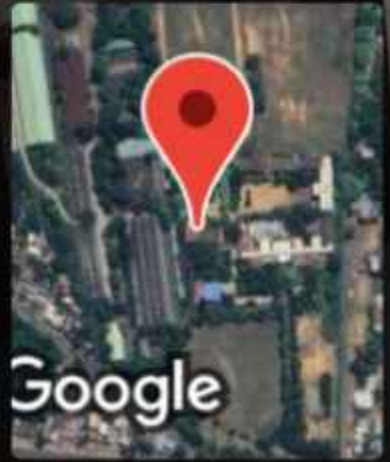

## **Pattabiram, Tamil Nadu, India**

**CUNNAN RUBY JUBILEE BLOCK, FOOD CORPORATION  
OF INDIA-PATTABIRAM, Deena Dayalan Nagar, Pattabiram,  
Tamil Nadu 600054, India**

**Lat 13.1216°**

**Long 80.073302°**

**02/03/23 03:25 PM GMT +05:30**



 **GPS Map Camera**

## **Pattabiram, Tamil Nadu, India**

Indian Air Force Road, 40, Indian Air Force Rd, Deena Dayalan Nagar, Pattabiram, Tamil Nadu 600072, India

Lat 13.121322°

Long 80.070779°

02/03/23 03:25 PM GMT +05:30





GPS Map Camera

## Pattabiram, Tamil Nadu, India

CUNNAN RUBY JUBILEE BLOCK, FOOD CORPORATION OF INDIA-PATTABIRAM, Deena Dayalan Nagar, Pattabiram, Tamil Nadu 600054, India

Lat 13.121602°

Long 80.073301°

02/03/23 03:24 PM GMT +05:30





 **GPS Map Camera**



**Pattabiram, Tamil Nadu, India**  
CUNNAN RUBY JUBILEE BLOCK, FOOD CORPORATION OF INDIA-PATTABIRAM, Deena Dayalan Nagar, Pattabiram, Tamil Nadu 600054, India  
Lat 13.121602°  
Long 80.073303°  
02/03/23 03:24 PM GMT +05:30

(2.3.2)

## Details of ICT tools

### E library



The department has uploaded 170 Ebooks as digital library in the department computer which students have been using for reference and exams. E Books on Indian History, World History and Tamil Nadu history have been classified and arranged

### Kahoot quiz competition and E quiz



kahoot quiz was arranged by the department as a inter department quiz competition in which nearly hundred students participated. Indian history and general knowledge were used for framing questions



*G. Kalinayagi*  
PRINCIPAL,  
DHARMAMURTHI RAO BHADUR CALAVALA CUNNAM  
CHETTIY'S HINDU COLLEGE  
DHARMAMURTHI NAGAR, PATTABIRAM,  
CHENNAI - 600 072.

## Power point presentations

The staff of the department has been using Power point presentations for the benefit of students, for better understanding and for visual presentation.



*C. Srinivasan*  
PRINCIPAL,  
DHARMAMURTHI RAO BAHADUR DALAVALA CUNNAN  
CHETTY'S HINDU COLLEGE  
DHARMAMURTHI NAGAR, PATTABIRAM,  
CHENNAI - 600 072.



Stream

Classwork

People

Grades

Customize

## B.Com 23-26



Announce something to your class



K. Devadharshini

Jul 24, 2023



Authority and Responsibility

By K. Devadharshini

M. Nisha

S. Sugitha

R. Divya



Authority and Responsi...



Add class comment...



Bharathkumar Srinivasan

Jul 19, 2023



Planning Unit Fully

By Bharathkumar



Manoj Kumar  
David Jonathan  
Akash Kumar

 PLANNING.pdf



Add class comment...



Jivana Y jeevana  
Jul 19, 2023



Y Jansi  
Network Technologies

 Network Technologies



Add class comment...



S.Vasantha Kumaran  
Jul 19, 2023



My name is S .Vasantha Kumaran this is my assignment

 Drive file



Add class comment...



Gokul M  
Jul 19, 2023



Gokul.M





Add class comment...



Surendar D  
Jul 19, 2023

Surendar.D



Staffing\_202363\_13510....



Add class comment...



Rogan  
Jul 19, 2023

Rogan



Staffing\_202363\_13510....



Add class comment...



Lakshaya  
Jul 19, 2023

**Directing by N. Lakshaya**



Directing\_202361\_2012...



Add class comment...





Karthi keya  
Jul 19, 2023

Span of management  
By: S.Karthikeya

 Span of management\_2...



Add class comment...



Sayd Ameer  
Jul 19, 2023

Narrow and wide span  
Name sayyed ameer

 Span of management\_2...



Add class comment...



Jaya Varshini  
Jul 19, 2023

N.Jayavarshini

 Directing\_202361\_2012...



Add class comment...



Naveen Kumar  
Jul 19, 2023





Add class comment...



Surendar D  
Jul 19, 2023



Surendar.D



Staffing\_202363\_13510....



Add class comment...



Rogan  
Jul 19, 2023



Rogan



Staffing\_202363\_13510....



Add class comment...



Lakshaya  
Jul 19, 2023



**Directing by N. Lakshaya**



Directing\_202361\_2012...



Add class comment...



K. Akash kumar

 PLANNING\_202362\_204...



Add class comment...



Santhosh Zap  
Jul 19, 2023

Span of Management  
By K.Santhosh

 Span of management\_2...



Add class comment...



B. Santhosh Kumar  
Jul 19, 2023

Types of Organisation Structure  
By b. Santhosh Kumar



Add class comment...



p.mohana priya  
Jul 19, 2023

mohana priya

 Organigram.mom





Add class comment...



Udayakumar Jayaraman  
Jul 19, 2023



Management by exceptions  
By Vaishalee



Add class comment...



Amareswar J  
Jul 19, 2023



Types of Organisation Structure  
By Amar



Add class comment...

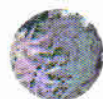

Remona  
Jul 19, 2023



Management by exceptions  
By Remona



Add class comment...



Madhu Madhu  
Jul 19, 2023



R Hemalatha  
R Hemalatha





Janani  
Jul 19, 2023



Janani

Selection



Add class comment...



Vinodha  
Jul 19, 2023



A.Vinodha

Mind Map\_202362\_2136...

Mind Map\_202362\_2131...



Add class comment...



Elakkiya  
Jul 19, 2023



A.Elakkiya

Recruitment



Add class comment...



*G. Kalimuthu*  
PRINCIPAL,  
DHARMAMURTHI RAO RAJADUR, CALAVALA CUNNAM,  
CHETTI & HINDI COLLEGE  
DHARMAMURTHI RAO, PATTABIRAM,  
CHENNAI - 600 072.





*C. Lakshminarayanan*

PRINCIPAL,  
CHASMAMURTHI RAO BANAMURUGAVALLA CUNJIAN  
CHETTIYER HINDU COLLEGE  
DHARMALINGESWARAR, PATTAPOURAM,  
CHENNAI - 600 072.



ICT - விளக்கக் காட்சியுடன் வகுப்பு நடைபெறுதல் - நாள் 21-09-2023

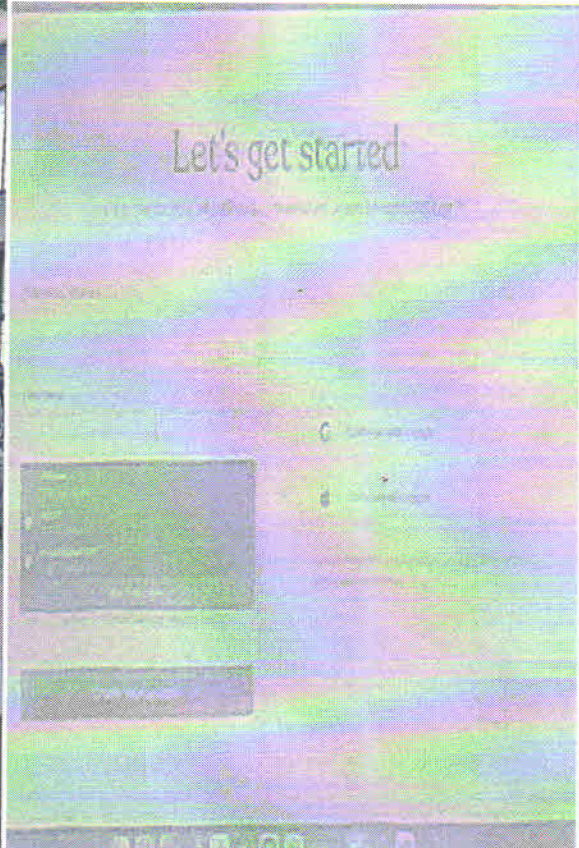



## Chats



Gop



All

Unread

Groups



## CHATS

**G Gopika**

Ok mam

4/29/2024

## CONTACTS

**Gopi**

நில்லா உலகம் நிரம்பா வா...

**Gopi**

Busy

**Saranyagopal**

Never ever give up....

## GROUPS IN COMMON



பன்னாட்டுக் கருத்... 08:45

Saranyagopal is also in this gro...



2 நிமிட பேச்சுப் ... 2/15/2024

G Gopika is also in this group



கணித் தமிழ்ப் பேரவை

G Gopika is also in this group



Your personal messages are end-to-end encrypted

See more chat history on  
the app

Get WhatsApp for Windows



G Gopi...



Syncing older messages. Click to see progress.

4/25/2024

தேம்பாவணி.pdf

8 pages • PDF • 112 kB



12:16 ✓

உடும்பு பேசிய படலம்.pdf

5 pages • PDF • 178 kB



13:05 ✓

Ok mam 13:15

4/29/2024

Document (7) (14).pdf

8 pages • PDF • 122 kB



11:41 ✓

Document (7) (15).pdf

10 pages • PDF • 81 kB



11:44 ✓

Ok mam 14:14



Type a message



109

## Chats



sha



All

Unread

Groups



resterday  
 ✓ Online Tamil tutor



Shame

Thursday

Ok akka



Shamala BA E... 4/29/2024

Reacted to: "Docum..."



Dhakshan Kat... 4/27/2024

0:01



Shasun confer... 4/26/2024

+91 97875 49308: \* பிரே...



Usha

4/24/2024



Nisha Hc

3/11/2024

✓ Photo



Akshaya B.com 2/19/2024

You reacted to: "Co..."



Atshaya

2/14/2024

Atshaya uses a defa...



shakthi Hc

1/1/2024

+91 6379 759 106 changed...

## CONTACTS



Abilasha Radio



See more chat history

on the app

Get WhatsApp for Windows



Shamala B...



4/25/2024

தேம்பாவணை.pdf

8 pages • PDF • 112 kB



12:16 ✓✓

உடும்பு பேசிய படலம்.pdf

5 pages • PDF • 178 kB



13:05 ✓✓

Nandri Amma

16:10

4/29/2024

1) சிலப்பதிகாரம்

2) சூளாமணி

3) மீனாட்சியம்மை பிள்ளைத்தமிழ் 10:59

Amma ithuku notes anupunga ma 11:00

Document (7) (14).pdf

8 pages • PDF • 122 kB



11:41 ✓✓

நன்றி அம்மா

11:42

Document (7) (15).pdf

10 pages • PDF • 81 kB



11:44 ✓✓



Type a message





# Chats



← Non ×



All Unread



Groups

## CHATS



No... 4/3/2024  
+91 76393 2...



NON TAM...



Non Tamil

## MESSAGES

Suja Id Friday  
✓ Model-2010 registr...

Vijayakumar... Thursday  
Model-2010 registratio...

Your personal messages are end-to-end encrypted

See more chat history on the app  
Get WhatsApp for Windows



NonTamil 2023-24  
Dr., French, Roshini, +91 6374 ...



+91 99403 67132 3/26/2024

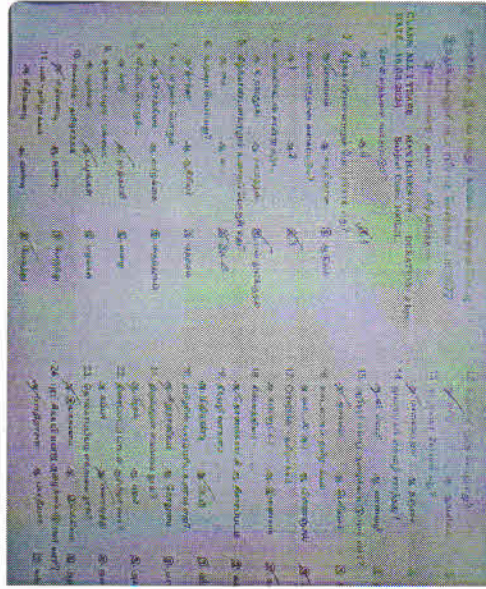

13:52

+91 99403 67132

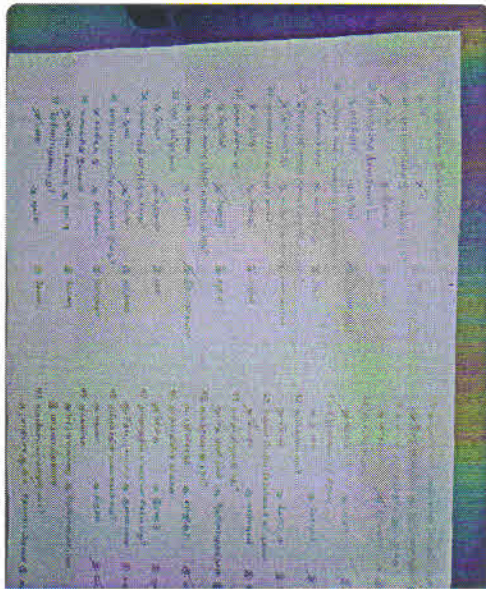

13:53

4/3/2024



+91 76393 21580  
where is the class mam 13:07



Dr. Lakshmi  
Ill economics class room 13:09



Type a message





Chats

பேச்சுப் போட்டி  
Dillybabu, Dr., Lakshmi, Le...

← பேச்சுப்போ X



All Unread



Groups

## MESSAGES

"யாதும் ஊ... 3/23/2024  
+91 85089 06053: உ ...Dr. Lakshmi 3/13/2024  
போட்டி நடத்துபவர்: ...பேச்சுப் போ... 1/3/2024  
Dr.: தமிழ்த் துறை நடத்...[Click here to get older messages from your phone.](#)

1/3/2024



Dr. Lakshmi

**தமிழ்த் துறை நடத்தும் போட்டிகள்**

நேரம்: காலை 10:00 மணி

நாள்: 05.01.2023

இடம்: தமிழ்த் துறை

கவிதை: தையலை உயர்வு செய்

கட்டுரை: நலிந்தவர் மேம்பட நல்லறம்  
புரிந்த நல்லாள்

பேச்சுப்போட்டி: மாதர் அறம்

14:31

See more chat  
history on the  
app  
Get WhatsApp  
for Windows

Type a message



- Chats
- ← பேச்சுப் ✕
- All Unread
- Groups

CHATS

- பே... 3/4/2024  
Dr.: Photo
- 2 ... 2/15/2024  
+91 86681 5...
- பே... 1/3/2024  
Dr.: தமிழ்த் ...

MESSAGES

"யாதும் ... 3/23/2024  
+91 85089 06053: உ.

Dr. Lakshmi 3/13/2024  
போட்டி நடத்துபவ...

+91 93424 ... 2/13/2024  
Follow this link to j...

பேச்சுப் ... 1/3/2024  
Dr.: தமிழ்த் துறை ந...

Your personal messages

See more chat history on the app  
Get WhatsApp for Windows



பேச்சுப் போட்டி குழு  
Dillybabu, Dr., Lekha, Sangavai...



Click here to get older messages from your phone.

3/4/2024



Dr. Lakshmi  
Forwarded



19:37



Type a message

PRINCIPAL,  
DHARMAMURTHI RAO BAHADUR CALAVALA CUNNU  
CHETTY'S HINDU COLLEGE  
DHARMAMURTHI NAGAR, PATTABIRAM,  
CHENNAI - 600 072.



தருமலூர்த்தி இராய்க்குடும்ப கல்வியை கண்ணன் செட்டி இந்துக்கல்லூரி

தேசியத் துறைமுகம் குழுவினர் B+ தகுதி பெற்றது  
தருமலூர்த்தி நகர், பட்டாபரம்ப, சென்னை - 600 072.  
காஞ்சி - 1

On 10/08/23  
Staff circular  
2  
Jeyalents

தமிழ்த்துறை மற்றும் தமிழ் இணையக் கல்விக் கழகம்  
இணைந்து நடத்தும்  
**கணித்தமிழ்ப் பேரவை - பயிலரங்கம்**

நாள்: 18.08.2023 நேரம்: காலை 10.00 மணி இடம்: தருமலூர்த்தி கண்ணன் அறை

ஹேவ்ஹேவ்

க. பேரி

முதுமுனைவர், தமிழ்த்துறை

தலைமையுரை

முனைவர் க. கல்விக்கரசி  
முதுமுனைவர்

பயிற்றுநர் உரை

திரு. கல்வி ஜாகீர்

VGLUG Volunteer - Lead Android Engineer @ Remitbee.



அமர்வு - 1

தமிழ் மென்பொருள் உருவாக்கப் பயிற்சி

அமர்வு - 2

தமிழ்க் குறும்புசெயலி உருவாக்கப் பயிற்சி

நன்றியுரை

முதுமுனைவர் க.லட்சுமி

அனைவரும் வருக !!!

தமிழ்த்துறைப் பேராசிரியர்கள் மற்றும் கணித்தமிழ்ப் பேரவை மாணவர்கள்

க. பேரி

முனைவர் க. கல்விக்கரசி

திரு M. வெங்கடேசபெருமாள்

திரு. சங்கை

முதுமுனைவர்

செயலி

அனைத்து மாணவர்கள்  
கணித்தமிழ்ப் பேரவை

அறங்காவலர் குழுவினர்

திரு. ரமேஷ் சித்தரல்லா, தலைவர் திரு. M.V. கன்னையச் செட்டி, அங்குள்ள அறங்காவலர் திரு. C. வெங்கடேசலம்

திரு. M. வெங்கடேச பெருமாள், உறுப்பினர் டாக்டர். பிரவீன் தெல்லகலா

திரு. R. பாலாஜி குப்தா திரு. G. சந்திரமோகன் திரு. B. கௌதம்

2008/14/4 Comm. V. No. 18/12/23

STAFF ORDER NO : / STAFF CIRCULAR Dt/NOTICE No:

Teaching staff















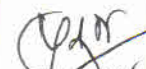





Dr.Smt. G.K. _____	Ms. K.B. <u></u>	Smt.S.M.S. <u></u>
Dr.Smt. K.L. <u></u>	Dr.Smt. M.K.S. <u></u>	Sri R.B.S. <u></u>
Dr.Smt. T.M.G. <u></u>	Dr.S.B.S. <u></u>	Dr.Smt.N.J.S. <u></u>
Dr.Smt.S.P. <u></u>	Dr.R.J. <u></u>	Dr.AVI <u></u>
Dr.M.S. <u></u>	Dr.Smt.T.K. <u></u>	Smt. V.K. <u></u>
Sri V.V. <u></u>	Dr.S.V.M. <u></u>	Dr.Smt.V.S. <u></u>
Sri S.S. <u></u>	Dr.N.M. <u></u>	Ms. MH. <u></u>
Sri L.H.K. <u></u>	Smt. N.K. <u></u>	Dr.Smt.A.I. <u></u>
Dr.Smt.C.Y. <u></u>	Dr.M.J.N. <u></u>	Dr.Smt.K.B.S. <u></u>
Dr.Smt.R.J.S. <u></u>	Dr.Smt.R.R. <u></u>	Dr.R.S.P. <u></u>
Dr.S.S.K. <u></u>	Dr.G.B. <u></u>	Dr.Smt.D.L. _____
Dr.Smt.Z.B. <u></u> 18/12/23	Dr. K.S. <u></u>	Dr. M.K <u></u>

Teaching staff (Management Appointees)

Dr.Smt. C.M. _____	Smt. D.P. _____	Sri S.A. <u></u>
Sri V.D.R <u></u>	Ms.D.D.R <u></u>	Sri M.M <u></u>

To

**All Classes**

CLASS	I YEAR	II YEAR	III YEAR
B.A.HISTORY			
B.A.ECONOMICS			
B.A.ENGLISH			
B.A.TELUGU			
B.COM.CORP.SEC.			
B.Sc. MATHEMATICS			
B.COM			

தருமமூர்த்தி இராவ் பகதூர் கலவல கண்ணன் செட்டி இந்துக்கல்லூரி  
பட்டாபிராம், சென்னை - 600072 (சுழற்சி -1)

தமிழ்த்துறை மற்றும் தமிழ் இணையக் கல்விக்கழகம்

இணைந்து நடத்தும்

கணித்தமிழ்ப் பேரவை- பயிலரங்கம்

நாள்:18.08.2023 நேரம்: காலை 10:00

- தமிழ்த்தாய் வாழ்த்து மாணவர்கள்
- வரவேற்புரை பேராசிரியர் க.பேபி  
தமிழ்த்துறைத்தலைவர்
- தலைமையுரை முனைவர்க. கல்விக்கரசி,  
முதல்வர்
- சிறப்பு விருந்தினருக்குச் சிறப்புச் செய்தல்
- அறிமுகவுரை பேராசிரியர் ச.மு.சங்கவை, உதவிப்பேராசிரியர்
- சிறப்புரைஉரை : திரு. கலீல்ஜாகிர்  
இணைய வல்லுநர்
- நன்றியுரை முதுமுனைவர் கா.இலட்சுமி, உதவிப்பேராசிரியர்
- நாட்டுப்பண்

கணினித் தமிழ்ப் பேரவை - பயிலரங்கம் 18.08.2023



*C. Valimurthy*  
PRINCIPAL,  
DHARMAMURTHI RAO BHADUR CALAYALA CUNNAM  
CHETTY'S HINDU COLLEGE  
DHARMAMURTHI NAGAR, PATTABIRAM,  
CHENNAI - 600 072.

# பட்டாபிராம் இந்து கல்லூரியில் கணினி தமிழ் பயிற்சி



பட்டாபிராம், தரும மூர்த்தி இராவ் பகதூர் கலவல கண்ணன் செட்டி இந்து கல்லூரி தமிழ்துறை (கழற்சி- கணினித் தமிழ் பேரவை சார்பில் "ஆண்டராய்ட் தொழில் நுட்பமும் பயன்பாடுகளும்" என்னும் பொருளில் ஒரு நாள் பயிலரங்கம் நடைபெற்றது. கணினி தமிழ் வல்லுநர் கல் ஜாகீர் ஆண்டராய்டு கருவிகள், வளப்படுத்தும் கருவிகள், ஜாவா, கோட்லின் உள்ளிட்ட கணினி மொழிகளின் பயன்பாடுகள் குறித்தும் தொலை நோக்கிலான இணைய சிந்தனைகளை வளர்க்கும் நோக்கிலும் மாணவர்களுக்கு பயிற்சியளித்தார். கல்லூரி முதல்வர் முனைவர் க.கல்விக்காசி தலைமையேற்று பயிற்சி வகுப்பை தொடங்கிவைத்தார். முன்னதாக தமிழ் துறை தலைவர் பேராசிரியர் க.பேரி வரவேற்று பேசினார். மாணவர்கள் கணினியை தமிழ் மொழியிலேயே பயன்படுத்தும் நோக்கிலும் இணைய தமிழை வளர்த்தெடுக்கும் நோக்கிலும் இந்து கல்லூரியில் கணினித்தமிழ்ப் பேரவை, தமிழ் இணைய கழகத்தின் நிதிநல்கையுடன் கடந்த ஆண்டு தொடங்கப்பட்டது. மாணவர்களுக்கான கணினி தமிழ் பயிற்சிகளை இப்பேரவை தொடர்ந்து வழங்கி வருகிறது. 125 மாணவர்கள் பேரவையில் உறுப்பினர்களாக இருந்து இப்பயிற்சியை பெறுகின்றனர்



PRINCIPAL,

DHARMAMURTHI RAO BHADUR CALAVALA CUNNAM  
CHETTY'S HINDU COLLEGE

DHARMAMURTHI NAGAR, PATTABIRAM.

# பின்னூட்டப் படிவம்

## கணித்தமிழ்ப் பேரவை - பயிலரங்கம்

## பயிலரங்கப் பொருண்மை:

## ஆண்ட்ராய்டு மென்பொருள்

நாள்:

18.08.2023

இன்றைய நிகழ்வின்  
சிறப்பு விருந்தினர் திரு  
கல்ல ஜாகிர் பயிற்சி  
உரை

Copy

82 responses

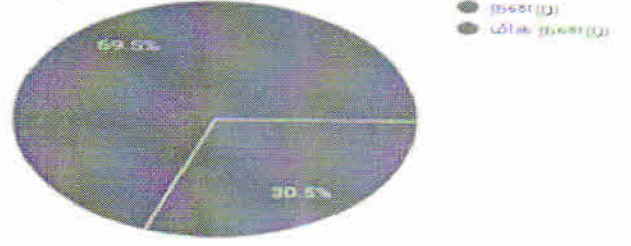

ஆண்ட்ராய்டு  
மென்பொருள் குறித்த  
புரிதலை இந்நிகழ்வு  
ஏற்படுத்தியதா?

Copy

82 responses

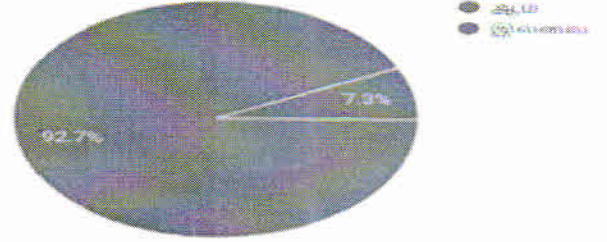

இணையத்தில்  
சந்தைப்படுத்தல்  
பயனுள்ளதா?

Copy

82 responses

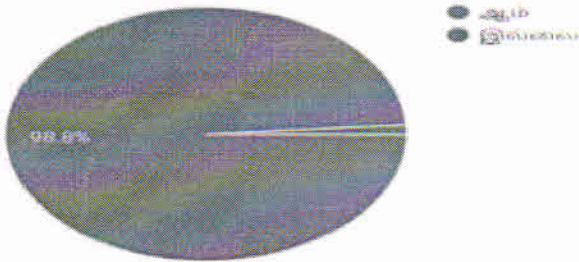

கணினி மொழி சார்ந்த  
மென்பொருளை  
அறிவது பணிவாய்ப்பை  
ஏற்படுத்தும்

Copy

81 responses

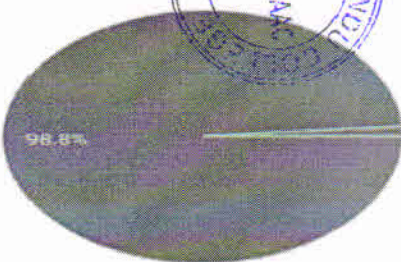

ஆம்  
இல்லை

PRINCIPAL,  
DHARMAMURTHI RAO BANGALURU CALAVALA GUNNAR  
CHETTY'S COLLEGE  
DHARMAMURTHI RAO BAR, PATTABIRAM,  
CHENNAI - 600 072.

பயிலரங்க  
ஒருங்கிணைப்பு

Copy

82 responses

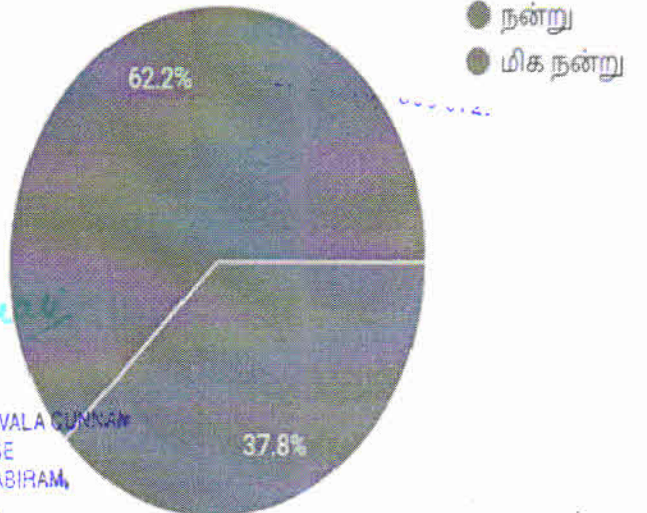



தரும மூர்த்தி இராஜமதுர் கல்வியை கண்ணன் செட்டி இந்துக்கல்லூரி

தேசியத் தமிழ் கல்வித் துறையின் B+ தகுதி பெற்றது  
தருமமூர்த்தி நகர், உட்பாளையம், சென்னை - 600 072.

கட்டிடம் - 1

Circular to students & Staff

Cell  
30/1/23

தமிழ்த்துறை மற்றும் தமிழ் இணையக் கல்விக் கழகம்

இணைந்து நடத்தும்

**கணித்தமிழ்ப் பேரவை - கணினித் திருவிழா**

நாள்: 31.08.2023 நேரம்: காலை 10.00 மணி இடம்: கண்ணன் அரங்கம்

வரவேற்புரை

க. பேயி

துறைத்தலைவர், தமிழ்த்துறை

தலைமை

முனைவர் க. கல்விக்கரசி  
முதல்வர்

சிறப்புரைகள்

திரு. 'நீச்சல்காரன்' இராஜாராமன்

தொழில்நுட்ப வல்லுநர், முதலமைச்சர் கணினித்தமிழ் விருநாளர்.

திரு. மு.சு. அருண்குமார்

ஆய்வு வளமையர், கணித்தமிழ்ப்பேரவை  
& தமிழ்ப் பெருங்களஞ்சியத் திட்டம்  
தமிழ் இணையக் கல்விக் கழகம், சென்னை

நன்றியுரை

முதுமுனைவர் மு.கஸ்தூரி

அனைவரும் வருக !!!

தமிழ்த்துறைப் பேராசிரியர்கள் மற்றும் கணித்தமிழ்ப் பேரவை மாணவர்கள்

க. பேயி

ச.மு.சங்கவை

முனைவர் க. கல்விக்கரசி  
முதல்வர்

முனைவர் க. கல்விக்கரசி  
முதல்வர்

திரு M. வெங்கடேசபெருமாள்

செயலர்

அறங்காவலர் குழுவினர்

திரு. ரமேஷ் சித்தரல்லா, நயனார் திரு. M.V. கன்னையச் செட்டி, அழகன் அறங்காவலர் திரு. C. வெங்கடாசலம்

திரு. M. வெங்கடேச பெருமாள், கல்லூரி செயலர் பாக்டர். பிரவீன் தெல்லகுவா

திரு. R. யாலாஜி குப்தா திரு. G. சந்திரமோகன் திரு. B. கௌதம்

## கணித்தமிழ்ப் பேரவை - கணினித் திருவிழா

தரும மூர்த்தி இராவ் பகதூர் கலவல கண்ணன் செட்டி இந்துக்கல்லூரியின் தமிழ்த்துறை(சுழற்சி-1), தமிழ் இணையக் கல்விக் கழகத்தின் நிதிநல்கையுடன் கணித்தமிழ்ப் பேரவையைத் தொடங்கி, நூற்றி இருபத்தைந்து மாணவர்களை உறுப்பினர்களாகக் கொண்டு, திறம்பட இணையத் தமிழ்ப் பணி ஆற்றிவருகிறது. நமது கல்லூரிக் கணித்தமிழ்ப் பேரவை சார்பில் மாணவர்கள் கணினியைத் தமிழ் மொழியிலேயே பயன்படுத்தும் நோக்கிலும் இணையத் தமிழை வளர்த்தெடுக்கும் நோக்கிலும் 31.08.2023 அன்று கணினித் திருவிழா நடைபெற்றது. இந்நிகழ்வின் ஒருங்கிணைப்பாளர் தமிழ்த்துறைத் தலைவர் பேராசிரியர் க.பேபி அவர்கள் வரவேற்புரை வழங்கினார். தமிழ்த்துறைப் பேராசிரியர் முதுமுனைவர் கா.இலட்சுமி அறிமுகவுரை வழங்கினார். பன்னாட்டு நிறுவனத்தின் கணினித் தொழில்நுட்ப வல்லுநரான திரு. நீச்சல்காரன் ராஜாராமன் அவர்கள் "தமிழ் இணையதளம் உருவாக்கம்" என்னும் பொருண்மையில் இணையதளம் உருவாக்கத்தின் பயன்கள், உருவாக்கும் முறை, மொழி நோக்கிலான பயன்பாடு, பல்லாடகத் தொடர்பு, பணிவாய்ப்பு குறித்து இணையம் வழியாக மாணவர்களோடு கலந்துரையாடி, மாணவர்களின் ஐயங்களுக்கு வழிகாட்டினார்.

தமிழ் இணையக் கல்விக் கழகத்தின் ஆய்வு வளமையரான திரு மு.சு. அருண்குமார் சிறப்பு விருந்தினராய்க் கலந்து கொண்டு மாணவர்களுக்குத் தமிழ் இணையதளங்கள் பற்றிய அறிமுகமும் கணினி வழி தமிழை அணுகும் முறைகள், பயன்பாடுகள் குறித்தும் விளக்கினார். இணையச் சிந்தனைகளை வளர்க்கும் நோக்கில் மாணவர்களுக்குத் தமிழ்க் கணிமை போட்டிகள்,

1. வலைப்பக்கம்(webpage) அல்லது வலைப்பூ (Blog) உருவாக்கம்  
தலைப்பு: உன்னால் முடியும்
2. போன்மி (memes) உருவாக்கம்  
தலைப்பு: சந்திராயன்-3
3. காட்சி நிகழ்த்துகை (ppt) உருவாக்கம்  
தலைப்பு: கணினி- தலைமுறைகள்
4. முப்பரிமாண மாதிரி வடிவமைப்பு (3D models)  
தலைப்பு: தமிழர் கட்டிடக்கலை
5. குறும்படம் (shortfilm) உருவாக்கம்  
தலைப்பு: தோன்றின் புகழோடு தோன்றுக

என்னும் பன்முக தன்மையில் நடத்தப்பட்டன. பரிசு பெற்ற மாணவர்களுக்குச் சிறப்பு விருந்தினர் பரிசுகள் வழங்கிச் சிறப்பித்தார். கணினி மாதிரிகள் கண்காட்சி கணினி திருவிழாவில் இடம் பெற்றது நிகழ்வின் நிறைவாக, தமிழ்த்துறைப் பேராசிரியர் முதுமுனைவர் மு.கஸ்தூரி நன்றியுரை வழங்கினார். கல்லூரியின் தமிழ்த் துறைப் பேராசிரியர்கள் கலந்து கொண்டு ஊக்கப்படுத்தினர். மாணவர்களின் இணையப் பயன்பாட்டுத் திறத்தை வளர்ப்பதற்கு இக்கணினித் திருவிழா நல்களமாய் அமைந்தது.

தமிழ்க் கணிமை - போட்டிகள்

- தனிநபர் போட்டிகள்

1. வலைப்பக்கம்(webpage) அல்லது வலைப்பூ (Blog) உருவாக்கம்

தலைப்பு: உன்னால் முடியும்

- ஒரு வலைப்பக்கத்தை உருவாக்கி, உன்னால் முடியும் என்ற தலைப்பில் ஒரு பத்தியை தமிழ் அல்லது ஆங்கிலத்தில் பதிவிடல்.

2. போன்மி (memes) உருவாக்கம்

தலைப்பு: சந்திராயன்-3

- தமிழ் அல்லது ஆங்கிலத்தில் போன்மி உருவாக்குதல்

3. காட்சி நிகழ்த்துகை (ppt) உருவாக்கம்

தலைப்பு: கணினி- தலைமுறைகள்

- தமிழ் அல்லது ஆங்கிலத்தில் உருவாக்குதல்

4. முப்பரிமாண மாதிரி வடிவமைப்பு (3D models)

தலைப்பு: தமிழர் கட்டிடக்கலை

- தமிழர் கட்டிடக்கலையை எடுத்துரைக்கும் நோக்கில் முப்பரிமாணத்தில் உருவ மாதிரியை உருவாக்குதல்.

- குழு போட்டி

5. குறும்படம் (shortfilm) உருவாக்கம்

தலைப்பு: தோன்றின் புகழோடு தோன்றுக

- தமிழ் அல்லது ஆங்கிலத்தில் ஒரு நிமிடத்தில் குறும்படம் உருவாக்குதல்.  
(குழுவில் மூவர் முதல் ஐவர் வரை பங்கேற்கலாம்.)

கணிளித் தமிழ்ப் பேரவை - திருவிழா 31.08.2023

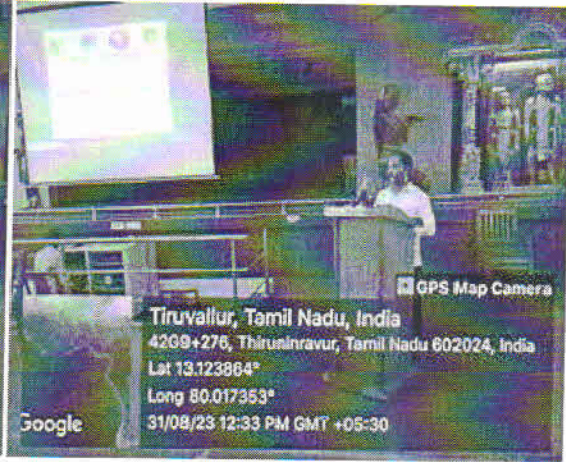

*C. Kalinay*  
PRINCIPAL,  
DHARMAMURTHI RAO BAHADUR CALAVALA CUNNAM  
CHETTY'S HINDU COLLEGE  
DHARMAMURTHI NAGAR, PATTABIRAM,  
CHENNAI - 600 072.

# கணித்தமிழ்ப் பேரவை- கணினித் திருவிழா

நாள்: 31.08.2023  
20 responses

இன்றைய நிகழ்வின்  
சிறப்பு விருந்தினர் திரு.  
நீச்சல்காரன் ராஜாராமன்  
உரை  
20 responses

Copy

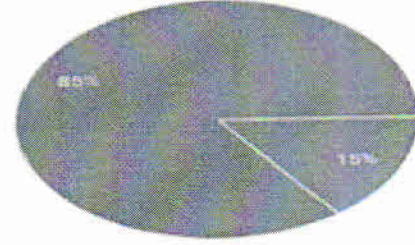

● நன்று  
● மிக நன்று

இணையத் தமிழ்  
மென்பொருள் குறித்த  
புரிதலை இந்நிகழ்வு  
ஏற்படுத்தியதா?  
20 responses

Copy

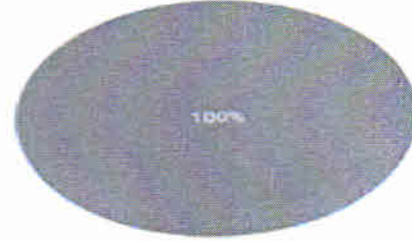

● ஆம்  
● இல்லை

இணையப் போட்டிகள்  
20 responses

Copy

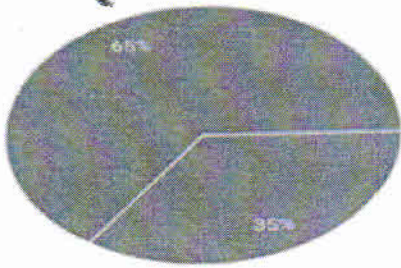

● நன்று  
● மிக நன்று

இணைய வலைத்தளம்  
குறித்த புரிதலை  
இந்நிகழ்வு  
ஏற்படுத்தியது  
20 responses

Copy

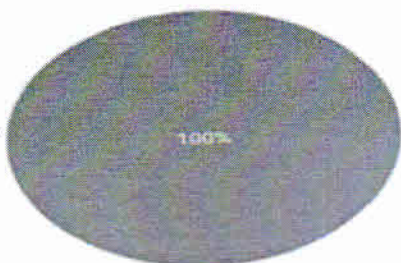

● ஆம்  
● இல்லை

பயிலரங்க  
ஒருங்கிணைப்பு,  
கருத்துக்கள் குறித்த  
கருத்த  
20 responses

Copy

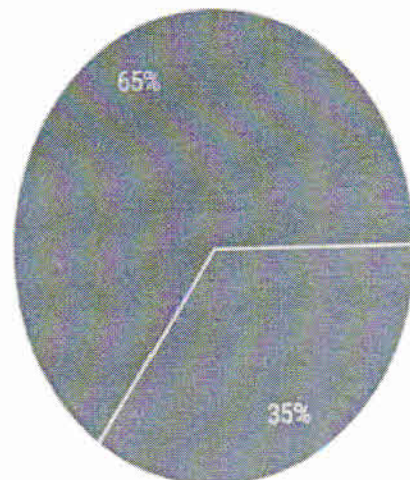

● நன்று  
● மிக நன்று



**DHARMAMURTHI RAO BAHADUR  
CALAVALA CUNNAN CHETTY'S HINDU COLLEGE**  
"LINGUISTIC (TELUGU) MINORITY STATUS  
CONFERRED BY THE GOVERNMENT OF TAMIL NADU"  
(SHIFT 1 - GOVT. AIDED)



Re-accredited by NAAC with B+ Grade - Affiliated to University of Madras  
DHARMAMURTHI NAGAR, PATTABIRAM, CHENNAI - 600 072.  
Phone: 044-26850621  
[www.drbecchinducollege.ac.in](http://www.drbecchinducollege.ac.in) E-mail: [hc1@drbecchinducollege.edu.in](mailto:hc1@drbecchinducollege.edu.in)

Sri M. Venkatesaperumal, B.A., F.C.A.,  
Secretary

Dr.(Smt.) G. Kalvikkarasi, M.A., M.Phil., Ph.D.,  
Principal

தேதி: 29.08.2023

**சுற்றறிக்கை**

தமிழ்த்துறை மற்றும் தமிழ் இணையக் கல்விக்கழகம் இணைந்து நடத்தும் கணித்தமிழ்ப் பேரவை சார்பில் தமிழ்க்கணிமை - போட்டிகள் 30.08.2023 அன்று நடைபெறும். அப்போட்டிகளில் பங்கு கொள்ளும் மாணவர்கள் தமிழ்த் துறையை அணுகவும்.

போட்டிகள் தொடர்பான விவரம் வ ருமாறு.

தனிநபர் போட்டிகள்

1. வலைப்பக்கம் (webpage) அல்லது வலைப்பு (Blog) உருவாக்கம்
2. போன்மி (memes) உருவாக்கம்
3. காட்சிநிகழ்த்துகை (ppt) உருவாக்கம்
4. முப்பரிமாண மாதிரி வடிவமைப்பு (3D models)

குழுபோட்டி

5. குறும்படம் (shortfilm) உருவாக்கம்

  
ஒருங்கிணைப்பாளர்

  
முதல்வர்  
DHARMAMURTHI RAO BAHADUR CALAVALA  
CUNNAN CHETTY'S HINDU COLLEGE  
DHARMAMURTHI NAGAR,  
PATTABIRAM, CHENNAI - 600 072.

வாரியம்	பெயர்	வகுப்பு	பங்களிப்பும் பிள்ளை
43547	ஆ. ம. வித்திகா	I <sup>st</sup> B. Com (General)	PPT, Blog, Word press
43566	ம. வேதகார்த்தினி	I <sup>st</sup> B. Com (General)	Blog, Word press, PPT
43342	பா. கிருத்திகா	I <sup>st</sup> B. Com (CS)	PPT
43338	ஜாய் பெர்சி. ரா	I <sup>st</sup> B. Com (C.S)	PPT
43341	ம. சீர்த்திகா	I <sup>st</sup> B. Com (CS)	PPT
43326	ஆ. அர்ச்சுனா	I <sup>st</sup> B. Com (CS)	PPT
43327	சு. தார்ஜினி	I <sup>st</sup> B. Com (CS)	Wordpress, PPT
43321	கு. சிகர்சன்	I <sup>st</sup> B. Com (CS)	Wordpress.
43320	நா. சீனிவாசன்	I <sup>st</sup> B. Com (CS)	PPT, <del>Blog</del>
43302	செ. ஜெ. பரஞ்சுலா	I <sup>st</sup> B. Com (C.S)	Wordpress, PPT
42112	கு. சந்திரா	II <sup>nd</sup> B. A ELO	PPT, Memes
42102	செ. சந்திரா சிவா	II <sup>nd</sup> B. A ELO	Wordpress, Memes.
42125	ஆ. அர்ச்சுனா	II <sup>nd</sup> B. A ELO	PPT,
42124	M. ஆபிரீன் பாஷா	II-nd B. A ELO	PPT
42136	P. Gopika	II-nd B. A ELO	PPT, MEMES
42114	செ. அஸ்வினி	II - B. Sc. Maths	Blog, PPT
42164	செ. வைஷ்ணவி	II - B. Sc. Maths	Webpage or Blog
42127	செ. பொ. பொ. பொ. பொ.	II - B. Sc. Maths	Blog, PPT PPT.
42136	மா. நீத்யா	II - B. Sc. Maths	Webpage, PPT.
42141	மா. அர்ச்சு	II B. Sc Maths	Web page, PPT
42123	இந்திரா. கு	II B. Sc Maths	Webpage, PPT
42116	மா. புவனேஸ்வரி	II BSC Maths	webpage, ppt
42116	சி. சீபிகா	I BA. English	memes
4227	ஜெ. ஜெ. ஜெ. ஜெ.	I. B.A English	Wordpress.
4231	கவிதா. ச	I. BA English	memes, PPT
434	ச. காமியா	III 3rd year Bsc Maths	
4468	மா. நிஷித்	III 3rd year Bsc. Math	
4403	ஆ. அர்ச்சு	III 3rd Bsc Maths	



**C. Aravinthan**  
 PRINCIPAL,  
 CHETTY'S HINDU COLLEGE,  
 CHARMAMURTHI NAGAR, PATTABIRAM,  
 CHENNAI - 600 072.

2.3.2.

## Department Of B.Com(Ism)

### ICT TOOLS

**Dr. Premila Koppalakrishnan, HOD**



*C. Kalinraaj*  
PRINCIPAL,  
DHARMAMURTHI RAO BHADUR CALAVALA CUNNAM  
CHETTYS HIGHER SECONDARY COLLEGE  
DHARMAMURTHI NAGAR, PATTASIRAM,  
CHENNAI - 600 072.

**Academic Year**

**2023-2024**



# Classroom > BCOM SECOND YEAR



Stream

**Classwork**

People

Grades



Create

All topics

REVISION

Edited Mar 19



REVISION

Posted Mar 19



QUIZ

Posted Mar 19



HOLIDAY HOMEWORK

Posted Mar 19



case study



INDIVIDUAL ASSIGNMENT ----- CA...

Due Feb 15, 11:59 PM





Stream

Classwork

People

Grades



Customize

# BGE-CSC19 ENTREPRENEURIAL D...



Announce something to your class



premila koppalakrishnan

Apr 11



Pradhan Mantri Jan Dhan Yojana

Various subsidies provided to small-scale industriesSIDCO

Pradhan Mantri Jan Dhan Yojana

frequently repeate...

Google Slides



Add class comment...



premila koppalakrishnan

Apr 11 (Edited Apr 11)



**Various subsidies provided to small-scale industries**

Top Government Business Loan Schemes in India

10 Best Government Subsidies for Small Business



Top 5 Government ...

<https://groww.in/blog/to>



10 Best Governme...

<https://smeventure.com/>





Stream

Classwork

People

Grades



premila koppalakrishnan  
Mar 30 (Edited Mar 30)



PREVIOUS YEAR QUESTION PAPER



NOV-2017\_CPM3D...  
PDF



NOV-2018\_CPM3D...  
PDF



APR-2018\_CPM3D...  
PDF



APR-2019\_CPM3D...  
PDF



NOV-2020\_CPM3D...  
PDF



APR-2021\_CPM3D...  
PDF



2 MARKS ANSWER...  
PDF



Add class comment...



premila koppalakrishnan  
Mar 30



Additional notes from the book



Adobe Scan Mar 27...  
PDF



Adobe Scan Mar 27...  
PDF

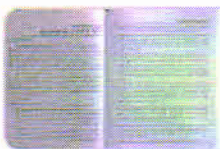

unit2.pdf  
PDF



unit 3.pdf  
PDF

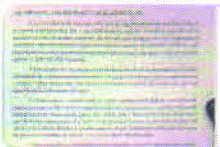

unit 4.pdf  
PDF

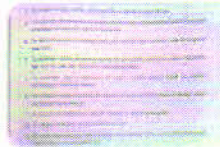

unit 5.pdf  
PDF



Classroom > BGE-CSC19 ENTREPRENEUR...



Stream Classwork People Grades



premila koppalakrishnan  
Mar 22



DIGITAL NOTES OF UNITS



UNIT-1 ED -FINAL.p...  
PowerPoint

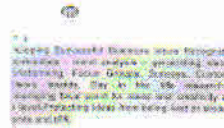

UNIT-2 ED -FINAL....  
PowerPoint



UNIT-3 ED-FINAL.p...  
PowerPoint

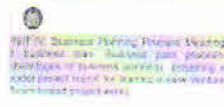

UNIT-4-ED -FINAL....  
PowerPoint

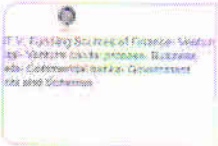

UNIT-5 ED-FINAL.p...  
PowerPoint



Add class comment...



premila koppalakrishnan  
Mar 21



Entrepreneurial Development  
Program(EDP):

NOTES ED

NOTES ED.pdf  
PDF



Add class comment...



premila koppalakrishnan  
Mar 20 (Edited Mar 21)



REVISION PORTION





# Classroom > BGE-CSC19 ENTREPRENEURI...



Stream

Classwork

People

Grades



PDF



PDF

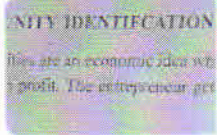

**STEP IN OPPORTU...**  
PDF

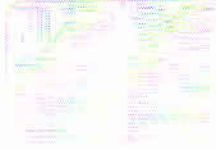

**PROJECT REPORT ...**  
PDF

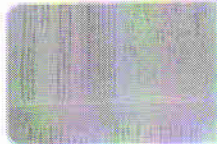

**FUNCTION OF ENT...**  
PDF



**OBJECTIVES OF SI...**  
PDF



**ROLE OF ENTREPR...**  
PDF



**TYPES OF ENTREP...**  
PDF



**CONTENT OF EDPs...**  
PDF



**CONCEPT OF ENT...**  
PDF

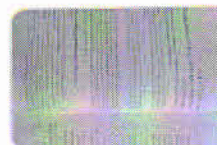

**ENTREPRENEURIAL...**  
PDF



**CONTACT OF WO...**  
PDF



Add class comment...



**premila koppalakrishnan**  
Mar 18



Differences between Angel Investor and Venture Capitalist



Add class comment...



**premila koppalakrishnan**  
Mar 18



Angel investors





Stream Classwork People Grades



Add class comment...



premila koppalakrishnan

Mar 17



ROLE OF COMMERCIAL BANKS FOR THE DEVELOPMENT OF ENTREPRENEURSHIP



ROLE OF COMMER...

PDF



Add class comment...



premila koppalakrishnan

Mar 14



List of Government Schemes to Support Startups in India GOVERNMENT INITIATIVES FOR STARTUP



List Of Governmen...

<https://startuptalky.com>,



Add class comment...



premila koppalakrishnan

Mar 12



Women Entrepreneurs Shaping The Future Of India



Women Entreprene...

YouTube video • 11 minu



*C. Kalinmurai*  
PRINCIPAL,  
DHARMAMURTHI RAO RAHADUR CALAVALA CUNNAN  
CHETTIN'S ROAD, COLLEGE  
DHARMAMURTHI NAGAR, PATTABIRAM,  
CHENNAI - 600 072.





Stream

Classwork

People

Grades



premila koppalakrishnan  
Mar 12



Entrepreneurship in young age | Vinusha M.K | TEDxKanniyakumari



At 10, this Chennai ...  
YouTube video • 7 minute



Entrepreneurship i...  
YouTube video • 5 minute



Add class comment...



premila koppalakrishnan  
Mar 12



Top 10 Successful Young Entrepreneurs in India – 2024



Top 10 Successful Y...  
<https://ponnusamykarthi>



Add class comment...



premila koppalakrishnan  
Mar 12



Top 10 Indian Entrepreneurs

1. Dhirubhai Ambani

Dhirubhai Ambani(1932–2002) is an Indian businessman who started humbly by selling traditional snacks to religious pilgrims. His business soon grew, and he expanded and diversified into industries including telecommunications, power generation, information technology, consumer goods, and logistics.1

Today, Reliance Industries is India's largest private company and is listed on the Fortune 500.2 Ambani's son now runs Reliance and is one of India's wealthiest people; Mukesh Ambani, 65, is worth \$92.5 billion, according to Forbes.

2. Jehangir Ratanji Dadabhoi Tata

Jehangir Ratanji Dadabhoi Tata or JRD Tata (1904–1993) was born in Paris to Indian and French parents. He was trained as an aviator in Europe and later became India's first commercial airline pilot. Working for the family business, TATA group, he set out on his own and built TATA Airlines, which ultimately became the





Stream

Classwork

People

Grades



Add class comment...



premila koppalakrishnan

Dec 28, 2023



10 Characteristics of Successful Entrepreneurs



10 Characteristics ...

<https://online.hbs.edu/bl>



Add class comment...



premila koppalakrishnan

Dec 28, 2023 (Edited Jan 16)



Welcome back! I am sure you had a great break before joining the classroom online . It's now time to look forward to a year that makes wonderful memories.

Welcome to the Entrepreneurial Development course. Embark on a learning and entrepreneurial journey at the forefront of your aspirations.



Add class comment...



*G. valinnaray*  
PRINCIPAL,  
DHARMAMURTHI RAO BHADUR CALAVALA CUNNAM  
CHETTY'S HINDU COLLEGE  
DHARMAMURTHI NAGAR, PATTABIRAM,  
CHENNAI - 600 072.



**DHARMAMURTHI RAO BAHADUR CALAVALA CUNNAN CHETTY'S**  
**HINDU COLLEGE**

**DEPARTMENT OF B.COM(ISM)**

**Information and Communication Technology**

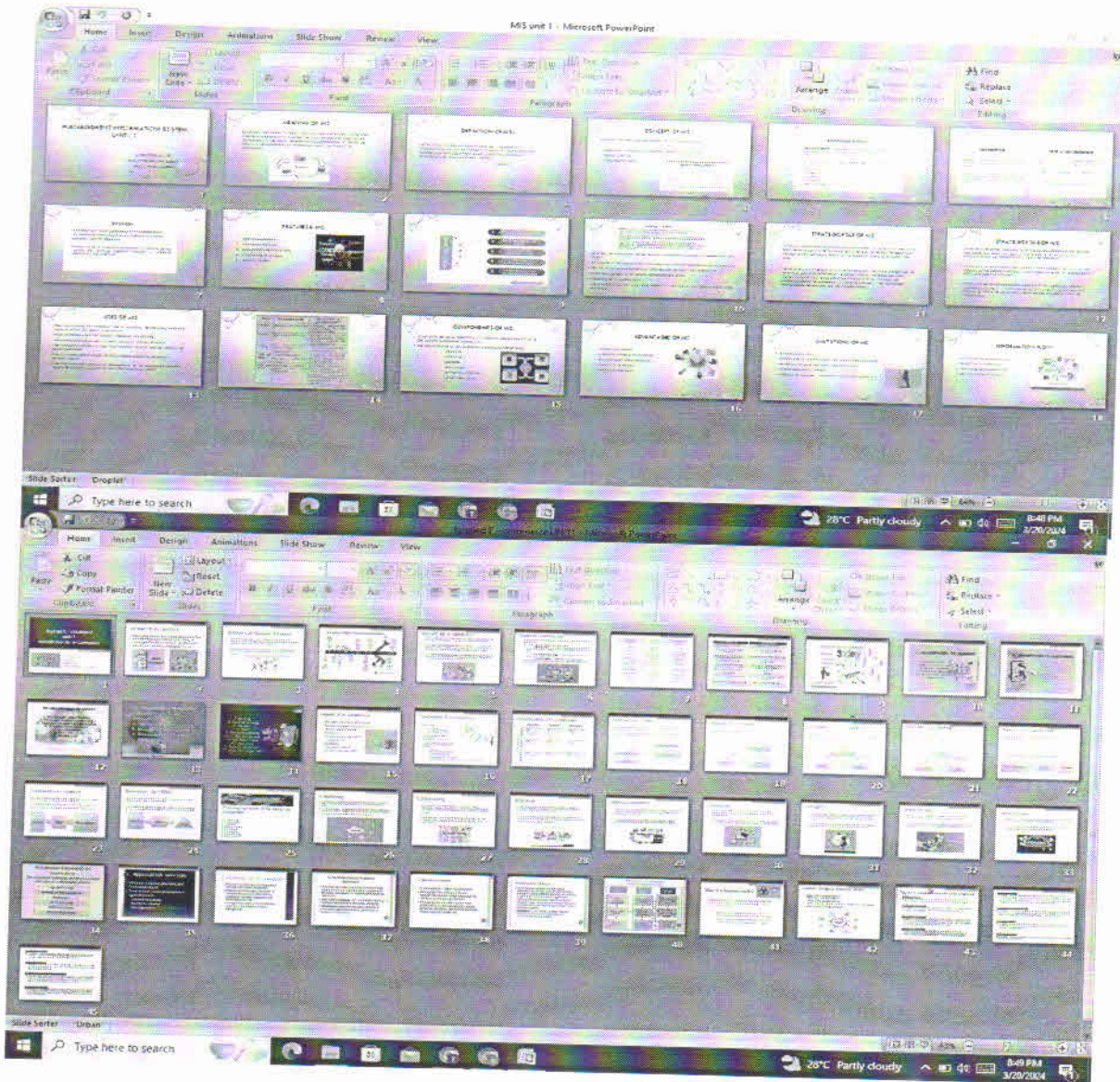

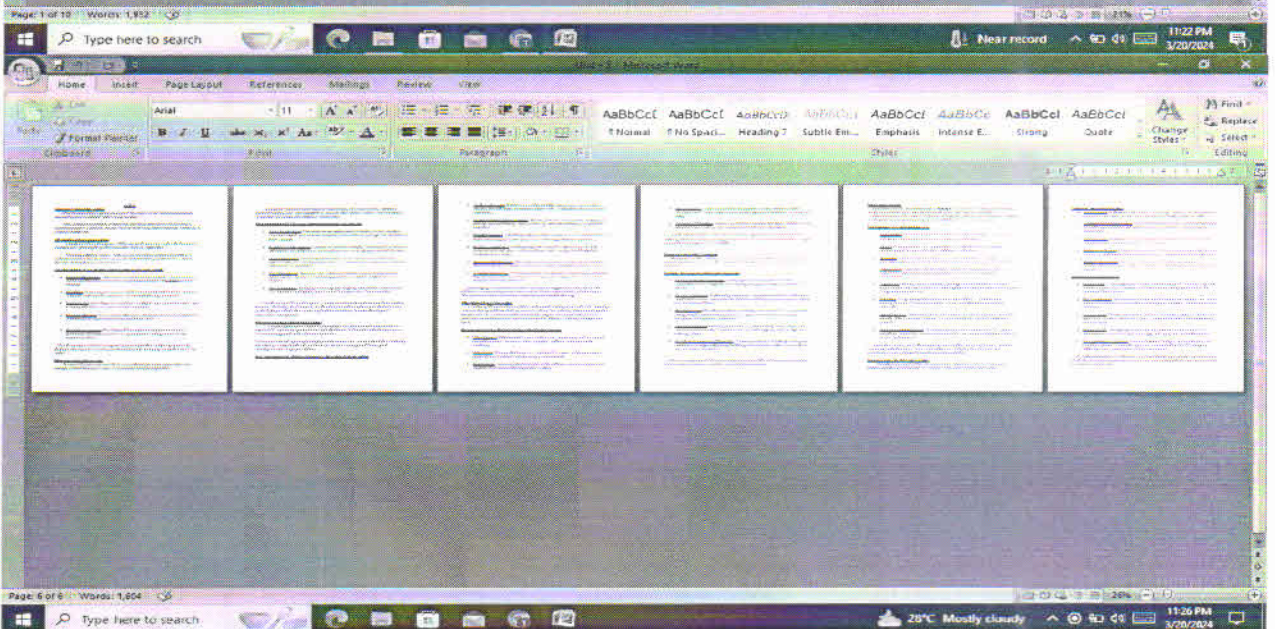
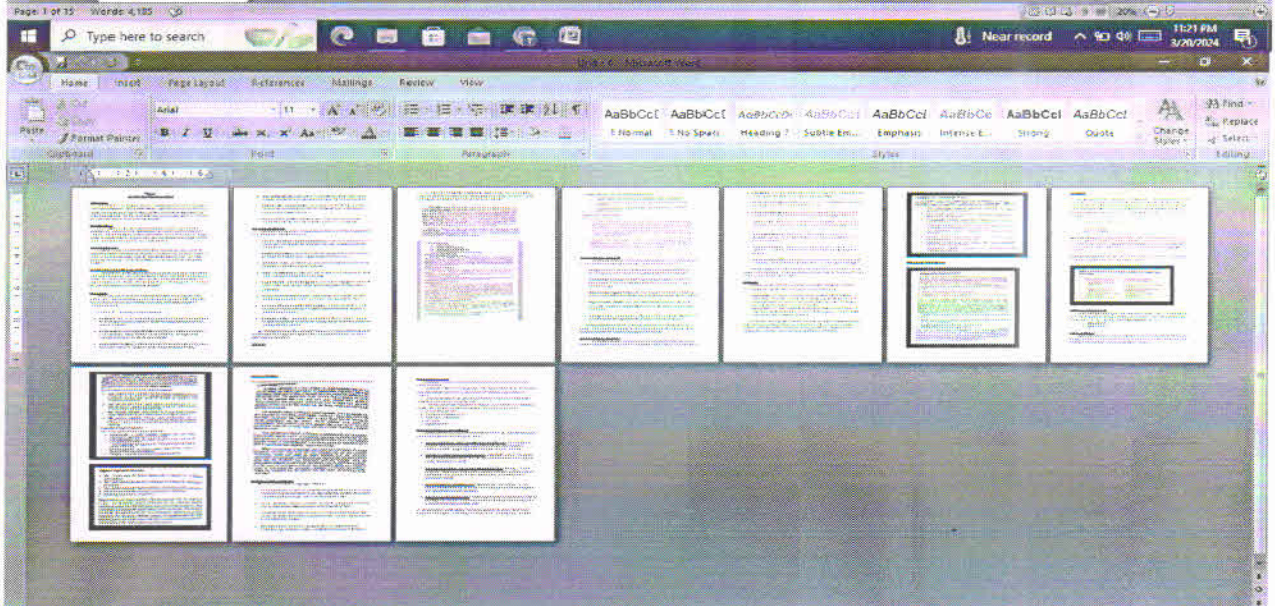
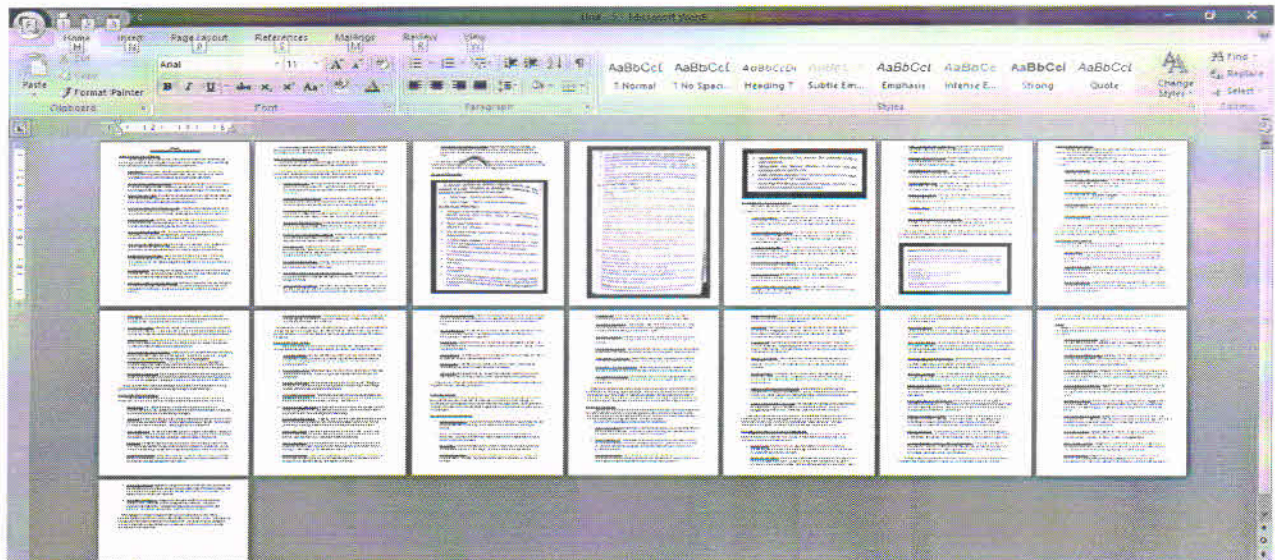

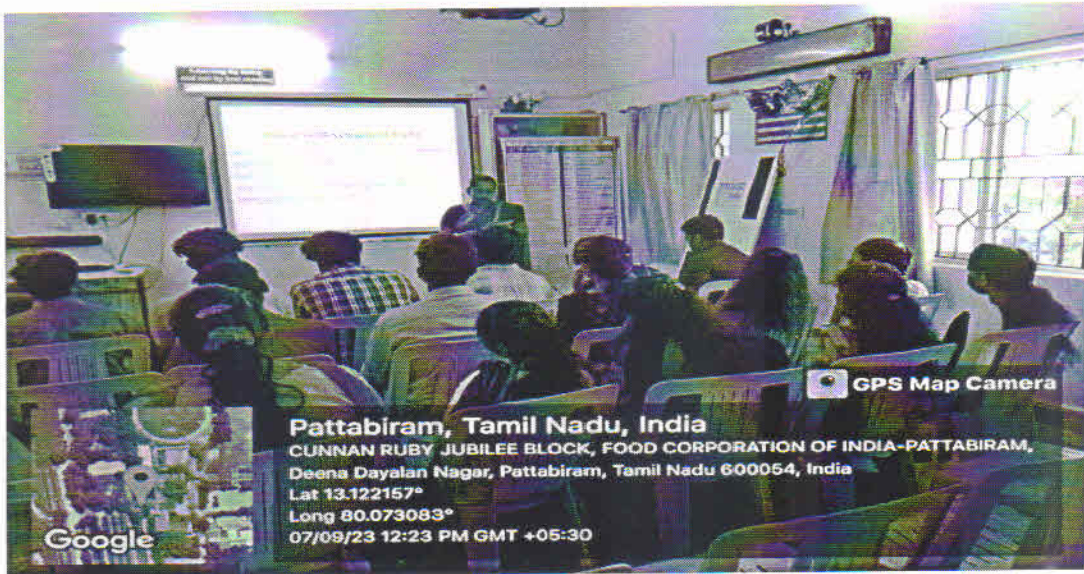

**Pattabiram, Tamil Nadu, India**  
CUNNAN RUBY JUBILEE BLOCK, FOOD CORPORATION OF INDIA-PATTABIRAM,  
Deena Dayalan Nagar, Pattabiram, Tamil Nadu 600054, India  
Lat 13.122157°  
Long 80.073083°  
07/09/23 12:23 PM GMT +05:30

Google



**Pattabiram, Tamil Nadu, India**  
CUNNAN RUBY JUBILEE BLOCK, FOOD CORPORATION OF INDIA-PATTABIRAM,  
Deena Dayalan Nagar, Pattabiram, Tamil Nadu 600054, India  
Lat 13.122157°  
Long 80.073083°  
07/09/23 12:23 PM GMT +05:30

Google



**Pattabiram, Tamil Nadu, India**  
CUNNAN RUBY JUBILEE BLOCK, FOOD CORPORATION OF INDIA-PATTABIRAM,  
Deena Dayalan Nagar, Pattabiram, Tamil Nadu 600054, India  
Lat 13.122185°  
Long 80.073132°  
12/09/23 05:02 PM GMT +05:30

Google

**1st B.COM ISM**  
50 students

**B.COM 2nd year ISM**  
91 students

**B.COM 3rd Year ISM**  
84 students

Teachers

Tejasveni

Students

- 23IS101Ajithkumar
- 23IS102 HARI
- 23IS103Harish
- 23IS107
- 23IS110 LOKESH.G

1st B.COM ISM

New material: Previous year question paper (November) 8:35 pm

New material: Previous year Question paper (April) 8:35 pm

New material: Unit 5 Accounting standards 8:16 pm

New material: Unit 4 - dissolution of Partnership firm 6:13 pm

Stream Classwork People

- Previous year question paper (N... Posted 8:35 pm
- Previous year Question paper (A... Posted 8:32 pm
- Unit 5 Accounting standards Posted 8:16 pm
- Unit 4 - dissolution of Partnershi... Posted 8:13 pm
- Unit 3 admission and retirement ... Posted 8:13 pm
- Unit 2 branch and departmental ... Posted 8:11 pm
- Unit 1 hire purchase and installm... Posted 8:10 pm
- Accounting standards Posted 13 Feb

Teachers

Tejasveni

Students

- Aathi shakthi 27
- Abinaya Moorthi
- Azar Ansari
- Chareeshma Sk
- Datchayani Gunaseelan

- Previous year Question paper Posted 8:22 pm
- Unit 5 Posted 8:05 pm
- Unit 1 Posted 8:05 pm
- Implementation of MIS in compa... Posted 13 Feb
- Exercise 10 - Prepare a financial ... Posted 23 Sep 2023
- Exercise 9 - Activation of interes... Posted 23 Sep 2023
- Exercise 8 - Activation of Tally in... Posted 23 Sep 2023
- Exercise 7 - Creation of payroll, ... Posted 23 Sep 2023

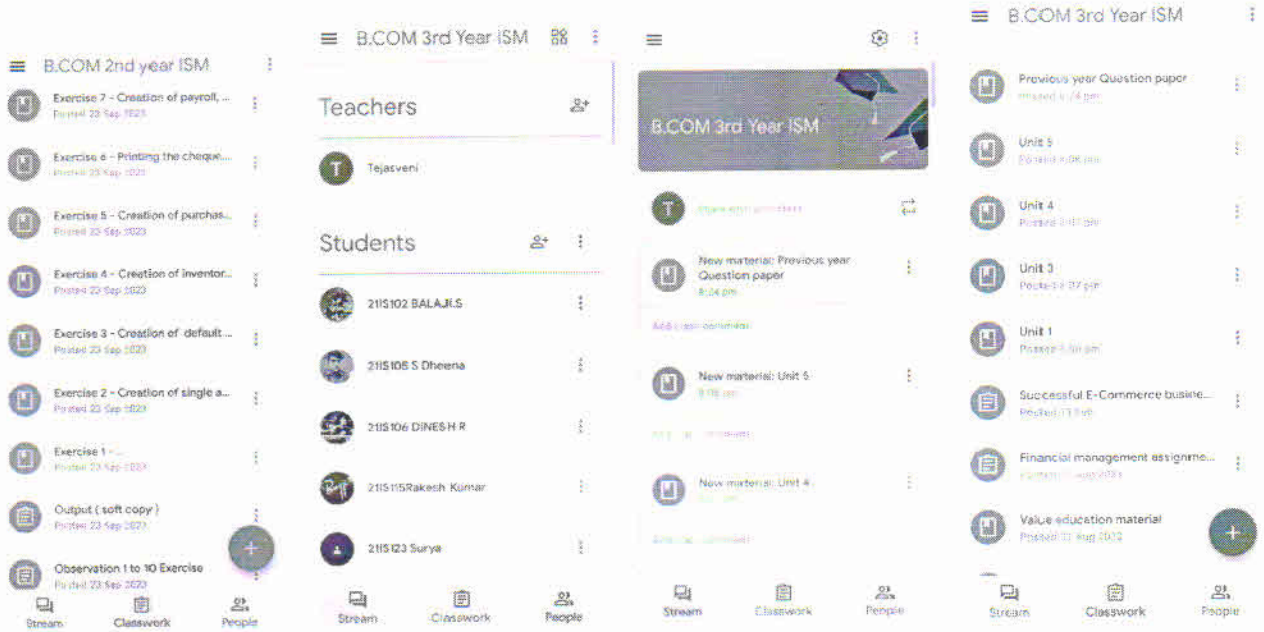

- **First year Google classroom link -**  
<https://classroom.google.com/c/NjI3ODQwOTY3NzQx?cjc=xn4zjs3>
- **Second yea Google classroom link -**  
<https://classroom.google.com/c/NjMzMzE1MDc2NzAw?cjc=r3c2rxi>
- **Third yea Google classroom link -**  
<https://classroom.google.com/c/NjE2NjM4MjI0MTMy?cjc=brs5xrj>



*G. Lakshminaray*  
 PRINCIPAL,  
 DHARMAMURTHI RADHAKRISHNAN ALAVALA CUNNAN  
 CHETTY S. HINDU COLLEGE,  
 DHARMAMURTHI NAGAR, PATTABIRAM,  
 CHENNAI - 600 072.

ICT tools



**Pattabiram, Tamil Nadu, India**  
SCIENCE BLOCK, FOOD CORPORATION OF INDIA-PATTABIRAM, Deena Dayalan Nagar,  
Pattabiram, Tamil Nadu 600054, India  
Lat 13.121847°  
Long 80.074155°  
19/03/24 05:26 PM GMT +05:30



*Indra*

Prof. Indhra M. Mandey MBA, M.Phil., M.Com.  
NET/MGT Head -  
Department of Business Administration (Shift 2)  
Dharmamurthi Rao Bahadur Calavala Cunnam  
Chetty's Hindu College,  
Pattabiram, Chennai - 600 072.

*G. Kalinmaray*  
PRINCIPAL,  
DHARMAMURTHI RAO BAHADUR GALAVALA CUNNAM  
CHETTY'S HINDU COLLEGE  
DHARMAMURTHI NAGAR, PATTABIRAM,  
CHENNAI - 600 072.

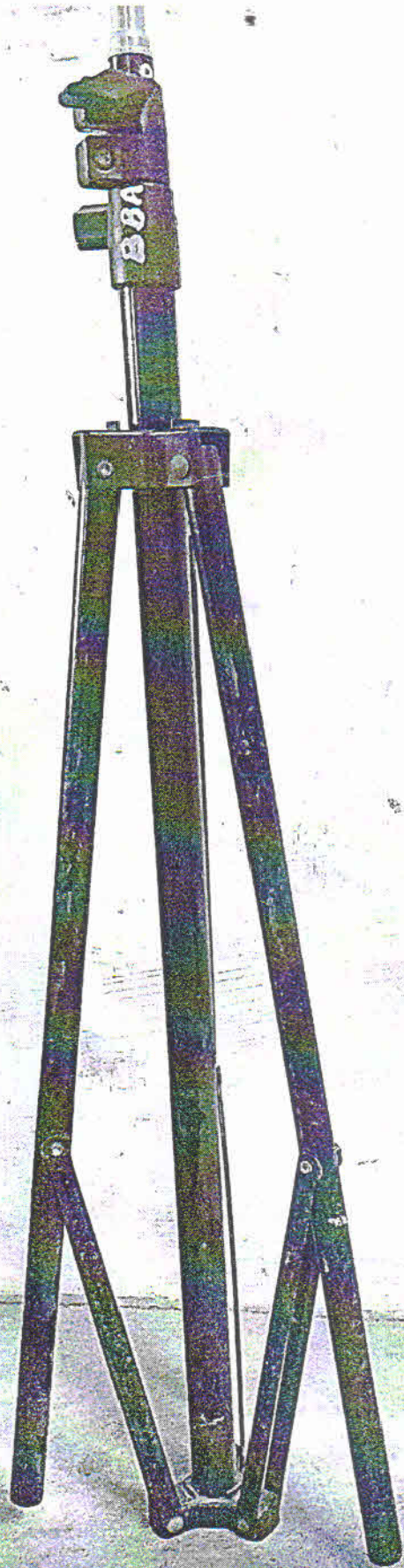

*G. valimuray*

PRINCIPAL,  
DHARMAMURTHI RAO BAHADUR CALAVALA CUNNAM  
CHETTY'S HINDU COLLEGE  
DHARMAMURTHI RAO PATTABIRAM,  
CHENNAI - 600 072.



 GPS Map Camera

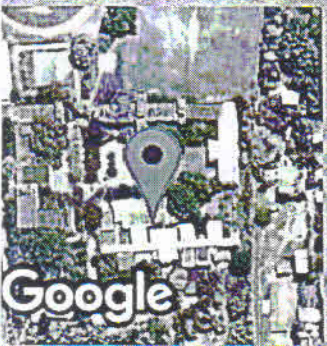

**Pattabiram, Tamil Nadu, India**

SCIENCE BLOCK, FOOD CORPORATION OF INDIA-PATTABIRAM, Deena

Dayalan Nagar, Pattabiram, Tamil Nadu 600054, India

Lat 13.121847°

Long 80.074155°

19/03/24 05:24 PM GMT +05:30

ICT Tools for Teaching

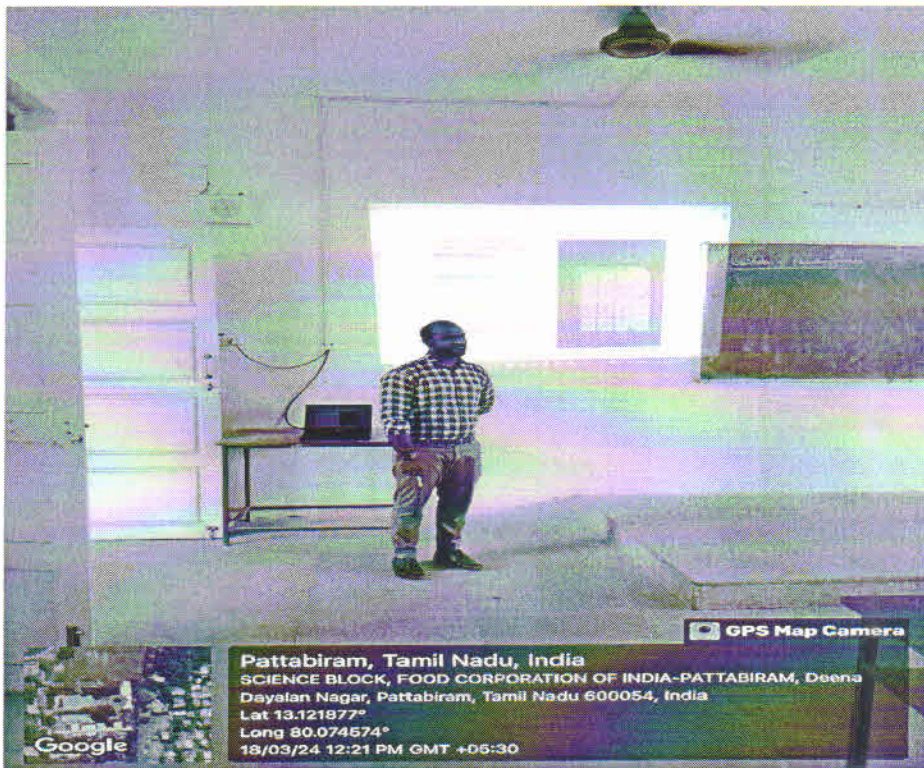

*G. Vasanthakumari*  
PRINCIPAL,  
DHARMAMURTHI RAO BAHADUR CALAYALA CUNNAM  
CHETTY'S HINDU COLLEGE  
DHARMAMURTHI NAGAR, PATTABIRAM,  
CHENNAI - 600 072.

*G. Jeyaraj*  
HEAD OF THE DEPARTMENT  
Department of Physics  
Dharmamurthi Rao Bahadur  
Calavala Cunnam Chetty's Hindu College (Shift 2)  
Dharmamurthi Nagar, Pattabiram, Chennai-72

2.3.2

9.3 a. - 2

# DEPARTMENT OF BCOM ISM

## ICT BASED TEACHING

**Dr. N. Preetha**

**Assistant Professor**

**2023-2024**

**ODD SEMESTER**

**Ist year and IInd year**

**Google Class Room**



*C. Chaitanya*  
PRINCIPAL,  
DHARMAMURTHI RAO RAJESHWAR CALAVALA CUNNAN  
CHETT  
DHARMA  
ADIRAM.  
Chennai - 600072.

## Teachers

0+

Preetha N

## Students

48 students

0+

- | <input type="checkbox"/> | Actions                 | AZ |
|--------------------------|-------------------------|----|
| <input type="checkbox"/> | A Kanimozhi             | ⋮  |
| <input type="checkbox"/> | Abitha Saritha          | ⋮  |
| <input type="checkbox"/> | Ajith Ajith             | ⋮  |
| <input type="checkbox"/> | Anu Priya               | ⋮  |
| <input type="checkbox"/> | CH. SABARISH            | ⋮  |
| <input type="checkbox"/> | Hari U                  | ⋮  |
| <input type="checkbox"/> | Harish                  | ⋮  |
| <input type="checkbox"/> | Hemachandran            | ⋮  |
| <input type="checkbox"/> | Jai Sakthi              | ⋮  |
| <input type="checkbox"/> | K.Raksith Roshan        | ⋮  |
| <input type="checkbox"/> | KarthickFF KarthickFF   | ⋮  |
| <input type="checkbox"/> | Keerthana               | ⋮  |
| <input type="checkbox"/> | Keerthana               | ⋮  |
| <input type="checkbox"/> | Keerthi Vasan           | ⋮  |
| <input type="checkbox"/> | Kevin W                 | ⋮  |
| <input type="checkbox"/> | Lingesh S               | ⋮  |
| <input type="checkbox"/> | Lokesh Shiva            | ⋮  |
| <input type="checkbox"/> | M. Vijay                | ⋮  |
| <input type="checkbox"/> | Manoj Sahadaven arjunan | ⋮  |
| <input type="checkbox"/> | Mathan Mylesh           | ⋮  |
| <input type="checkbox"/> | Meshak Meshak           | ⋮  |

Stream    Classwork    **People**    Grades

<input type="checkbox"/>		Monika . K	⋮
<input type="checkbox"/>		Monisha A	⋮
<input type="checkbox"/>		monisha krishnan	⋮
<input type="checkbox"/>		Nesa Kumar	⋮
<input type="checkbox"/>		Nikitha	⋮
<input type="checkbox"/>		Paul Raj	⋮
<input type="checkbox"/>		PURUSHOTHAMAN .R	⋮
<input type="checkbox"/>		R Raghul	⋮
<input type="checkbox"/>		Raju Nani	⋮
<input type="checkbox"/>		Robin Son	⋮
<input type="checkbox"/>		Rohith Rohith	⋮
<input type="checkbox"/>		Rubesh Raj Kumar	⋮
<input type="checkbox"/>		Saru Vignesh	⋮
<input type="checkbox"/>		SELF BELIEF VP	⋮
<input type="checkbox"/>		Shankar S	⋮
<input type="checkbox"/>		Shayam Ganesh	⋮
<input type="checkbox"/>		Shayini ramu	⋮
<input type="checkbox"/>		Shobana Sakthi	⋮
<input type="checkbox"/>		subalakshmi Subalakshmi	⋮
<input type="checkbox"/>		Surya Prakash	⋮
<input type="checkbox"/>		Usha Nandhini K	⋮
<input type="checkbox"/>		vignesh s	⋮
<input type="checkbox"/>		Vijaya raj	⋮
<input type="checkbox"/>		yegnesshwar venkatesan	⋮
<input type="checkbox"/>		Yogalakshmi Yogalakshmi	⋮
<input type="checkbox"/>		Yogesh Yogesh	⋮



Stream Classwork People Grades



Create

All topics

Skill Enhancement Lab

Posted Oct 6, 2023

Python Record Front Page

Posted Oct 6, 2023

Python Record typing work

Due Sep 25, 2023, 11:30 AM

Pandas Tutorial

Posted Sep 24, 2023

Python previous year question paper

Posted Sep 13, 2023

Unit 5 Assignment

Due Sep 20, 2023, 11:30 AM

Unit 4 Assignment

Due Sep 19, 2023, 11:30 AM

Python Record Programs

Posted Aug 23, 2023

Python Question Bank

Posted Aug 11, 2023

## Revision Test

15th nov revision Test

Due Nov 15, 2023, 5:30 PM

Today's revision test

Due Nov 24, 2023, 5:30 PM

Unit 4 Test

Due Nov 10, 2023, 2:30 PM

Unit 5 Revision Test

Unit 5 Test 10 mark and 5 mark

Help us improve this product!



No thanks

Show question

By continuing, you agree Google uses your answers, [account & system info](#) to improve services, per our [Privacy & Terms](#).

Stream Classwork People Grades

Python ppt

Python All 5 units material

Edited Sep 1, 2023

## PYTHON OBSERVATION

PYTHON PROGRAMS 7,8,9, 10

Edited Oct 4, 2023

Write next 3 programs 2

Due Jul 31, 2023, 1:45 PM

Python Record 5

Edited Jul 28, 2023

Observation first 3programs

Due Jul 17, 2023, 11:00 AM

## NME PRACTICAL

Students will see this topic once work is added to it

## Python observation and Record programs

Python observation

Edited Jul 28, 2023



Stream **Classwork** People Grades



Preetha N posted a new material: Skill Enhancement Lab  
Oct 6, 2023



Preetha N posted a new material: Python Record Front Page  
Oct 6, 2023



Preetha N posted a new assignment: Python Record typing work  
Sep 24, 2023 (Edited Sep 25, 2023)



Preetha N posted a new material: Pandas Tutorial  
Sep 24, 2023



Preetha N posted a new material: Python previous year question paper  
Sep 13, 2023



Preetha N posted a new assignment: Unit 5 Assignment  
Sep 13, 2023



Preetha N posted a new assignment: Unit 4 Assignment  
Sep 13, 2023 (Edited Sep 13, 2023)



 Nesa Kumar  
Sep 1, 2023

Finished this observation notes mam M.Nesa kumar



 python observation. pdf.pdf  
PDF

 Add class comment...



 Shankar S  
Aug 28, 2023

I am finished my Python observation mam



 shankar observation\_compressed.pdf  
PDF

 Add class comment...



Customize

# I YEAR PYTHON

Announce something to your class

Preetha N posted a new assignment: Today's revision test  
Nov 24, 2023

Preetha N posted a new assignment: 15th nov revision Test  
Nov 15, 2023 (Edited Nov 24, 2023)

monisha krishnan  
Nov 15, 2023

Monisha

K.Monisha.pdf  
PDF

Add class comment...

Preetha N posted a new assignment: Unit 4 Test  
Nov 10, 2023

monisha krishnan  
Nov 10, 2023

Monisha.k

Monisha.K.pdf  
PDF

Add class comment...

Preetha N posted a new assignment: Unit 5 Revision Test

Help us improve this product!

No thanks Show question

By continuing, you agree Google uses your answers, account & system info to improve services, per our [Privacy & Terms](#).

People Grades

Settings icon, Help icon

Sort by last name

Nov 24, 20... Today's revision

Nov 15, 20... 15th nov revision

Nov 10, 20... Unit 4 Test

Nov 9, 2023 Unit 5 Revision

Nov 8, 2023 Unit 5 Test 10 mark

Sep 25, 20... Python Record

Sep 20, 20... Unit 5 Assignme out of 5

Sep 19, 20... Unit 4 Assignme out of 5

Class Average	N/A	N/A	N/A	N/A	N/A	N/A	3.95	4.47
A Kanmozhi	Turned in Done late	Turned in	Turned in	Turned in	Turned in	Turned in	5	5
A Abitha Saritha	Missing	Missing	Turned in	Turned in	Turned in Done late	Turned in	5	5
A Ajith Ajith	Missing	Missing	Missing	Missing	Turned in Done late	Missing	3 Done late	4 Done late
Anu Priya	Turned in	Turned in	Turned in	Turned in	Turned in Done late	Missing	5	5
CH. SABARISH	Turned in Done late	Turned in Done late	Turned in Done late	Turned in Done late	Turned in Done late	Turned in	5 Done late	5
Harl U	Missing	Missing	Missing	Missing	Missing	Missing	3 Done late	4 Done late
Harish	Turned in	Turned in	Turned in Done late	Turned in	Turned in Done late	Turned in	3 Done late	5
Hemachandran	Turned in Done late	Missing	Turned in	Turned in Done late	Turned in Done late	Missing	3 Done late	5
Jai Sakthi	Turned in	Turned in	Turned in	Turned in	Turned in Done late	Turned in	Missing	Missing
K.Raksith Roshan	Missing	Turned in Done late	Turned in Done late	Turned in Done late	Missing	Turned in Done late	3 Done late	5
K KarthickFF KarthickFF	Missing	Missing	Missing	Missing	Missing	Missing	3 Done late	4 Done late
Keerthana	Missing	Turned in	Turned in	Turned in	Turned in Done late	Turned in	3 Done late	4 Done late
Keerthana	Turned in	Turned in	Turned in	Turned in	Turned in	Turned in	5	5
Keerthi Vasan	Missing	Turned in Done late	Turned in	Turned in Done late	Turned in Done late	Missing	Missing	Missing
Kevin W	Missing	Missing	Missing	Missing	Missing	Missing	Missing	Missing
L Lingesh S	Turned in Done late	Turned in	Turned in	Missing	Turned in	Turned in	5	Missing
L Lokesh Shiva	Missing	Missing	Missing	Missing	Missing	Missing	5/5 Draft	5
M. Vijay	Missing	Missing	Missing	Turned in	Turned in Done late	Missing	3 Done late	Missing
M Manoj Sahadaven arjunan	Turned in Done late	Turned in Done late	Turned in	Turned in Done late	Turned in	Missing	3 Done late	4 Done late
Mathan Mylesh	Missing	Missing	Missing	Missing	Missing	Missing	Missing	Missing
Meshak Meshak	Missing	Missing	Turned in Done late	Turned in	Turned in Done late	Missing	5/5 Done late	5/5 Done late
M Mohammed Yusuf	Missing	Missing	Missing	Turned in	Turned in	Missing	3 Done late	5
Monika . K	Turned in Done late	Turned in	Turned in	Turned in	Turned in	Turned in	5	4
Monisha A	Turned in Done late	Turned in Done late	Turned in	Turned in Done late	Turned in Done late	Turned in	5	4 Done late?

Stream	Classwork	People	Grades						
m	monisha krishnan	Missing	Turned in	Missing	Missing	Missing	Missing	Missing	Missing
	Nesa Kumar	Missing	Missing	Missing	Missing	Missing	Missing	4 Done late	5
N	Nikitha	Turned in Done late	Turned in	Turned in	Turned in	Turned in Done late	Turned in	5	5 Draft
	Paul Raj	Missing	Turned in Done late	Missing	Missing	Missing	Turned in	Missing	Missing
P	PURUSHOTHAMAN .R	Missing	Missing	Missing	Turned in	Turned in	Missing	3 Done late	4 Done late
	R Raghul	Missing	Missing	Missing	Turned in	Turned in	Missing	5	5
R	Raju Nani	Missing	Missing	Turned in	Turned in Done late	Turned in Done late	Turned in Done late	3 Done late	3 Done late
	Robin Son	Missing	Missing	Missing	Missing	Missing	Missing	3 Done late	4 Done late
R	Rohith Rohith	Missing	Missing	Missing	Missing	Missing	Missing	4 Done late	5
R	Rubesh Raj Kumar	Missing	Turned in	Turned in	Turned in	Turned in Done late	Turned in	5	5
S	Saru Vignesh	Turned in Done late	Missing	Missing	Turned in Done late	Turned in Done late	Missing	Missing	Missing
	SELF BELIEF VP	Turned in	Turned in	Turned in	Turned in	Turned in	Turned in	4 Done late	5
S	Shankar S	Turned in	Turned in	Turned in	Turned in	Turned in	Missing	5	5
	Shayam Ganesh	Missing	Turned in	Turned in Done late	Missing	Turned in Done late	Turned in	3 Done late	4
S	Shayini ramu	Turned in	Turned in	Turned in	Turned in	Turned in	Turned in	5	5
S	Shobana Sakthi	Turned in Done late	Turned in	Turned in	Turned in	Turned in	Missing	5	Missing
	subalakshmi Subalakshmi	Turned in	Turned in	Turned in	Turned in	Turned in Done late	Turned in	3 Done late	5 Draft
S	Surya Prakash	Missing	Missing	Missing	Missing	Missing	Missing	3 Done late	5 Draft
U	Usha Nandhini K	Turned in	Missing	Turned in	Turned in	Turned in Done late	Missing	5	Missing
V	vignesh s	Missing	Missing	Missing	Missing	Missing	Missing	3 Done late	4 Done late
X	Vijaya raj	Turned in	Turned in	Turned in	Turned in Done late	Turned in Done late	Turned in	5	5
	yegnesswar venkatesan	Turned in Done late	Turned in	Turned in	Turned in	Turned in Done late	Turned in	5 Done late	4 Done late
Y	Yogalakshmi Yogalakshmi	Turned in	Turned in	Turned in	Turned in	Turned in Done late	Missing	3 Done late	4 Done late
Y	Yogesh Yogesh	Missing	Missing	Missing	Missing	Missing	Missing	Missing	4 Done late

## Teachers



**P** Preetha N

## Students

50 students



Actions



Aathi shakthi 27



Abinaya Moorthi



Azar Ansari



Chareeshma Sk



Datchayani Gunaseelan



Deepak . T



Deepak ram.r



Deepika S



Dhana Lakshmi



Divya



Ganesh Ganesh



Hari Haran.V



Hari Priya .G



Hassan Farook



Iluckya K



Indumathi



Jananee Udaya



JITHESH \_ SRINATH



Jothishwaran Jothishwaran



Kamalesh Borana





























Kanmani Kanmani



Karpagam



Stream Classwork People Grades

-  Mohan 77 ⋮
-  N.deepika Nagarajan ⋮
-  Naveen Kumar Naveen ⋮
-  Nithyababu ⋮
-  Pandeewaran Pandi ⋮
-  Pooja S ⋮
-  Priya Dharshini ⋮
-  Punitha Gobi ⋮
-  RakeshRakesh S ⋮
-  Ranjani RR ⋮
-  rohith Kumar ⋮
-  Samuvel Kamal ⋮
-  Sandhya Devi ⋮
-  Sangeetha Sangeetha ⋮
-  shalini 13 ⋮
-  Shalini Sangee ⋮
-  Sneka T G ⋮
-  Solai raja Shanmugakani ⋮
-  sudharsan kumar ⋮
-  Swasanthosh3105 ⋮
-  Tamil Kalai ⋮
-  Tilip Kumar ⋮
-  Vaishnavi .k ⋮
-  Venkat Krish ⋮
-  Vinoth Kumar ⋮
-  Vnaveen Kumar ⋮
-  m dheepak ⋮

Create

All topics

Unit 4 revision test Due Nov 9, 2023, 1:30 PM

Stream Classes in Java 1 Due Sep 15, 2023, 11:30 AM

Java Question and Answer Posted Aug 11, 2023

Copy Constructor and Method Overloading Due Jul 31, 2023, 11:50 AM

## Revision Test

Unit 3 revision Test Due Nov 15, 2023, 5:30 PM

Unit 3 revision Test Due Nov 10, 2023, 2:30 PM

Unit 5 Test 10 mark and 5 mark Due Nov 8, 2023, 12:05 PM

## Control Structures

Control Structures Due Jul 17, 2023, 10:30 AM

## Java Lab Manual

Java Lab Manual Posted Jul 13, 2023

## JAVA NOTES

Java Exception Handling Posted Aug 26, 2023

Java Packages and API Posted Aug 23, 2023

Java Thread, Lifecycle, Multithreading, thre... Posted Aug 23, 2023

Java Arrays and string Posted Aug 17, 2023

Java 5 Units Notes Posted Jul 28, 2023

Java Notes Posted Jul 11, 2023

Customize

# IIND YEAR JAVA



Announce something to your class



Preetha N posted a new assignment: Unit 3 revision Test  
Nov 15, 2023



Preetha N posted a new assignment: Unit 3 revision Test  
Nov 10, 2023 (Edited Nov 15, 2023)



Preetha N posted a new assignment: Unit 4 revision test  
Nov 9, 2023



Preetha N posted a new assignment: Unit 5 Test 10 mark and 5 mark  
Nov 7, 2023 (Edited Nov 7, 2023)



Ranjani RR  
Sep 15, 2023



P.Ranjani



(stream class) java.pdf  
PDF



Add class comment...



Deepak . T  
Sep 15, 2023



T.Deepak



stream class.java.pdf  
PDF



Add class comment...



Pandeewaran Pandi  
Sep 15, 2023



A.pandeewaran



A. pandeewaran (1).pdf  
PDF

Stream   Classwork   People   Grades

 Sandhya Devi  
Sep 15, 2023



N.Sandhya devi

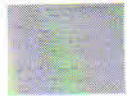

DocScanner 14 Sept 2023 8-28 pm.pdf  
PDF



Add class comment...



 Kamalesh Borana  
Sep 15, 2023



J.kamalesh Borana



Stream class.pdf  
PDF



Add class comment...



 Deepak ram.r  
Sep 14, 2023



Deepak Ram.R



























(stream class) Deepak Ram.R.pdf  
PDF



Add class comment...



Stream    Classwork    People    Grades

 Class average	N/A	N/A	N/A	N/A	4.63	4.79	4.48
 Aathi shakthi 27	Turned in	Turned in Done late	Turned in Done late	Turned in Done late	4 Done late	4 Not turned in	5
 Ablaya Moorthi	Turned in Done late	Turned in Done late	Turned in Done late	Turned in Done late	Missing	Missing	4
 Azar Ansari	Turned in	Missing	Missing	Missing	5	Missing	3 Done late
 Chareeshma Sk	Turned in Done late	Turned in	Turned in	Missing	5	Missing	5
 Datchayani Gunaseelan	Missing	Turned in	Turned in	Turned in	5	Missing	Missing
 Deepak . T	Missing	Turned in	Turned in	Turned in	5 Resubmitted	___/5 Done late	Missing
 Deepak ram.r	Turned in	Turned in	Turned in	Turned in Done late	5	___/5 Done late	Missing
 Deepika S	Turned in	Turned in	Turned in	Turned in	5	___/5 Done late	Missing
 Dhana Lakshmi	Turned in	Turned in	Turned in	Turned in	4 Done late	Missing	5
 Divya	Turned in Done late	Turned in	Turned in	Turned in	5	5	Missing
 Ganesh Ganesh	Missing	Turned in Done late	Turned in Done late	Turned in Done late	Missing	4 Done late	Missing
 Hari Haran.V	Turned in	Turned in	Turned in	Turned in	5	5	5
 Hari Priya .G	Turned in	Turned in	Turned in Done late	Turned in	4 Done late	Missing	Missing
 Hassan Farook	Turned in Done late	Turned in	Turned in	Turned in	5	5 Resubmitted	Missing
 Iluckya K	Turned in Done late	Turned in Done late	Turned in	Turned in Done late	___/5 Draft	Missing	Missing
 Indumathi	Turned in	Turned in	Turned in	Turned in Done late	5	Missing	Missing
 Jananee Udaya	Turned in	Turned in	Turned in	Turned in	5	5	5
 JITHESH _SRINATH	Missing	Turned in	Turned in	Turned in	5	___/5 Done late	5
 Jothishwaran Jothishwaran	Missing	Missing	Missing	Missing	Missing	Missing	Missing
 Kamalesh Borana	Missing	Turned in	Turned in	Turned in Done late	5 Draft	Missing	4 Done late
 Kanmani Kanmani	Turned in	Turned in	Turned in	Turned in	5 Draft	Missing	Missing
 Karpagam	Turned in Done late	Missing	Turned in Done late	Turned in Done late	5	Missing	Missing
 Manoj Kumar. J	Missing	Missing	Missing	Missing	5	Missing	Missing
 Mohan 77	Missing	Turned in	Turned in	Missing	Missing	Missing	Missing

Stream: Classwork People Grades

Stream	Classwork	People	Grades	Grades	Grades	Grades	Grades	Grades
N.deepika Nagarajan	Turned in	Turned in	Missing	Turned in Done late	5	.../5 Done late	Missing	Missing
Naveen Kumar Naveen	Missing	Missing	Missing	Missing	4 Done late	4 Done late	3 Done late	3 Done late
Nithyababu	Turned in	Turned in	Turned in	Turned in	5	5	5	5
Pandeeswaran Pandi	Turned in	Turned in	Turned in	Turned in	3 Draft	Missing	Missing	Missing
Pooja S	Turned in	Turned in	Missing	Turned in	4 Done late	Missing	5	5
Priya Dharshini	Turned in	Turned in	Turned in	Turned in	4 Done late	.../5 Done late	5	5
Punitha Gobi	Turned in	Turned in	Turned in	Turned in	5	Missing	Missing	Missing
RakeshRakesh S	Missing	Missing	Missing	Missing	3 Done late	Missing	5	5
Ranjani RR	Missing	Turned in	Missing	Turned in Done late	4 Done late	Missing	Missing	Missing
rohith Kumar	Turned in	Turned in	Turned in	Turned in Done late	5	5	4	4
Samuvel Kamal	Turned in	Turned in Done late	Turned in	Turned in	4 Done late	Missing	Missing	Missing
Sandhya Devi	Turned in	Turned in	Turned in	Turned in Done late	5	.../5 Done late	Missing	Missing
Sangeetha Sangeetha	Turned in	Turned in	Turned in	Turned in Done late	5	Missing	Missing	Missing
shalini 13	Turned in	Turned in	Turned in	Turned in Done late	5	5	4	4
Shalini Sangee	Turned in	Turned in	Turned in	Turned in	4 Done late	.../5 Done late	Missing	Missing
Sneha G	Turned in Done late	Turned in Done late	Turned in Done late	Turned in	5	Missing	5	5
Solai raja Shanmugakani	Turned in	Turned in	Turned in	Turned in	5	5	5	5
sudharsan kumar	Missing	Missing	Missing	Missing	5	Missing	4	4
Swasanthosh3105	Turned in	Turned in	Missing	Missing	4 Not turned in	Missing	5	5
Tamil Kalai	Missing	Missing	Missing	Missing	Missing	Missing	Missing	Missing
Tilip Kumar	Missing	Turned in Done late	Turned in	Turned in Done late	Missing	Missing	Missing	Missing
Vaishnavi .k	Turned in	Turned in	Turned in	Turned in	5	5	3 Done late	3 Done late
Venkat Krish	Missing	Missing	Missing	Missing	Missing	Missing	Missing	Missing
Vinoth Kumar	Missing	Turned in Done late	Turned in	Missing	5	Missing	4	4
Vnaveen Kumar	Missing	Missing	Missing	Missing	4 Done late	5	Missing	Missing
m dheepak	Turned in	Turned in	Turned in	Turned in	5	5	5	5



*G. Srinivasan*  
 PRINCIPAL,  
 DHARMAMURTHI RAO BAHADUR DALAVALA CUNNAM  
 CHETTY'S HINDU COLLEGE  
 DHARMAMURTHI RAO BAHADUR DALAVALA  
 CHENNAI - 600 012.

4. b) Equipments

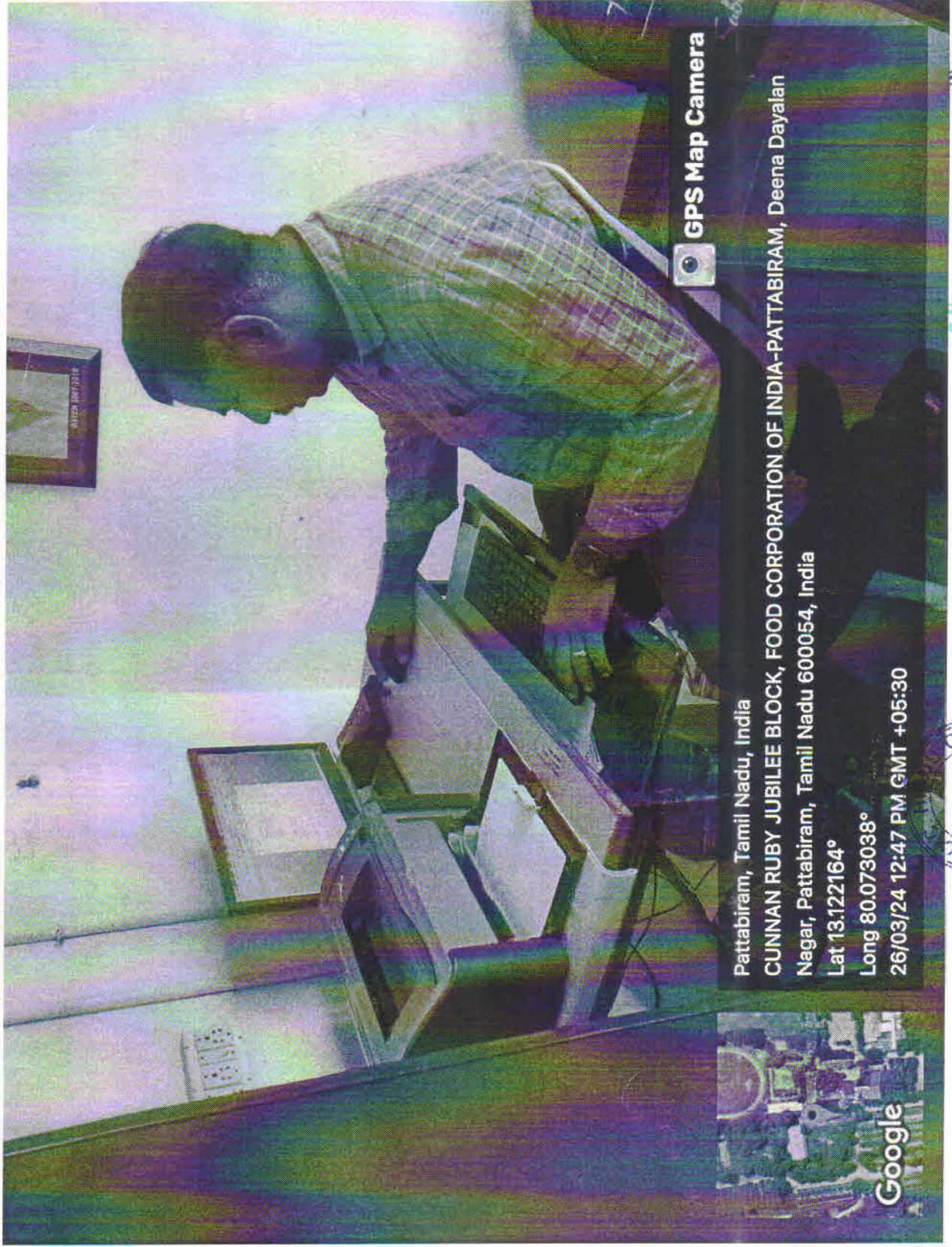

GPS Map Camera

Pattabiram, Tamil Nadu, India  
CUNNAN RUBY JUBILEE BLOCK, FOOD CORPORATION OF INDIA-PATTABIRAM, Deena Dayalan  
Nagar, Pattabiram, Tamil Nadu 600054, India  
Lat 13.122164°  
Long 80.073038°  
26/03/24 12:47 PM GMT +05:30

Google

*Handwritten signature and date: 26/3/24*

*C. Kalinmozhi*  
PRINCIPAL,  
REGALAVALA CUNNAN  
COLLEGE  
DHARMAMURTHI PAC  
CHETTY  
PATTABIRAM  
TAMIL NADU - 600054



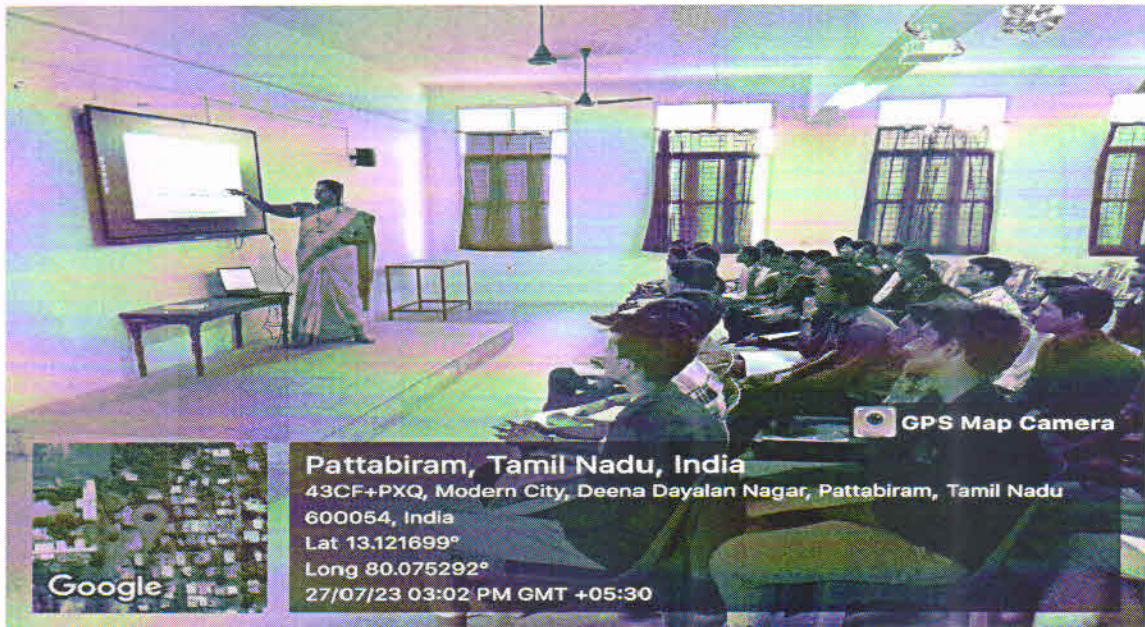

**Pattabiram, Tamil Nadu, India**  
 43CF+PXQ, Modern City, Deena Dayalan Nagar, Pattabiram, Tamil Nadu  
 600054, India  
 Lat 13.121699°  
 Long 80.075292°  
 27/07/23 03:02 PM GMT +05:30

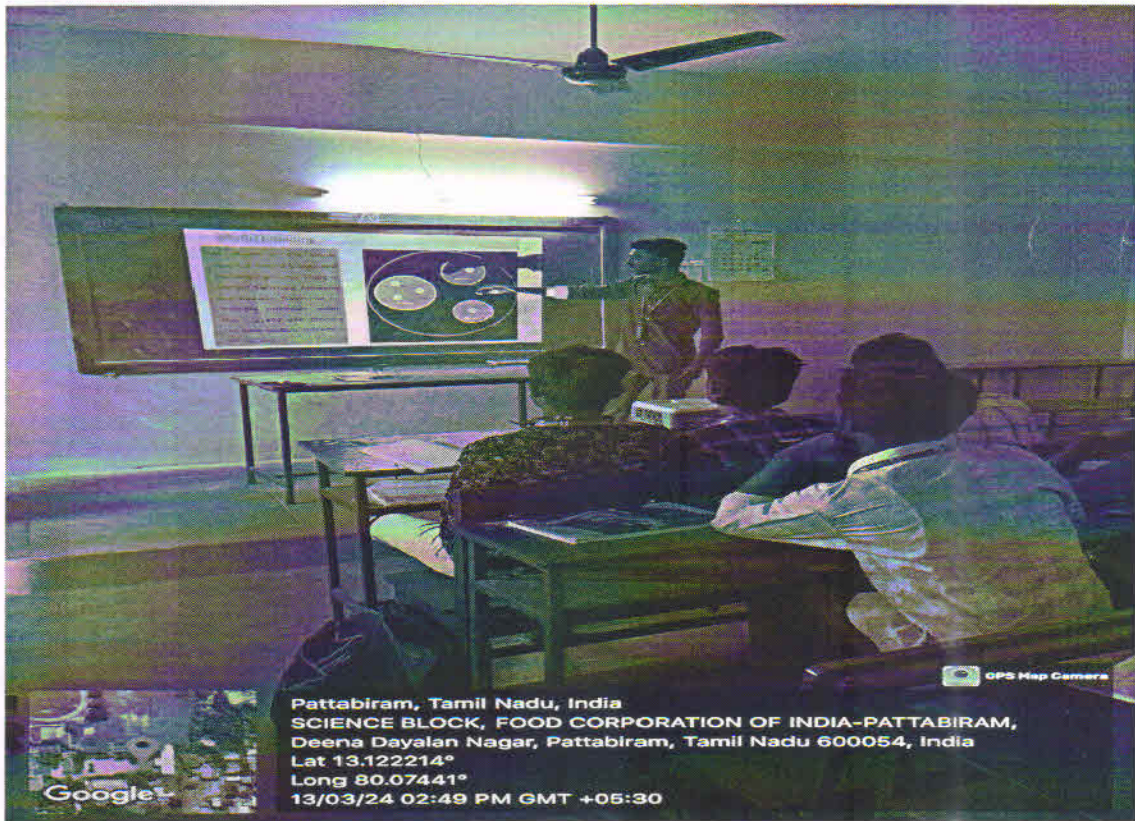

**Pattabiram, Tamil Nadu, India**  
 SCIENCE BLOCK, FOOD CORPORATION OF INDIA-PATTABIRAM,  
 Deena Dayalan Nagar, Pattabiram, Tamil Nadu 600054, India  
 Lat 13.122214°  
 Long 80.07441°  
 13/03/24 02:49 PM GMT +05:30

*Dra. Sriswathi*  
 Dharmamurthi Rao Bahadur  
 Jalavala Cunnan Chetty's Hindu College (Shift :  
 Dharmamurthi Nagar,  
 Pattabiram, Chennai-600072.

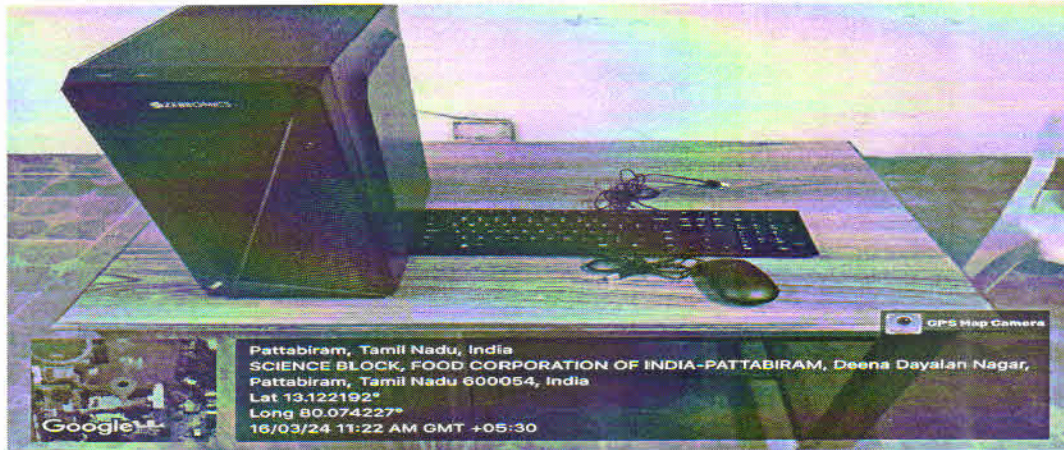

*Dr. U. Sri Senthil*  
Dharmamurthi Rao Bahaour  
Calavala Cunnan Chetty's Hindu College (Shri...  
Dharmamurthi Nagar,  
Pattabiram, Chennai-600072.

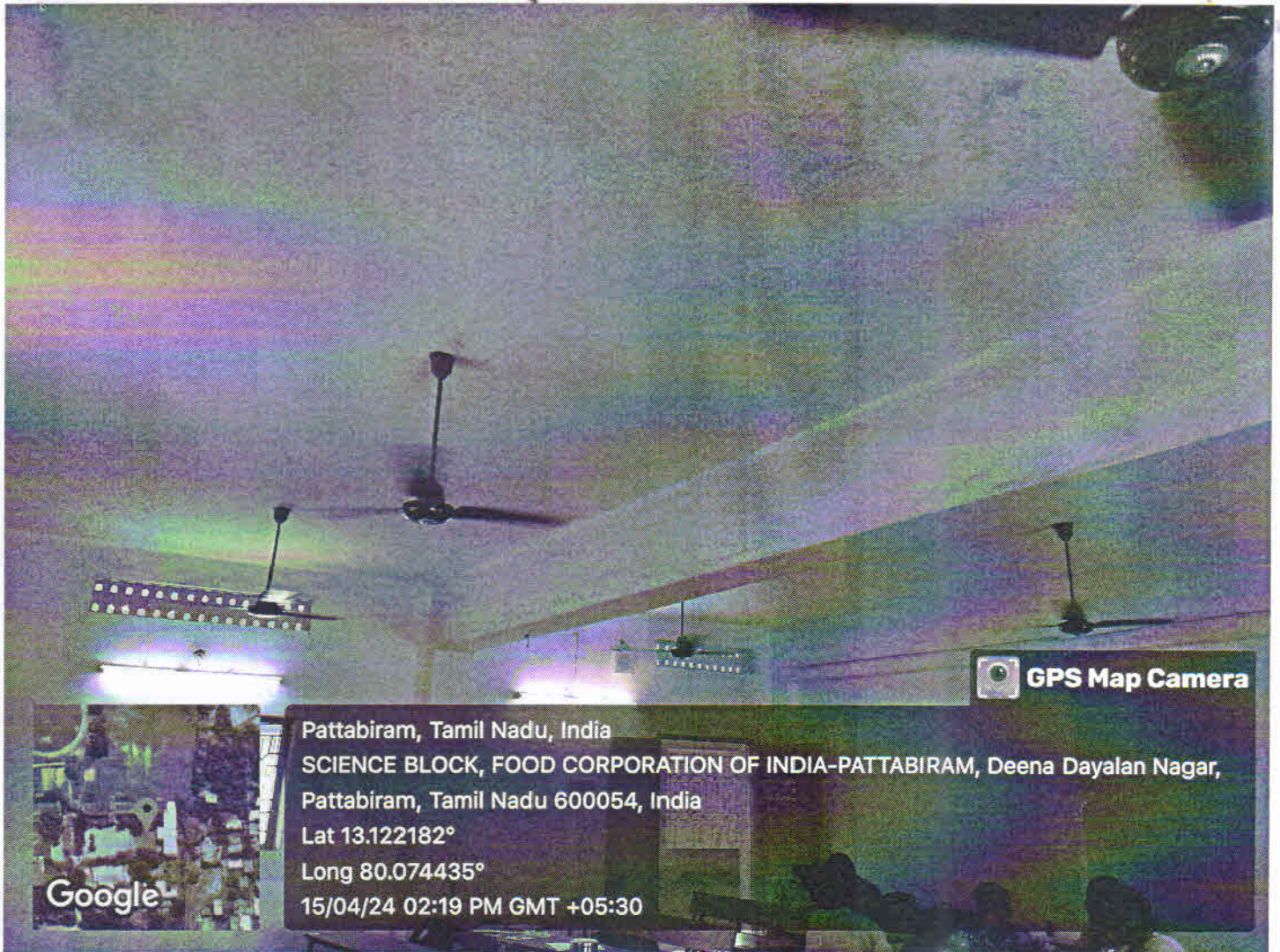

 **GPS Map Camera**

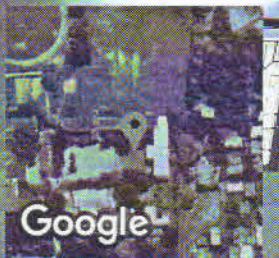

Pattabiram, Tamil Nadu, India  
 SCIENCE BLOCK, FOOD CORPORATION OF INDIA-PATTABIRAM, Deena Dayalan Nagar,  
 Pattabiram, Tamil Nadu 600054, India  
 Lat 13.122182°  
 Long 80.074435°  
 15/04/24 02:19 PM GMT +05:30

*Dr. U. Sai Sathish*

Dharmamurthi Rao Bahadur  
 Calavala Chettiar Chetty's Hindu College (Shri)  
 Dharmamurthi Nagar,  
 Pattabiram, Chennai-600072



*G. Lakshminaray*

**PRINCIPAL,**  
 DHARMAMURTHI RAO BAHADUR CALAVALA CUNNAM  
 CHETTY'S HINDU COLLEGE  
 DHARMAMURTHI NAGAR, PATTABIRAM,  
 CHENNAI - 600 072.

2.3.2

### ICT enabled Classes

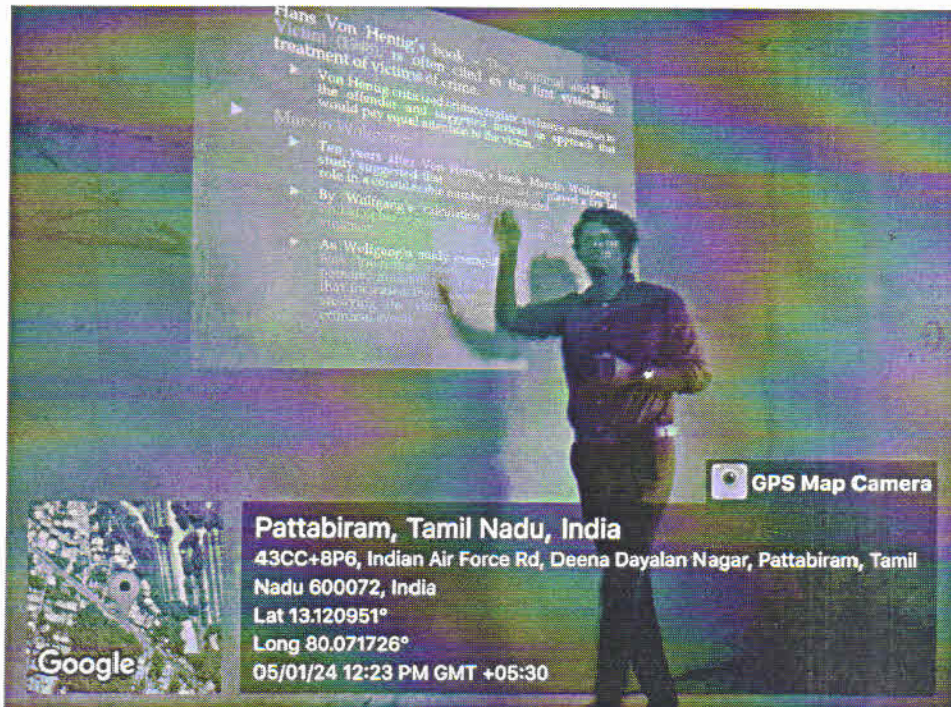
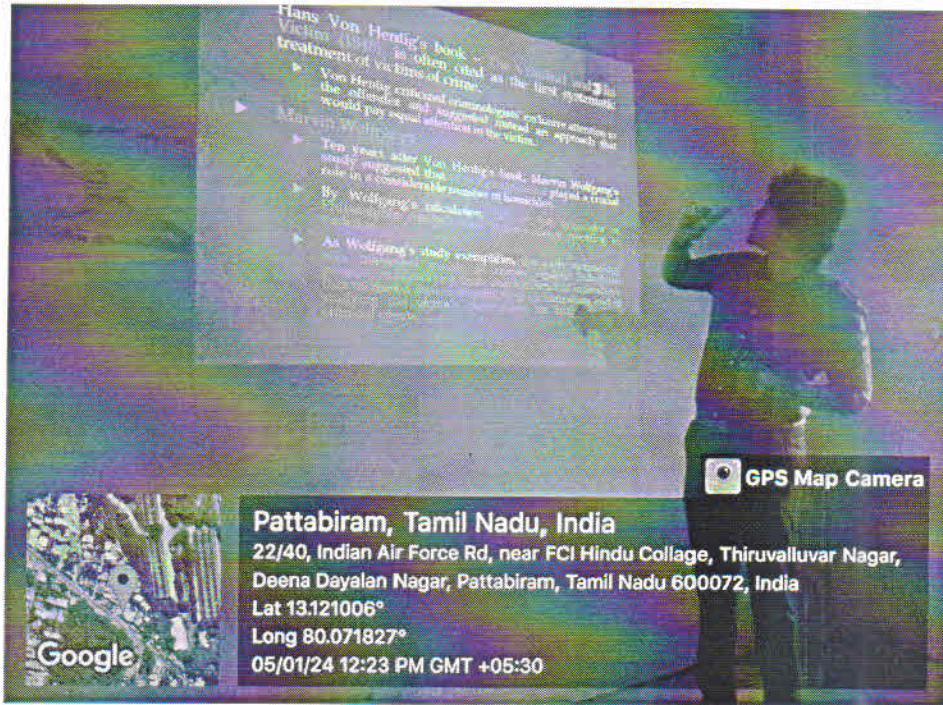

*G. Narayanasamy*  
 PRINCIPAL,  
 DHARMAMURTHI RAO BAHADUR GALAVALA GUNNAM  
 CHETTY HINDU COLLEGE  
 PATTABIRAM, CHENNAI - 72

*E. Jambhaji*  
 DEPARTMENT OF CRIMINOLOGY  
 AND POLICE ADMINISTRATION  
 DRBCCC HINDU COLLEGE  
 PATTABIRAM, CHENNAI - 72.

C. Kay  
Pharmacist  
Chennai-600008

GPS Map Camera

19/03/24 01:34 PM

Action	Student Name	Unit Number	Registration Number	Mobile Number	Gen
17	CHEN YI YI	PH0020214	100000000	980000000	100
17	CHEN YI YI	PH0020214	100000000	980000000	100
17	CHEN YI YI	PH0020214	100000000	980000000	100
17	CHEN YI YI	PH0020214	100000000	980000000	100
17	CHEN YI YI	PH0020214	100000000	980000000	100





Dharm  
Kathavala  
Patil  
K. S. Bahadur  
Hindu College (Shift 2)  
Shri Nagar,  
Mumbai-500072

*Prof. C*

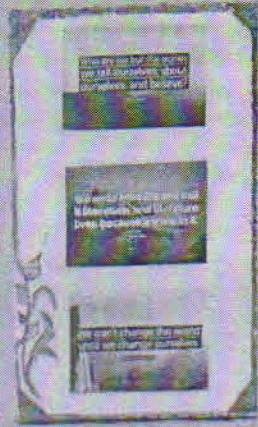

SEMESTER

SEMESTER

CONTEMPORARY LITERATURE

POST COLONIAL LITERATURE IN ENGLISH

INDIAN LITERATURE IN ENGLISH

GREEN STUDIES

WOMEN'S WRITING

EXTENSION ACTIVITIES

Sl. No.	Topic	Time	Room
1	32	58	52

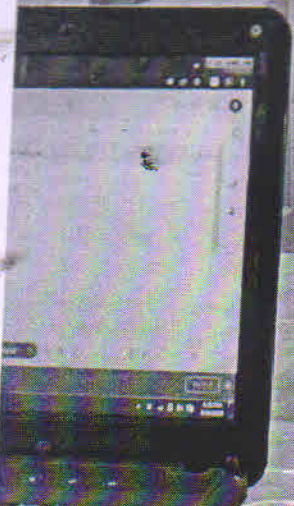
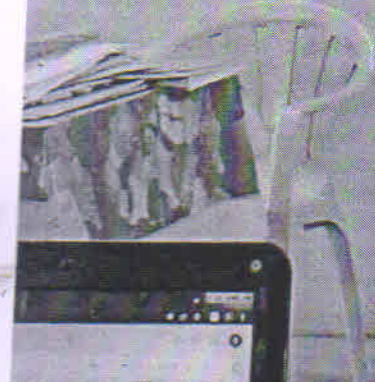
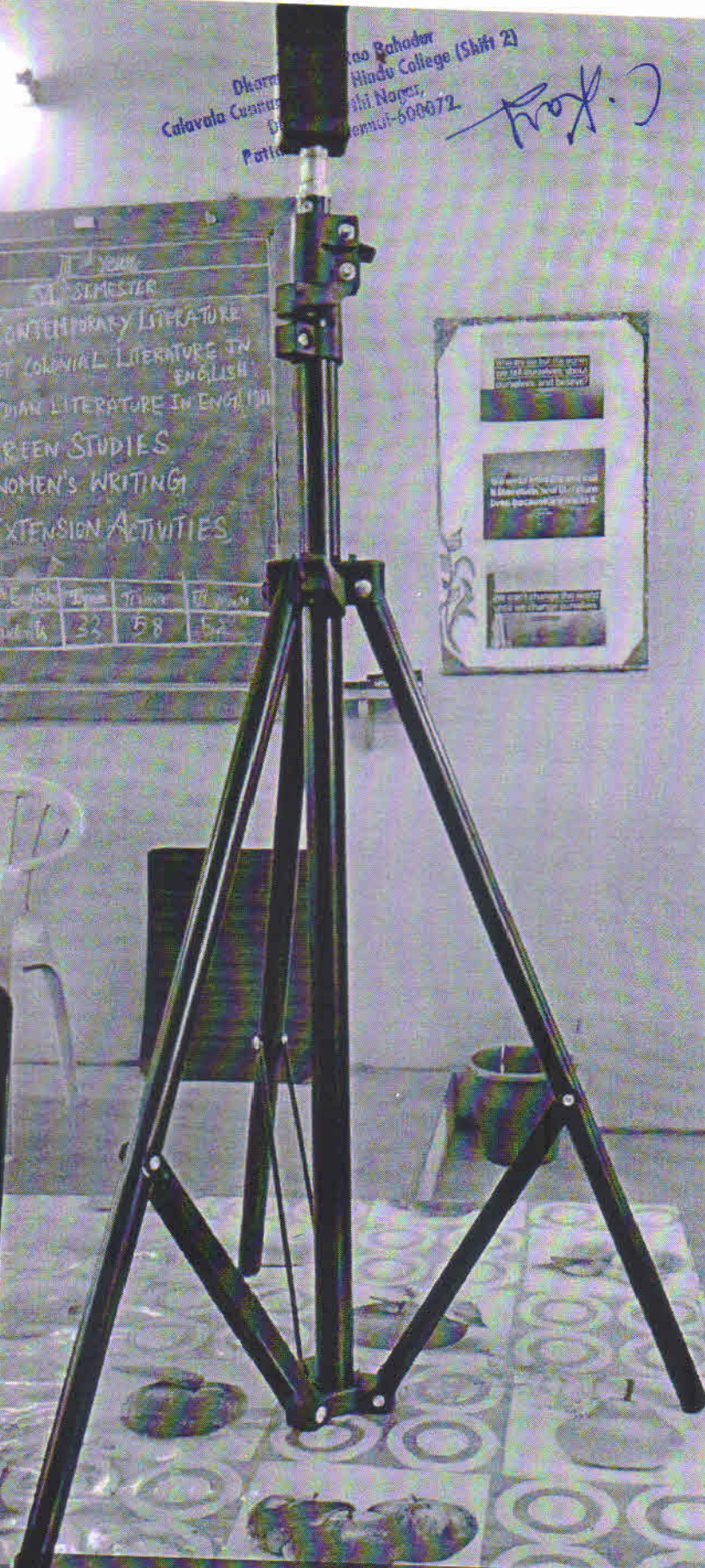

19/03/24 01:28 PM

GPS Map Camera

Google

Equipments



GPS Map Camera

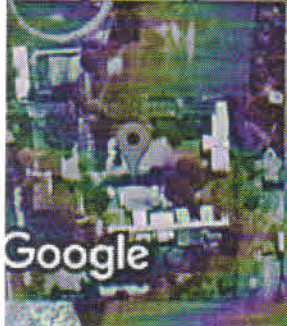

Pattabiram, Tamil Nadu, India  
SCIENCE BLOCK, FOOD CORPORATION OF INDIA-PATTABIRAM, Deena Dayalan  
Nagar, Pattabiram, Tamil Nadu 600054, India  
Lat 13.121958°  
Long 80.073989°  
14/03/24 12:53 PM GMT +05:30

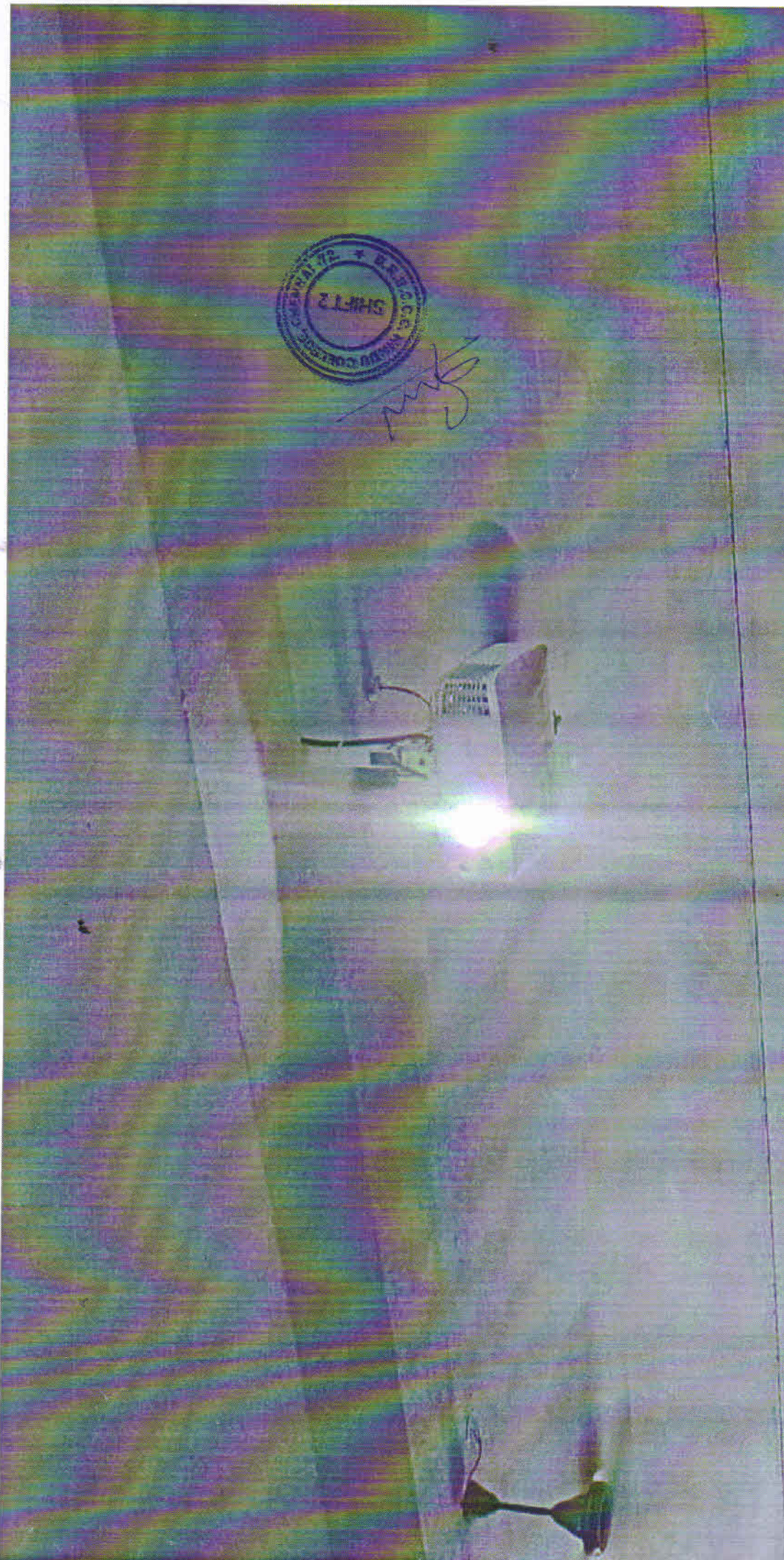

*Handwritten signature*



Pattabiram, Tamil Nadu, India  
 SCIENCE BLOCK, FOOD CORPORATION OF INDIA-PATTABIRAM, Deena Dayalan Nagar, Pattabiram,  
 Tamil Nadu 600054, India  
 Lat 13.121984°  
 Long 80.074005°  
 14/03/24 12:55 PM GMT +05:30

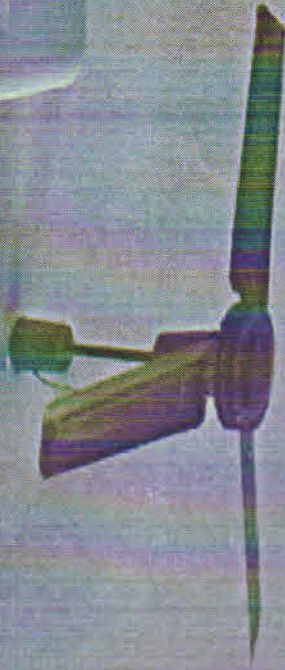
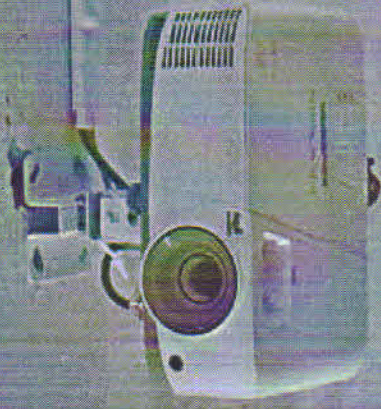

 GPS Map Camera



Pattabiram, Tamil Nadu, India  
SCIENCE BLOCK, FOOD CORPORATION OF INDIA-PATTABIRAM, Deena Dayalan Nagar, Pattabiram,  
Tamil Nadu 600054, India  
Lat 13.122018°  
Long 80.073917°  
14/03/24 12:54 PM GMT +05:30

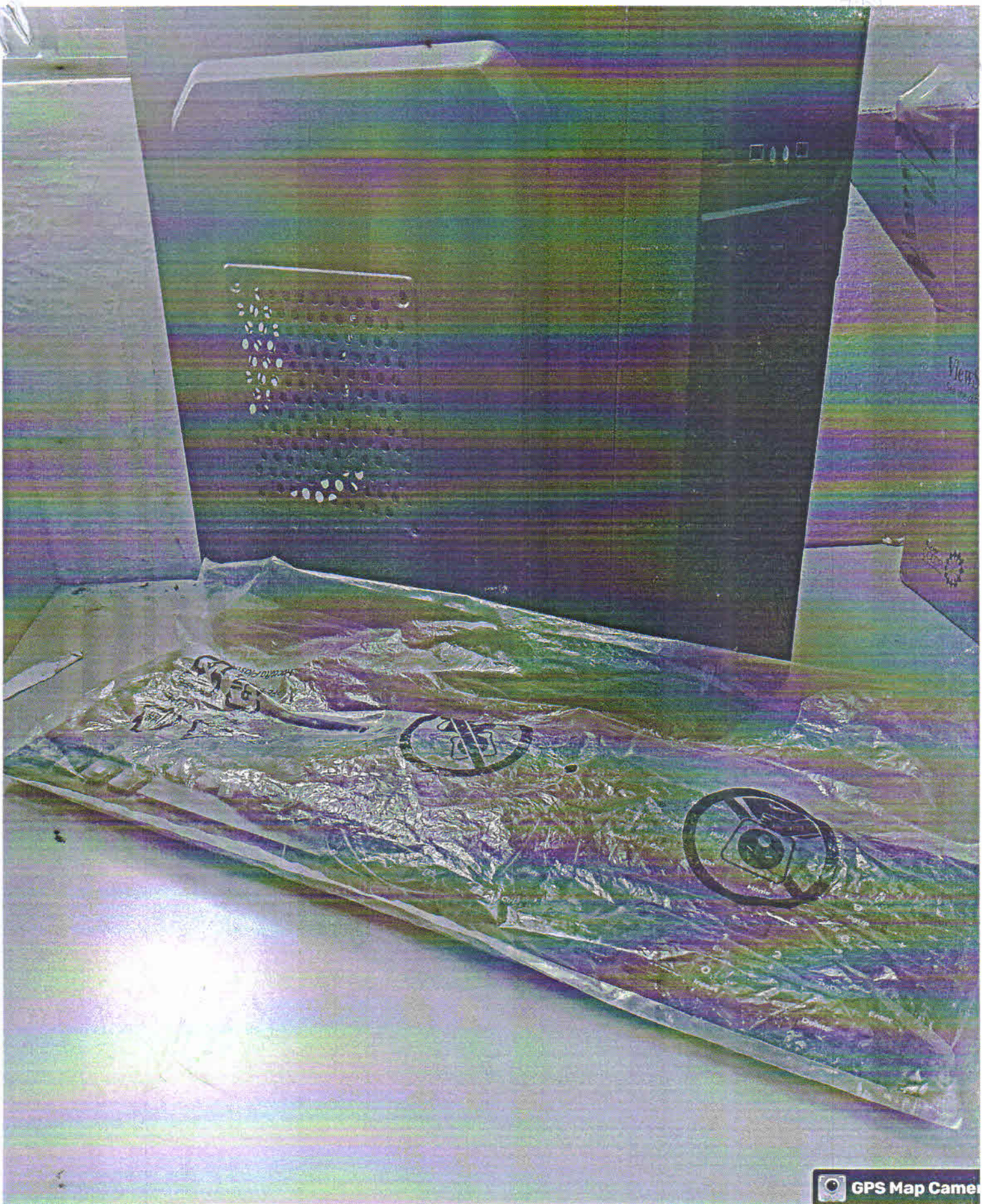

GPS Map Camera



Pattabiram, Tamil Nadu, India  
130, 10th St, Modern City, Deena Dayalan Nagar, Pattabiram, Tamil Nadu 600072, India  
Lat 13.1234°  
Long 80.07684°  
18/03/24 01:31 PM GMT +05:30

100 tools

### PEER TUTORING



GPS Map Camera

Google

**Pattabiram, Tamil Nadu, India**  
 SCIENCE BLOCK, FOOD CORPORATION OF INDIA-PATTABIRAM, Deena Dayalan  
 Nagar, Pattabiram, Tamil Nadu 600054, India  
 Lat 13.122308°  
 Long 80.074074°  
 27/10/23 01:14 PM GMT +05:30



GPS Map Camera

Google

**Pattabiram, Tamil Nadu, India**  
 SCIENCE BLOCK, FOOD CORPORATION OF INDIA-PATTABIRAM, Deena Dayalan  
 Nagar, Pattabiram, Tamil Nadu 600054, India  
 Lat 13.122308°  
 Long 80.074074°  
 27/10/23 01:14 PM GMT +05:30

*Indra*

*Indra*  
 Prof. Indhra M Mandey MBA..M.Phil.. M Com..  
 NET(MGT) Head -  
 Department of Business Administration (Shift 2)  
 Dharmamurthi Rao Bahadur Calavala Cunnan  
 Chetty's Hindu College.  
 Pattabiram, Chennai-600 072.



*Indra*

*Indra*

Prof. Indhra M Mandey MBA, M.Phil., M.Com.,  
 NET(MGT) Head -  
 Department of Business Administration (Shift 2)  
 Dharmamurthi Rao Bahadur Calavala Cunnan  
 Chetty's Hindu College,  
 Pattabiram, Chennai - 600 054

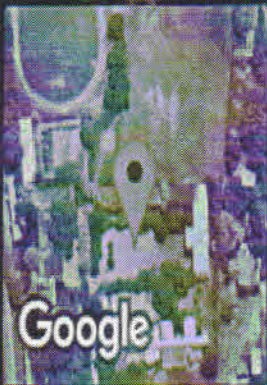
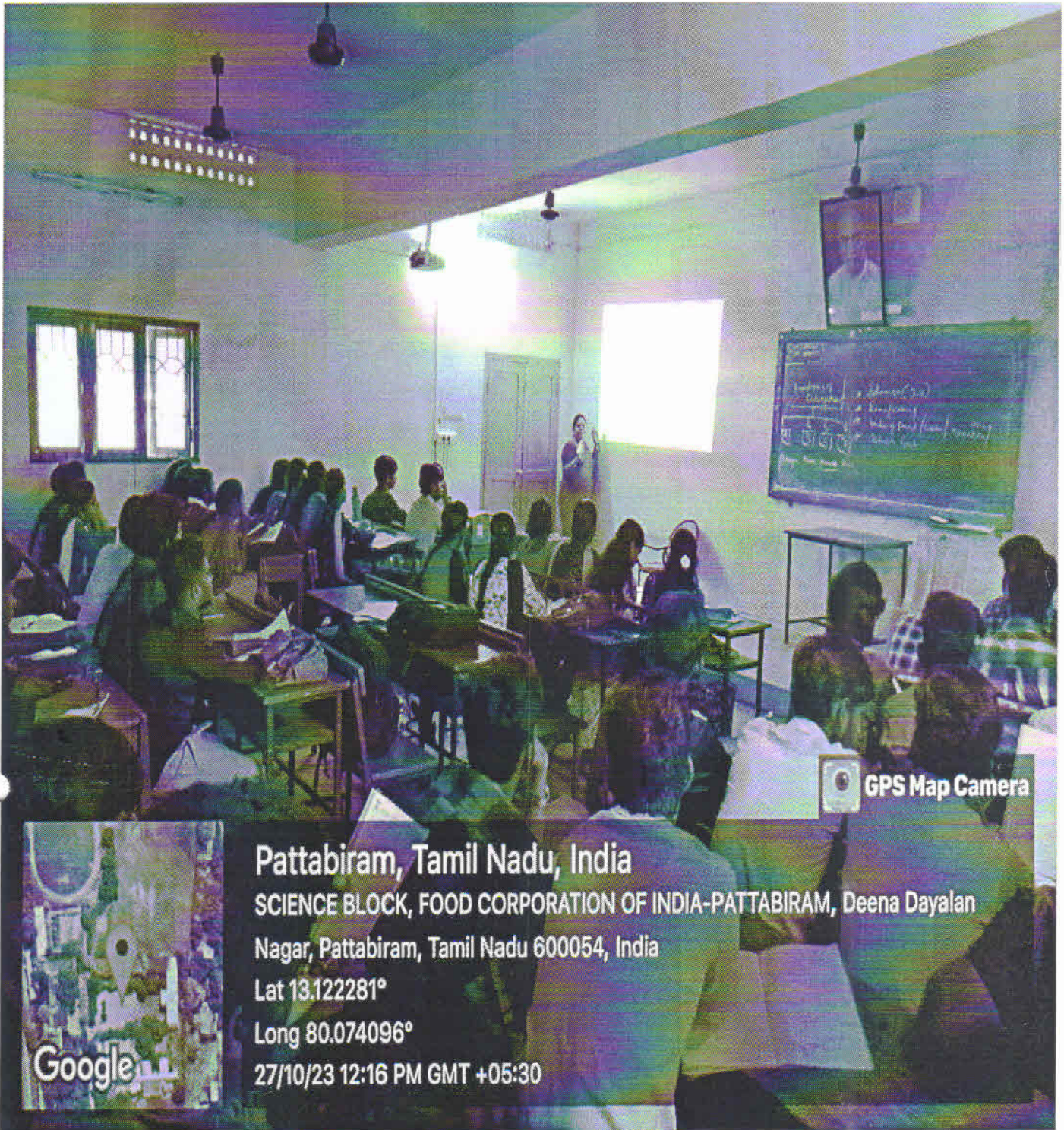

**Pattabiram, Tamil Nadu, India**

**SCIENCE BLOCK, FOOD CORPORATION OF INDIA-PATTABIRAM, Deena Dayalan**

**Nagar, Pattabiram, Tamil Nadu 600054, India**

**Lat 13.122281°**

**Long 80.074096°**

**27/10/23 12:16 PM GMT +05:30**

**GPS Map Camera**

*Indra*

*Indra*

**Prof.Indhra M Mandey MBA..M.Phil., M.Com.,**

**NET(MGT) Head -**

**Department of Business Administration (Shift 2)**

**Dharmamurthi Rao Bahadur Calavala Cunnan**

**Chetty's Hindu College.**

**Pattabiram, Chennai - 600 072.**

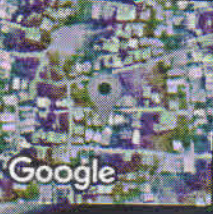

Avadi, Tamil Nadu, India  
 438F+F26, Avadi, Pattabiram, Tamil Nadu 600072, India  
 Lat 13.116405°  
 Long 80.072525°  
 27/10/23 01:28 PM GMT +05:30

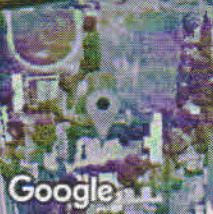

Pattabiram, Tamil Nadu, India  
 SCIENCE BLOCK, FOOD CORPORATION OF INDIA-PATTABIRAM, Deena Dayalan  
 Nagar, Pattabiram, Tamil Nadu 600054, India  
 Lat 13.12229°  
 Long 80.074081°  
 01/08/23 04:51 PM GMT +05:30

*[Handwritten signature]*

*[Handwritten signature]*  
 NET(MGT) Head -  
 Department of Business Administration (Shift 2)  
 Dharmamurthi Rao Bahadur Calavala Cunnah  
 Chetty's Hindu College,  
 Pattabiram, Chennai - 600 072.

Class settings

Save

## About

Title  
BBA DRBCCC 2225 MKT MGT

Description

Section  
A

Room  
3

Subject  
Marketing Management

## General

Student invitation settings

Class code: tmpptri

Invitation link:  
<https://classroom.google.com/c/NjE...>

Manage Meet link

17:27

45%



Indhra Mandey  
20 Oct 2023

Part B Past year Univ Q.Papers

### Attachments



Materials Management Par...

Save all files offline

Class comment

Prof. Indhra M Mandey MBA..M.Phil.. M Com..  
NET(MGT) Head -  
Department of Business Administration (Shift 2)  
Dharmamurthi Rao Bahadur Calavala Cunnar  
Chetty's Hindu College.  
Pattabiram, Chennai - 600 072.

Marketing Management

<https://classroom.google.com/c/NjU0NTE4Njg5OTE3?cjc=vx5ofqg>

### Recommended Texts

1. Philip Kotler, 2003, Marketing Management, 11<sup>th</sup> edition, Pearson Education (Singapore) Pte Ltd, NewDelhi.
2. V.S. Ramaswamy & S. Namakumari, 1994, Principles of Marketing, first edition, S.G. Wasani / Macmillan India Ltd, NewDelhi.
3. C. Rainfield, Marketing Management, Palgrave Macmillan
4. Sontakki . C.N , Marketing Management, Kalyani Publishers, Ludhiana
5. Gary Armstrong & Philip Kotler, 2003, Marketing - An Introduction, sixth edition, Pearson Education (Singapore) Pvt Ltd, NewDelhi.
6. R.S.N. Pillai and Bagavathi , Modern Marketing , S.Chand & Co , NewDelhi.
7. Jayasankar, Marketing, Margham Publications, Chennai.



**Prof. Indhra M Mandey** MBA..M.Phil.. M.Com.,  
NET(MGT) Head -  
Department of Business Administration (Shift 2)  
Dharmamurthi Rao Bahadur Calavala Cunnan  
Chetty's Hindu College,  
Pattabiram, Chennai - 600 072.

× Class settings

Save

## About

Title  
BBA DRBCCC 2225 MKT MGT

Description

Section  
A

Room  
3

Subject  
Marketing Management

## General

Student invitation settings

Class code: tmpptri

Invitation link:  
<https://classroom.google.com/c/NjE...>

Manage Meet link



Indhra Mandey

14 Jul 2023

Module 2 blended learning material

### Attachments

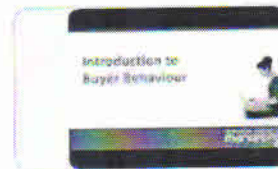

Consumer Buyer Behaviour

Class comment

**Prof. Indhra M Mandey** MBA, M.Phil., M.Com.,  
NET(MGT) Head -  
Department of Business Administration (Shift 2),  
Pharmamurthi Rao Bahadur Calavala Cunnan  
Chetty's Hindu College,  
Pattabiram, Chennai - 600 022.

## Material Management

<https://classroom.google.com/c/NjE1MTk0ODc2MTcy?cjc=no577vm>

### REFERENCE BOOKS:

1. P.Saravanel and S.sumathi, Production and Materials Management, Margham publications, 2015
2. M.M Verma, Materials Management, Sultan Chand Publications,2012.
3. Hill, Operations managent,PalgraveMacmillan.

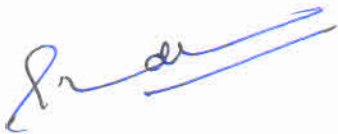

Prof.Indhra M Mandey MBA.,M.Phil., M Com.,  
NET(MGT) Head -  
Department of Business Administration (Shift 2)  
Dharmamurthi Rao Bahadur Calavala Cunnan  
Chetty's Hindu College.  
Pattabiram, Chennai - 600 072.

Class settings

Save



# About

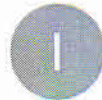

Indhra Mandey

20 Oct 2023

Part B Past year Univ Q.Papers

Title  
BBA DRBCCC 2124 MAT

Description

Section  
A

Room  
1

Subject  
Materials Management

## Attachments

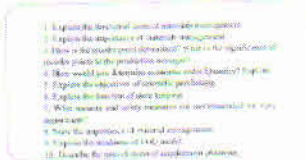

Materials Management Par...

Save all files offline

## General

Student invitation settings

Class code: no577vm

Invitation link:  
<https://classroom.google.com/c/NjE...>

Manage Meet link



*Indhra Mandey*  
PRINCIPAL,  
DHARMAMURTHI RAO BAHADUR CALAVALA CUNNAN  
CHETTY'S HINDU COLLEGE  
DHARMAMURTHI RAO BAHADUR BATTABIRAM,  
CHENNAI - 600 076.

Class comment

Prof.Indhra M Mandey MBA..M.Phil.. M Com.,  
NET(MGT) Head -  
Department of Business Administration (Shift 2)  
Dharmamurthi Rao Bahadur Calavala Cunnan  
Chetty's Hindu College

## Entrepreneurial Development

<https://classroom.google.com/c/NjE1MTk0ODQ3MDQ5?cjc=4lr2cbx>

### REFERENCE BOOKS:

1. Barringer, B., Entrepreneurship: Successfully Launching New Ventures, 3rd Edition, Pearson, 2011.
2. Bessant, J., and Tidd, J., Innovation and Entrepreneurship, 2nd Edition, John Wiley & Sons, 2011.
3. Desai, V., Small Scale Industries and Entrepreneurship, Himalaya Publishing House, 2011.
4. Donald, F.K., Entrepreneurship- Theory, Process and Practice, 9th Edition, Cengage Learning, 2014.
5. Hirsch, R.D., Peters, M. and Shepherd, D., Entrepreneurship, 6th Edition, Tata McGraw-Hill Education Pvt.Ltd., 2006.
6. Mathew, J.M., Entrepreneurship Theory at Cross Roads: Paradigms and Praxis, 2nd Edition, Dream Tech, 2006.
7. Morse, E., and Mitchell, R., Cases in Entrepreneurship: The Venture Creation Process, Sage South Asia, 2008.
8. Nagendra and Manjunath, V.S., Entrepreneurship and Management, Pearson, 2010.
9. Reddy, N., Entrepreneurship: Text and Cases, Cengage Learning, 2010.
10. Roy, R., Entrepreneurship, 2nd Edition, Oxford University Press, 2011.
11. Stokes, D., and Wilson, N., Small Business Management and entrepreneurship, 6th Edition, Cengage Learning, 2010.



Prof. Indhra M Mandey MBA, M.Phil., M.Com.,  
NET(MGT) Head -  
Department of Business Administration (Shift 2)  
Dharmamurthi Rao Bahadur Calavala Cunnan  
Chetty's Hindu College,  
Pattabiram, Chennai - 600 072.

Class settings

Save



# About

Title

BBA DRBCCC ED 2124

Description

Section

A

Room

2

Subject

Entrepreneurial Development

# General

Student invitation settings



Class code: 4lr2cbx

Invitation link:

<https://classroom.google.com/c/NjE...>



Manage Meet link



Indhra Mandey

20 Oct 2023

Past year univ part c q.papers

## Attachments

1. Distinguish between entrepreneur and professional manager.
2. Briefly explain the role of entrepreneurial development agencies in the promotion of industries.
3. Describe the contents of project feasibility study report.
4. Examine the role of entrepreneur in economic development.



ED Part C Past year Univ q papers.pdf

Save all files offline

Class comment

**Prof. Indhra M Mandey** MBA, M.Phil., M.Com.,  
 NET(MGT) Head -  
 Department of Business Administration (Shift 2)  
 Dharmamurthi Rao Bahadur Calavala Cunnan,  
 Chetty's Hindu College,  
 Pattabiram, Chennai - 600 072



# DHARMAMURTHI RAO BAHADUR CALAVALA CUNNAN CHETTY'S HINDU COLLEGE

DEPARTMENT OF BUSINESS ADMINISTRATION (SHIFT-II)

## REPORT ON PEER TUTORING

II BBA

DATE: 18:01:2024

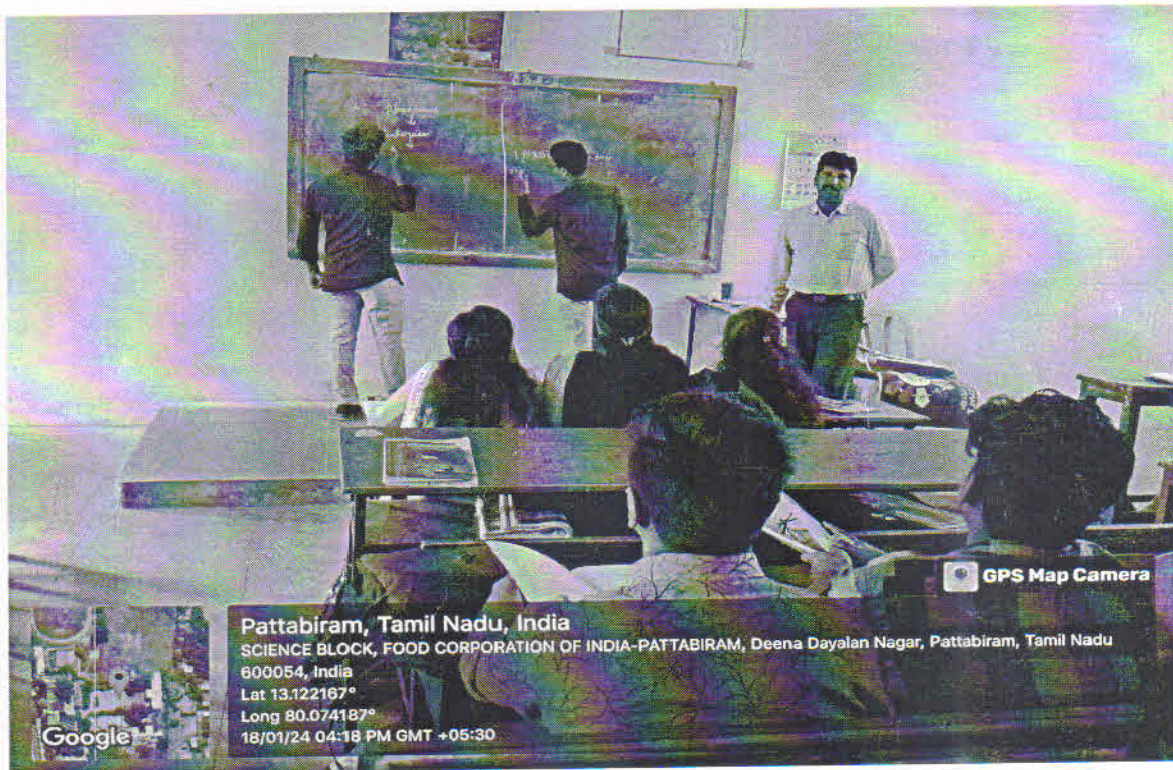

Prof. Indhra M. Mandey MBA M.Phil. M.Com.,  
NET(MGT) Head  
Department of Business Administration (Shift 2)  
Dharmamurthi Rao Bahadur Calavala Cunnan  
Chetty's Hindu College  
Pattabiram, Chennai - 600 072.

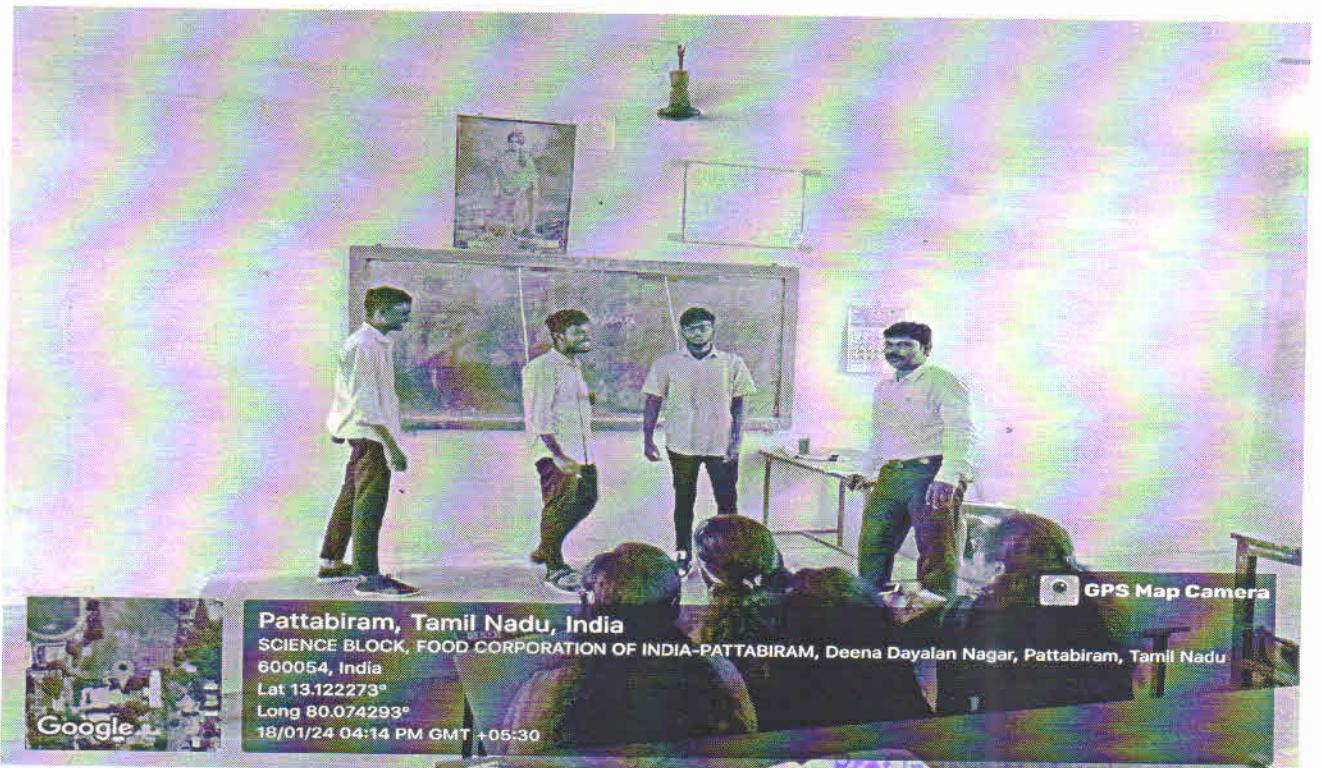

- 1 H. Mohit - Mohit-H
  - 2 R. MURUGAN - R. MUKESH
  - 3 S. Gowtham - S. Gowtham
  - 4 V. BHAVANESWARAN - V. BHAVANESWARAN
  - 5 D. KUNJA - D. THOMAS
  - 6 SATHYA KUMAR - SATHYA KUMAR
  - 7 P. PAWITRA - PAWITRA . P
  - 8 K. KANISHK - KANISHK .
- Peer Tutor

Polkaly  
 Dr. B. KALAYARASAN  
 Subject Handling  
 HOD

Department of Business Administration  
 Dharmamurthy Rao Bahadur Chetty's Hindu College  
 Pattabiram, Chennai - 600054

NETING  
 HOD



# DHARMAMURTHI RAO BAHADUR CALAVALA CUNNAN CHETTY'S HINDU COLLEGE

DEPARTMENT OF BUSINESS ADMINISTRATION (SHIFT-II)

## REPORT ON PEER TUTORING

III BBA

DATE: 18/01:2024

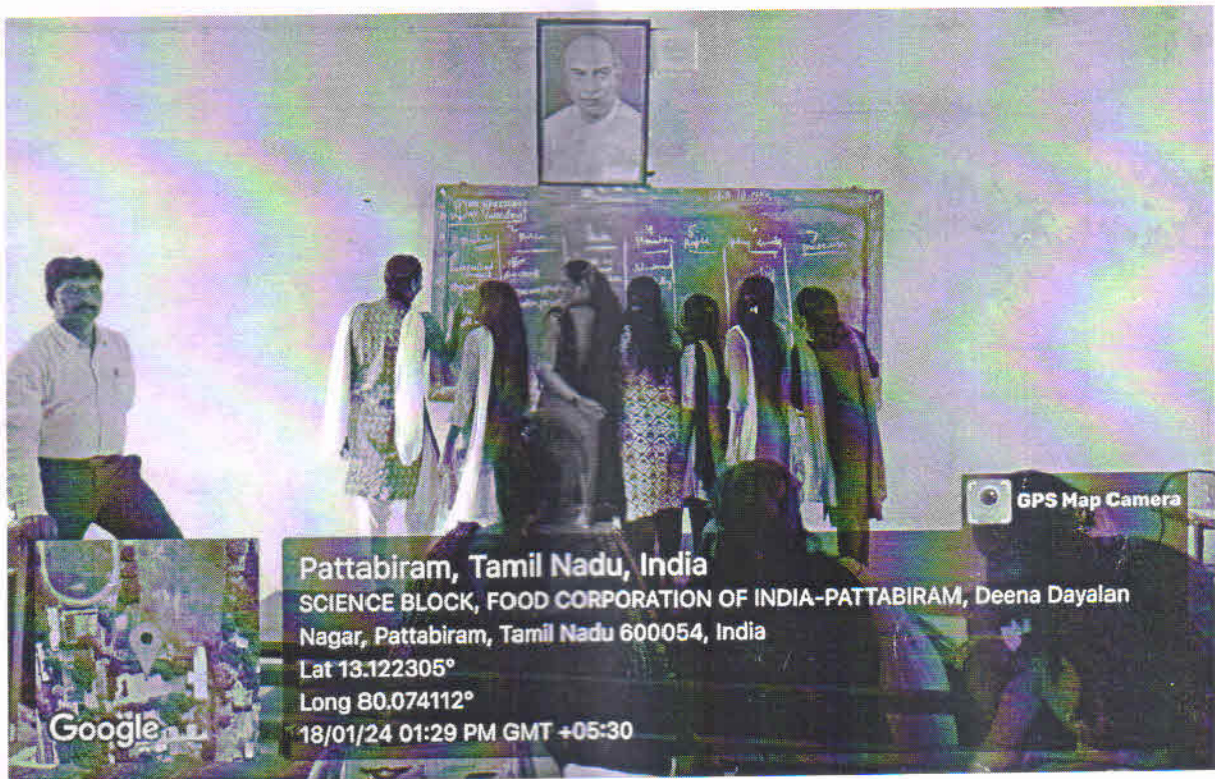

Prof. Indhra M Mandey MBA, M.Phil., M.Com.,  
NET/MGTI Head,  
Department of Business Administration (Shift-2)  
Dharmamurthi Rao Bahadur Calavala Cunnan  
Chetty's Hindu College  
Pattabiram, Chennai - 600 072



*G. Kalinrajan*  
PRINCIPAL,  
DHARMAMURTHI RAO BAHADUR CALAVALA CUNNAN  
CHETTY'S HINDU COLLEGE  
DHARMAMURTHI NAGAR, PATTABIRAM,  
CHENNAI - 600 072.



Pattabiram, Tamil Nadu, India  
 SCIENCE BLOCK, FOOD CORPORATION OF INDIA-PATTABIRAM, Deena Dayalan  
 Nagar, Pattabiram, Tamil Nadu 600054, India  
 Lat 13.121928°  
 Long 80.073904°  
 18/01/24 01:27 PM GMT +05:30

- 1 A-Abinaya (A.ABINAYA)
  - 2 P. Hamsaveni (P.HAMSAVENI)
  - 3 V. Swathi (V.SWATHI)
  - 4 R. Sowmya (R.SOWMYA)
  - 5 K. Swathi (K.SWATHI)
  - 6 S. Subathra (S.SUBATHRA)
  - 7 V. Kowsalya (V.KOWSALYA)
- Peer Tutor

*B. K. K...*  
 B. K. K...  
 Subject Handling  
 Faculty

*Pra...*  
 HOD

Prof. Indira M Mandev, BBA, M.Phil, M.Com  
 NET/MGT Head  
 Department of Business Administration (Unit 2)  
 Dharmamurthi Rao Bahadur Calavala Cunnam  
 Chetty's Hindu College  
 Pattabiram, Chennai - 600 072.



*G. Kalin...*  
 PRINCIPAL,  
 DHARMAMURTHI RAO BAHADUR CALAVALA CUNNAM  
 CHETTY'S HINDU COLLEGE  
 DHARMAMURTHI NAGAR, PATTABIRAM,  
 CHENNAI - 600 072.



**DHARMAMURTHI RAO BAHADUR CALAVALA  
CUNNAN CHETTY'S HINDU COLLEGE**

**DEPARTMENT OF BUSINESS ADMINISTRATION (SHIFT-II)**

**REPORT ON PEER TOURTUTING**

**ACCOUNTING FOR MANAGERS - II**

**Day 1: 20/02/2024**

**TOPIC: RATIO ANALYSE (FINANCIAL OR SOLVENCY RATIO)**

**Sum No: 29, 30, 31**

**H/W Sum No: 32, 33**



*Indhra M Mandey*

*G. Kalimuthu*

**PRINCIPAL,  
DHARMAMURTHI RAO BAHADUR CALAVALA CUNNAM  
CHETTY'S HINDU COLLEGE  
DHARMAMURTHI NAGAR, PATTABIRAM,  
CHENNAI - 600 072.**



**Prof. Indhra M Mandey MBA, M.Phil., M.Com.,  
NET/IGT Head,  
Department of Business Administration (Shift 2)  
Dharmamurthi Rao Bahadur Calavala Cunnam  
Chetty's Hindu College  
Pattabiram, Chennai - 600 072**

DAY 2: 06/03/2024

TOPIC: BUDGETING & BUDGETARY CONTROL (PRODUCTION BUDGET)

Q. No. 1, 2, 17

H/W Sum No: 18, 19, 20



Peer Tutor

*S. Charamathi*

S. Charamathi



*Dr. H-Divya*  
Subject Handler

Dr. H-DIVYA

HOD

*Indhu M Mandley*

*G. Kalpana*

PRINCIPAL

DHARMAMURTHI RAO BAHADUR CHETTY COLLEGE  
CHENNAI - 600 072



Geotag Photo

# PEER TUTORING



MDV Associates

*G. Kalinayana*

PRINCIPAL  
DRECCO HINDU COLLEGE (SINCE 1980)  
PATTABIRAM, CHENNAI - 600 072.

PRINCIPAL  
4th CROSS  
DRECCO HINDU COLLEGE  
PATTABIRAM, CHENNAI - 600 072.

Google



*[Signature]*  
Head

Department of Mathematics  
DRECCO Hindu College (SINCE 1980)  
Pattabiram, Chennai - 600 072.

Pattabiram Tamil Nadu India 28°C

SCIENCE BLOCK, FOOD CORPORATION  
OF INDIA-PATTABIRAM, Deena Dayalan

Lat: 13.12 | Long: 80.07  
10/01/2024 4:50 PM, IST

Cen  
31/10/23

DEPARTMENT OF  
BUSINESS  
ADMINISTRATION  
[SHIFT-02]

DRBCCC HINDU COLLEGE			
DEPARTMENT OF BUSINESS ADMINISTRATION SHIFT-II			
E-Learning Resources (ODD SEM)			
Dr. H. Divyaa			
2023-2024			
S.NO	YEAR	SEMESTER	SUBJECT
1	I BBA	1 <sup>st</sup> SEM	PRINCIPLES OF MANAGEMENT
2	II BBA	3 <sup>rd</sup> SEM	FINANCIAL MANAGEMENT
3	III BBA	5 <sup>th</sup> SEM	ADVERTISEMENT MANAGEMENT AND SALES PROMOTION

  
**COURSE INSTRUCTOR**  
**Dr. H- DIVYAA**

  
**HOD SIGNATURE**  
**Indhira M Mandey**

**Prof.Indhira M Mandey** MBA..M.Phil.. M Com.,  
 NET(MGT) Head -  
 Department of Business Administration (Shift 2)  
 Dharmamurthi Rao Bahadur Calavala Cunnan  
 Chetty's Hindu College,  
 Pattabiram, Chennai - 600 072.

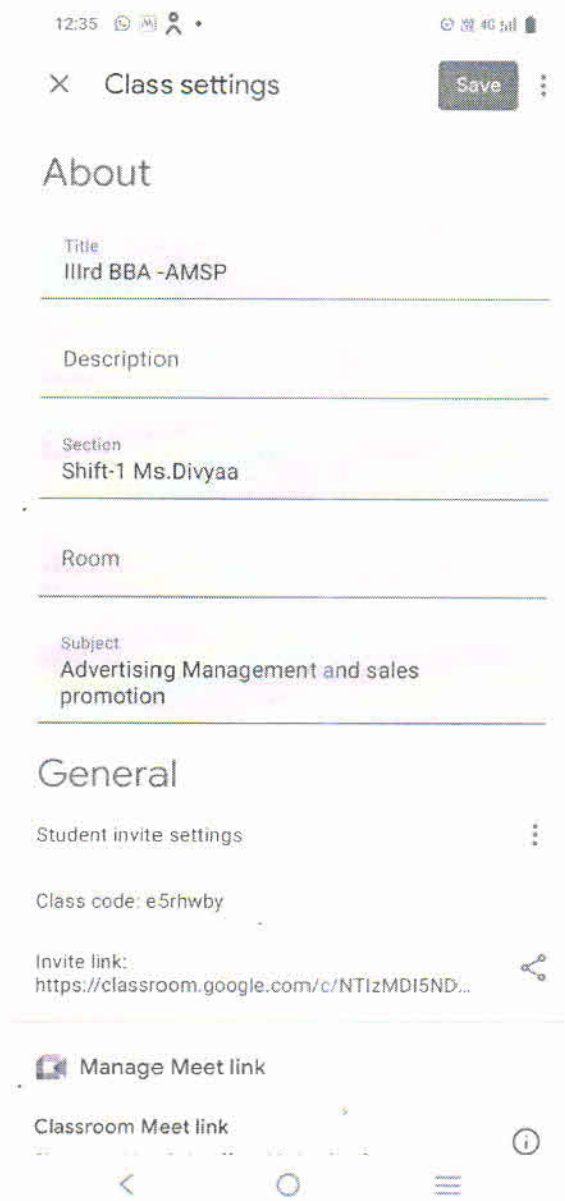
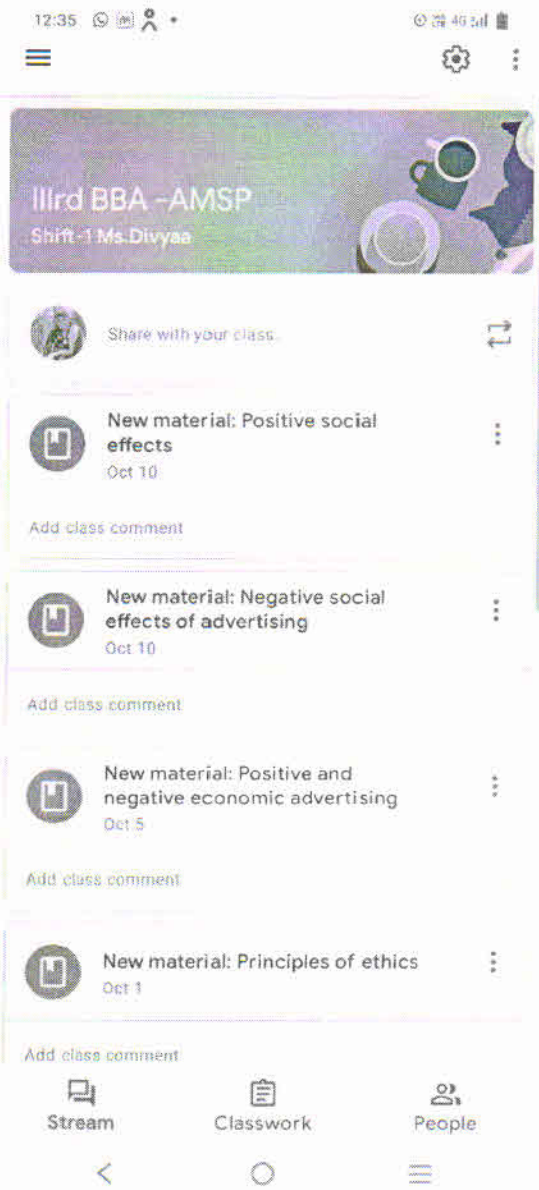

Prof.Indhira M Mandey MBA..M.Phil.. M Com.,  
 NET(MGT) Head -  
 Department of Business Administration (Shift 2)  
 Dharmamurthi Rao Bahadur Calavala Cunnan  
 Chetty's Hindu College,  
 Pattabiram, Chennai - 600 072.

*Indira*  
 Prof.Indhira M Mandey MBA..M.Phil.. M Com.,  
 NET(MGT) Head -  
 Department of Business Administration (Shift 2)  
 Dharmamurthi Rao Bahadur Calavala Cunnan  
 Chetty's Hindu College,  
 Pattabiram, Chennai - 600 072.

12:36 4G 511

11nd BBA - FM  
Shift-1 Ms.Divyaa

Share with your class...

New material: Unit 3 theory notes  
Sep 29

Add class comment

New material: Theory Notes  
Jul 21

Add class comment

New material: Captial structure  
PPT  
Jul 21

Add class comment

New material: Types of leverage  
Jul 7

Stream Classwork People

12:36 4G 511

Class settings Save

### About

Title  
11nd BBA - FM

Description

Section  
Shift-1 Ms.Divyaa

Room

Subject  
Financial Management

### General

Student invite settings

Class code: r5j7eif

Invite link:  
<https://classroom.google.com/c/NJE1MTk30T...>

Manage Meet link

Classroom Meet link  
Classroom Meet links offer added safety features.

Prof.Indhra M Mandey MBA, M.Phil., M.Com.,  
NET(MGT) Head -  
Department of Business Administration (Shift 2)  
Dharmamurthi Rao Bahadur Calavala Cunnan  
Chetty's Hindu College,  
Pattabiram, Chennai - 600 072.

*(Signature)*

Prof.Indhra M Mandey MBA, M.Phil., M.Com.,  
NET(MGT) Head -  
Department of Business Administration (Shift 2)  
Dharmamurthi Rao Bahadur Calavala Cunnan  
Chetty's Hindu College,  
Pattabiram, Chennai - 600 072.

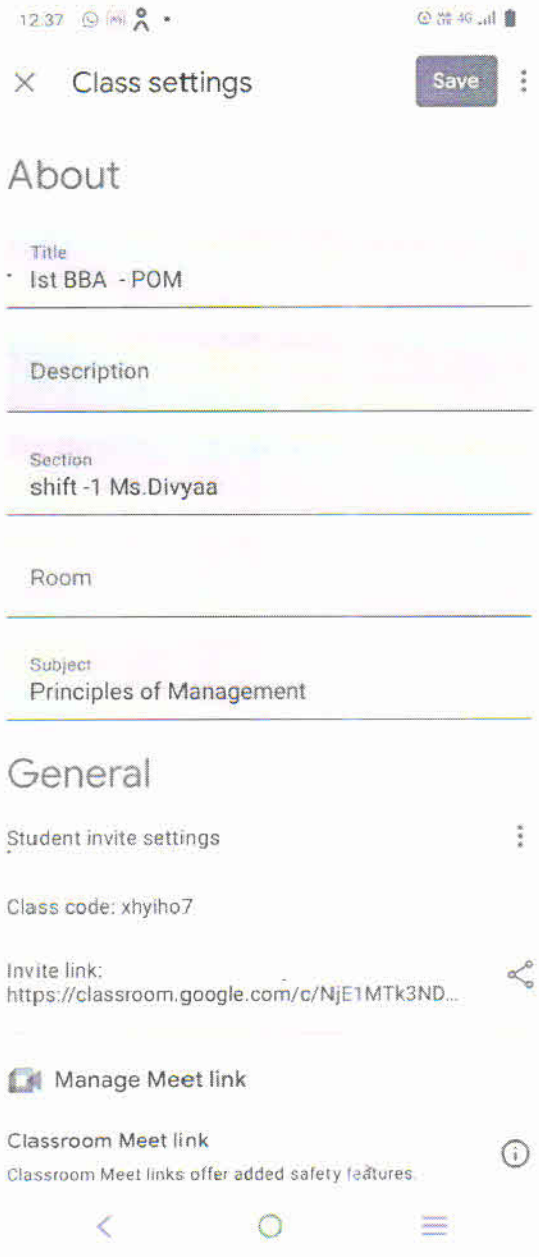
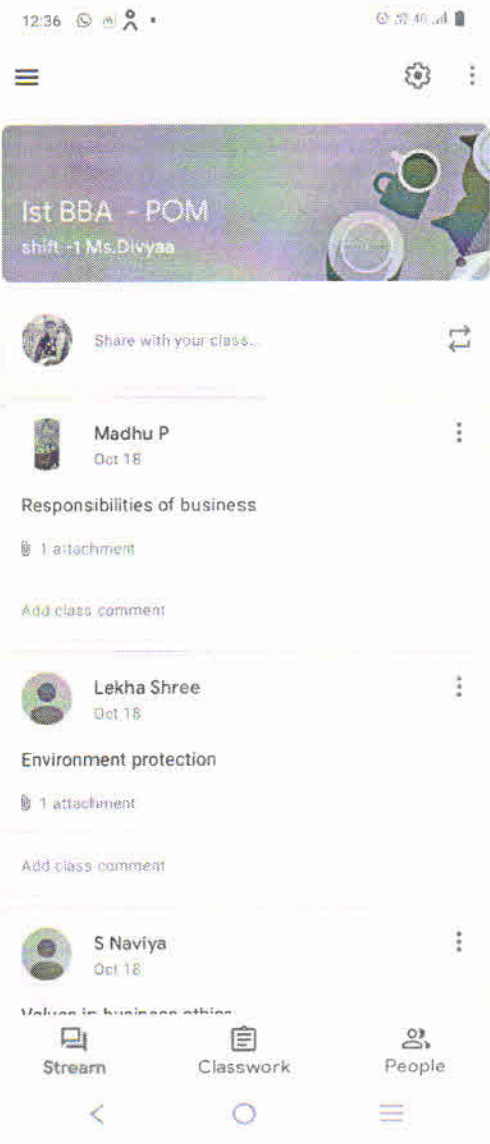

*Handwritten signature in blue ink.*

Prof.Indhra M Mandey MBA..M.Phil.. M Com.,  
NET(MGT) Head -  
Department of Business Administration (Shift 2)  
Dharmamurthi Rao Bahadur Calavala Cunnan  
Chetty's Hindu College,  
Pattabiram, Chennai - 600 072.

**Prof.Indhra M Mandey MBA..M.Phil.. M Com.,**  
NET(MGT) Head -  
Department of Business Administration (Shift 2)  
Dharmamurthi Rao Bahadur Calavala Cunnan  
Chetty's Hindu College,  
Pattabiram, Chennai - 600 072.

DRBCCC HINDU COLLEGE				
DEPARTMENT OF BUSINESS ADMINISTRATION SHIFT-II				
E-Learning Resources (ODD SEM)				
Dr. B. Kalaiyarasaran				
2023-2024				
S.NO	YEAR	SEMESTER	SUBJECT	RESOURCES
1	I BBA	1 <sup>st</sup> SEM	EVENT MANAGEMENT	<a href="https://classroom.google.com/c/NTMwMjE1MjI2NzI5?cjc=7injoqg">https://classroom.google.com/c/NTMwMjE1MjI2NzI5?cjc=7injoqg</a>
2	II BBA	3 <sup>rd</sup> SEM	ORGANISATIONAL BEHAVIOUR	<a href="https://classroom.google.com/c/NjMyMjUSNzU5MzQz?cjc=a5tir34">https://classroom.google.com/c/NjMyMjUSNzU5MzQz?cjc=a5tir34</a>
3	III BBA	5 <sup>th</sup> SEM	RESEARCH METHODOLOGY	<a href="https://classroom.google.com/c/NTMwMjE0NzU5MzQz?cjc=u3uj5ws">https://classroom.google.com/c/NTMwMjE0NzU5MzQz?cjc=u3uj5ws</a>

*B. Kalaiyarasaran*

COURSE INSTRUCTOR

*Judheer M Mandy*

HOD SIGNATURE

*Judheer M Mandy*

Prof. Indhiran M. Mandy, MBA, M.Phil., M.Com.,  
NE (MGT) Head -

Department of Business Administration (Shift 2)  
Dharmamurthi Rao Bahadur Calavala Cunnan  
Chetty's Hindu College,  
Pattabiram, Chennai - 600 072.

12:10

4G VoLTE



Share with your class...



New material: RM NOTES  
20 Oct



Add class comment



Stream



Classwork



People

12:10

4G VoLTE

Class settings

Save



## About

Title

III BBA - (RM) 23-24

Description

Section

Room

Subject

Research Methodology

## General

Student invitation settings



Prof. Indhira M. Mandey MBA, M.Phil., M.Com.,  
NET(MGT) Head -  
Department of Business Administration (Shift 2)  
Dharmamurthi Rao Bahadur Calavala Cunnar  
Dharmamurthi Rao Bahadur Calavala Cunnar  
Dharmamurthi Rao Bahadur Calavala Cunnar

Prof. Indhira M. Mandey MBA, M.Phil., M.Com.,  
NET(MGT) Head -  
Department of Business Administration (Shift 2)  
Dharmamurthi Rao Bahadur Calavala Cunnar  
Dharmamurthi Rao Bahadur Calavala Cunnar

12:08

4G VoLTE

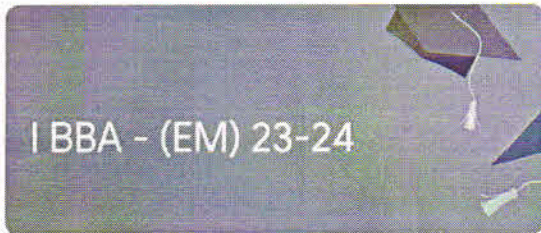

Share with your class...



New material: EVENT MANAGEMENT

20 Oct



Add class comment



Stream



Classwork



People

12:11

4G VoLTE



Class settings

Save



## About

Title

I BBA - (EM) 23-24

Description

Section

Room

Subject

EVENT MANAGEMENT

## General

Student invitation settings



**Prof. Indhra M Mandey** MBA, M.Phil., M.Com.,  
NET(MGT) Head -  
Department of Business Administration (Shift 2)  
Dharmamurthi Rao Bahadur Calavala Cunnan  
Chetty's Hindu College,  
Pattabiram, Chennai - 600 072.

**DRBCCC HINDU COLLEGE**  
**DEPARTMENT OF BUSINESS ADMINISTRATION SHIFT-II**

E-Learning Resources (ODD SEM)

**Prof. Indhra M Mandey**

**2023-2024**

S.NO	YEAR	SEMESTER	SUBJECT	RESOURCES
1	II BBA	3 <sup>rd</sup> SEM	Marketing Management	<a href="https://classroom.google.com/c/NjE1MTk3NzgwNjU4/p/NjE1NjE3MDIxMzly/details">https://classroom.google.com/c/NjE1MTk3NzgwNjU4/p/NjE1NjE3MDIxMzly/details</a>
2	III BBA	5 <sup>th</sup> SEM	Materials Management	<a href="https://classroom.google.com/c/NjE1MTk0ODc2MTcy?cjc=no577vm">https://classroom.google.com/c/NjE1MTk0ODc2MTcy?cjc=no577vm</a>
3	III BBA	5 <sup>th</sup> SEM	Entrepreneurial Development	<a href="https://classroom.google.com/c/NjE1MTk0ODQ3MDQ5?cjc=4lr2cbx">https://classroom.google.com/c/NjE1MTk0ODQ3MDQ5?cjc=4lr2cbx</a>

*(Indhra M Mandey)*

COURSE INSTRUCTOR

*(Indhra M Mandey)*

HOD SIGNATURE

*(Indhra M Mandey)*

**Prof. Indhra M Mandey** MBA, M.Phil., M.Com.,  
NET(MGT) Head -

Department of Business Administration (Shift 2)  
Dharmamurthi Rao Bahadur Calavala Cunnan  
Chetty's Hindu College.

16:15

32%

Class settings

Save

## About

Title  
BBA DRBCCC 2225 MKT MGT

Description

Section  
A

Room  
3

Subject  
Marketing Management

## General

Student invitation settings

Class code: tmpptri

Invitation link:  
<https://classroom.google.com/c/NjE...>

Manage Meet link

16:16

31%



Share with your class...



Indhra Mandey  
2 Oct



Question Bank Marketing

1 attachment

Add class comment



Indhra Mandey  
31 Jul



Module 2

1 attachment

Add class comment

Stream

Classwork

People

*(Indhra M Mandey)*

Prof. Indhra M Mandey MBA, M.Phil., M.Com.,  
NET(MGT) Head -  
Department of Business Administration (Shift 2)  
Dharmamurthi Rao Bahadur Calavala Cunnan  
Chetty's Hindu College,  
Pattabiram, Chennai - 600 072.

Prof. Indhra M Mandey MBA, M.Phil., M.Com.,  
NET(MGT) Head -  
Department of Business Administration (Shift 2)  
Dharmamurthi Rao Bahadur Calavala Cunnan  
Chetty's Hindu College,  
Pattabiram, Chennai - 600 072.

16:15

32%

Class settings

Save

# About

Title

BBA DRBCCC 2124 MAT

Description

Section

A

Room

1

Subject

Materials Management

# General

Student invitation settings

Class code: no577vm

Invitation link:

<https://classroom.google.com/c/NjE...>

Manage Meet link

12:36

4G

4G

Add class comment



New material: Unit-5 notes

Oct 15

Add class comment



New material: Unit -5 Business Ethics

Oct 11

Add class comment



New material: Unit - 4 notes

Sep 26

Add class comment



New material: Unit-3 continues notes of previous topics

Sep 19

Add class comment



New material: Unit 3 final notes

Aug 30

Add class comment



New material: Unit -3 notes

Stream

Classwork

People

*Indhra M Mandey*

**Prof.Indhra M Mandey** MBA.,M.Phil., M.Com.,  
NET(MGT) Head -  
Department of Business Administration (Shift 2)  
Dharmamurthi Rao Bahadur Calavala Cunnan  
Chetty's Hindu College,  
Pattabiram, Chennai - 600 072.

**DRBCCC HINDU COLLEGE**  
**DEPARTMENT OF BUSINESS ADMINISTRATION SHIFT-II**  
**E-Learning Resources (ODD SEM)**

**Dr. A. Kamalakannan**

**2023-2024**

S.NO	YEAR	SEMESTER	SUBJECT	RESOURCES
1	II BBA	3 <sup>rd</sup> SEM	COMPUTER APPLICATION IN BUSINESS	<a href="https://classroom.google.com/c/NjMxOTgzNjI2NzYz?cjc=i32y44t">https://classroom.google.com/c/NjMxOTgzNjI2NzYz?cjc=i32y44t</a>
2	III BBA	5 <sup>th</sup> SEM	OPERATION MANAGEMENT	<a href="https://classroom.google.com/c/NjMxOTgyMjEwNjY2?cjc=imbka5v">https://classroom.google.com/c/NjMxOTgyMjEwNjY2?cjc=imbka5v</a>
3	II BBM	3 <sup>rd</sup> SEM	MARKETING OF BANKING SERVICE	<a href="https://classroom.google.com/c/NjMyMjMwNzY4MDky?cjc=mqqyted">https://classroom.google.com/c/NjMyMjMwNzY4MDky?cjc=mqqyted</a>



**COURSE INSTRUCTOR**

**(A. Kamalakannan)**



**HOD SIGNATURE**

**Indhira M Mandey**

**Prof. Indhira M Mandey** MBA..M.Phil.. M.Com.  
NET(MGT) Head -  
Department of Business Administration (Shift II)  
Dharmamurthi Rao Bahadur Calavala Cunnna  
Chattya's Hindu College.

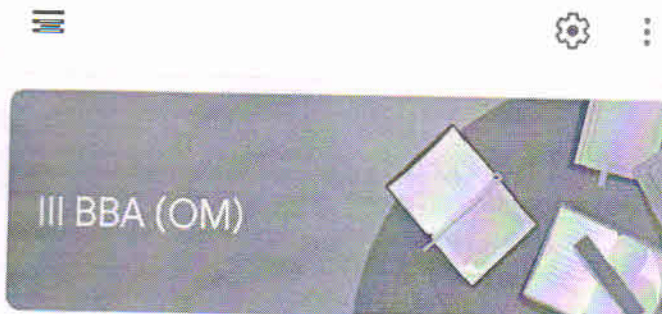

Share with your class...

KAMALAKANNAN A  
12:54  
OM\_Book\_Material\_reference  
1 attachment  
Add class comment

KAMALAKANNAN A  
12:53  
III\_BBA\_OM Notes  
1 attachment  
Add class comment

- Stream
- Classwork
- People

16:59 | 19.4KB/s

Class settings Save

### About

Title  
III BBA (OM)

Description

Section

Room

Subject  
Operations Management

### General

Student invitation settings

Class code: imbka5v

Invitation link:  
<https://classroom.google.com/c/NjMxOTgyMj...>

Manage Meet link

Classroom Meet link  
Classroom Meet links offer added safety features.

*Handwritten signature in blue ink*

*Handwritten signature in blue ink*

**Prof.Indhira M Mandey MBA..M.Phil.. M Com.,  
NET(MGT) Head -  
Department of Business Administration (Shift 2)  
Dharmamurthi Rao Bahadur Calavala Cunnan  
Chetty's Hindu College,  
Pattabiram, Chennai - 600 072.**

*Mirrored/bleed-through text from the reverse side of the page, including 'Prof. Indhira M Mandey' and 'Department of Business Administration'.*

II BBA (CAB)

Share with your class...

KAMALAKANNAN A  
13:34

II\_BBA\_CAB\_Notes-1

1 attachment

Add class comment

New material:  
II\_BBA\_CBA\_ED1\_Notes  
12:51

Add class comment

Stream

Classwork

People



*C. Kalikannan*

PRINCIPAL,  
DHARMAMURTHI RAO BAHADUR CALAVALA CUNNAN  
CHETTY'S HINDU COLLEGE  
DHARMAMURTHI NAGAR, PATTABIRAM,  
CHENNAI - 600 072.

*Prof. Indhra M. Mandey*

Prof. Indhra M. Mandey MBA, M.Phil., M.Com.,  
NET (MGT) Part 1 -  
Department of Business Administration (Shift 2)  
Dharmamurthi Rao Bahadur Calavala Cunnar  
Chetty's Hindu College,  
Pattabiram, Chennai - 600 072.

16:59 | 0.1KB/s



Class settings

Save

### About

Title  
II BBA (CAB)

Description

Section

Room

Subject  
Computer Application in Business

### General

Student invitation settings

Class code: i32y44t

Invitation link:  
<https://classroom.google.com/c/NjMxOTgzNjI...>

Manage Meet link

Classroom Meet link

Classroom Meet links offer added safety features.

Prof. Indhra M. Mandey MBA, M.Phil., M.Com.,  
NET (MGT) Part 1 -  
Department of Business Administration (Shift 2)  
Dharmamurthi Rao Bahadur Calavala Cunnar  
Chetty's Hindu College,  
Pattabiram, Chennai - 600 072.



Geotag Photo

I. B.Sc. C.S. (A)

DNB-7

# PEER TUTORING

Head  
Department of Mathematics  
DRSCCC Hindu College (Shift - 2)  
Pattabiram, Chennai - 600 072.



VDV Associates



4th Cro

Google

Hindu College

Pattabiram Tamil Nadu  
India

27°C

SCIENCE BLOCK, FOOD  
CORPORATION OF

Lat: 13.12 | Long: 80.07

10/01/2024 5:06 PM, IST

2.2

## VARIOUS INSTRUCTIONAL TECHNIQUES (ICT TOOLS, BOOKS, LINKS)

SL.NO	STAFF NAME	SUBJECT	ICT Tool	LINK
1.	Dr. V. Sasikala	Software Engineering	Google Classroom	<a href="https://classroom.google.com/c/NjUwNTYxOTU5MDk4?cjc=4ke3wyj">https://classroom.google.com/c/NjUwNTYxOTU5MDk4?cjc=4ke3wyj</a>
		Python	Google Classroom	<a href="https://classroom.google.com/c/MzY0MDUwMjI4MDkx?cjc=z6voyfr">https://classroom.google.com/c/MzY0MDUwMjI4MDkx?cjc=z6voyfr</a>
2.	Dr. M. Padmanaban	Cloud Computing	Google Classroom	<a href="https://classroom.google.com/c/NjMzMjgyOTg4NDcy">https://classroom.google.com/c/NjMzMjgyOTg4NDcy</a>
3.	Prof. P. Vinodhini	Software Engineering	Google Classroom	<a href="https://classroom.google.com/c/NjIyNjU0ODE0NjI3?cjc=3mzezpx">https://classroom.google.com/c/NjIyNjU0ODE0NjI3?cjc=3mzezpx</a>
		Mobile Computing	Google Classroom	<a href="https://classroom.google.com/c/NjIyNjU0NTA0NjE1?cjc=5beefnn">https://classroom.google.com/c/NjIyNjU0NTA0NjE1?cjc=5beefnn</a>
4.	Dr. K. Gurumoorthy	Java and Data Structure	Google Classroom	<a href="https://classroom.google.com/c/NjTU0NTE4MDE5NDI2?cjc=cieiznd">https://classroom.google.com/c/NjTU0NTE4MDE5NDI2?cjc=cieiznd</a>
		Data Science	Google Classroom	<a href="https://classroom.google.com/c/NjTIzMTEzOTQ0NjI4?cjc=yu5ihsc">https://classroom.google.com/c/NjTIzMTEzOTQ0NjI4?cjc=yu5ihsc</a>
5.	Prof. Prabhakaran S.	Data Science	Google Classroom	<a href="https://classroom.google.com/c/NjE1Nzg4NjA1MzIx?cjc=qosjmyo">https://classroom.google.com/c/NjE1Nzg4NjA1MzIx?cjc=qosjmyo</a>
		Mobile Computing	Google Classroom	<a href="https://classroom.google.com/c/NjE1NzkwOTMINTY3?cjc=3bbialw">https://classroom.google.com/c/NjE1NzkwOTMINTY3?cjc=3bbialw</a>
6.	Prof. S. Mahendran	Computer Organization And Architecture	Google Classroom	<a href="https://classroom.google.com/u/1/c/NjE2MDE1MzlwOTU1">https://classroom.google.com/u/1/c/NjE2MDE1MzlwOTU1</a>

*G. Kalinraaj*  
**PRINCIPAL,**  
 DHARMAMURTHI RAO BAHADUR, CALAVALA CUNNAN  
 CHETTY'S HINDU COLLEGE  
 DHARMAMURTHI NAQAR, PATTADIRAM,  
 CHENNAI - 600 072.



## ICT TOOLS, BOOKS, LINKS

S.NO	STAFF NAME	SUBJECT	LINK
1.	Dr. V. Sasikala	Software Engineering	<a href="https://docs.google.com/presentation/d/1BaB-x6O3IB_iBZ5Uu66ro41SFleDR-A4PEAVTYOugB0/edit?usp=drive_link">https://docs.google.com/presentation/d/1BaB-x6O3IB_iBZ5Uu66ro41SFleDR-A4PEAVTYOugB0/edit?usp=drive link</a> <a href="https://docs.google.com/presentation/d/18SfuBCb3J0mCkgsPYHdVFbKJchMLj9G">https://docs.google.com/presentation/d/18SfuBCb3J0mCkgsPYHdVFbKJchMLj9G</a>
2.	Prof. S. Prabhakaran	Data Science	<a href="https://docs.google.com/document/d/1GsZ6-loqXwDSfWieZmMVZMoJLHrM9RoZvb4V-bGJxil">https://docs.google.com/document/d/1GsZ6-loqXwDSfWieZmMVZMoJLHrM9RoZvb4V-bGJxil</a>



*G. Kalinraj*

PRINCIPAL,  
DHARMAMURTHI RAO BAHADUR CALAVALA CUNNAM  
CHETTY'S HINDU COLLEGE  
DHARMAMURTHI RAO PATTABIRAM,  
CHENNAI - 600 072.

9.2.20

22

**DEPARTMENT OF BCOM ISM**

**REPORT ON PEER TEACHING**

**FOR THE ACADEMIC YEAR**

**2023-2024**

**DHARMAMURTHI RAO BAHADUR CALAVALA CUNNAN CHETTY'S**  
**HINDU COLLEGE**

**DEPARTMENT OF B.COM(ISM)**

Report on "Peer Teaching"

30/01/2024



**Learning Objective:**

- To develop communication and presentation skills of the students.
- To foster teamwork and collaboration among peers in teaching and learning.
- To apply management concepts to real-world scenarios through peer-led discussions and activities.

**Outcome:**

- The BCOM ISM department organized a **Peer Teaching** for second year students on the topic "Principles of Management" on January 30<sup>th</sup>, 2024 at 3<sup>rd</sup> .COM ISM classroom. This session was presented by Sivaraam, Lakshmipriya, Swathi, Priyadharshini (3<sup>rd</sup> year students) under the headship of Dr. Premila Koppalakrishnan.
- Peer teaching encourages active engagement and participation among students, as they take on the role of both teacher and learner. This can enhance their understanding of the material and improve retention.
- Peer teaching fosters collaboration and communication skills, as students work together to explain concepts and provide feedback to their peers, this will not only

strengthens their learning, but also prepares them for real-world situations where teamwork is essential for success.

- Overall, peer teaching can be an effective and enriching educational strategy in the study of management principles.

### Feedback responses

- Received 47 responses from 2<sup>nd</sup> years students

How interactive was the peer teaching session ?

47 responses

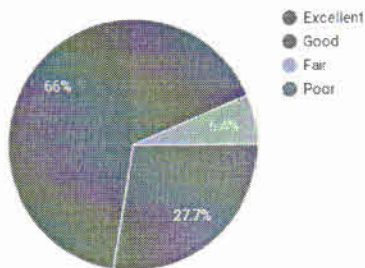

Were your expectations met regarding the session Objective ?

47 responses

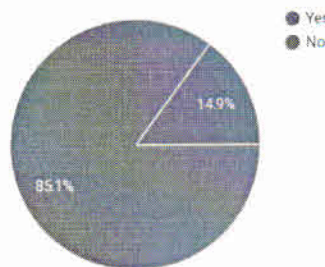

Is it easy to follow and understand

47 responses

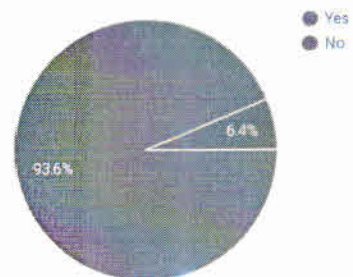

Did the Content of the event was accurately described ?

47 responses

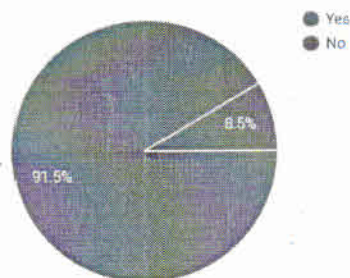

Will you Recommended this type of type of teaching in future ?

47 responses

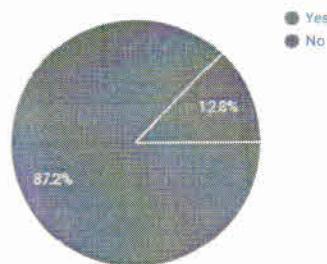



Dharmamurthi Rao Bahadur  
Calavala Cunnan Chetty's Hindu College (SHIFT - 2)  
(Accredited by NAAC)

Dharmamurthi Nagar, Pattabiram, Chennai - 72  
www.drbcchinducollege.ac.in

Degree : **B.Com.I.S.M**

Batch : **2022-2023**

Sl. No.	RollNo	UnivRegNo	Name	
				MALE - Tamil
1	22IS101	422200046	DEEPAK RAM R	P. Deepak Ram
2	22IS102	422200047	DEEPAK T	T. Deethan
3	22IS103	422200048	DHEEPAK M	AAA
4	22IS104	422200049	GANESH A	Ganesh - A
5	22IS105	422200050	HARIHARAN V	U. Hariharan
6	22IS106	422200051	JITHESH SRINATH R	R. Jithesh
7	22IS107	422200052	JOTHISHWARAN U	U. Jothishwaran
8	22IS108	422200053	KAMALESH BORANA J	J. Kamal
9	22IS109	422200054	MANOJ KUMAR J	J. Manoj
10	22IS110	422200056	MOHAMED AZARUDIN ANSARI T	T. Mohamed Azharudin
11	22IS111	422200055	MOHAMED HASSAN FAROOK A	MOHAMED HASSAN FAROOK A
12	22IS112	422200057	MOHAN T	T. Mohan
13	22IS113	422200058	NAVEEN KUMAR M	M. Naveen
14	22IS114	422200059	NAVEEN KUMAR V	V. Naveen
15	22IS115	422200060	PANDEES WARAN A	A. Pandeeswaran
16	22IS116	422200061	RAKESH S	AAA
17	22IS117	422200062	ROHITH C	Rohith C
18	22IS118	422200063	SAMUVEL K	K. Samuvel
19	22IS119	422200064	SOLAI RAJA S	S. Solai Raja
20	22IS120	422200065	SUDHARSAN KUMAR M	M. Sudharsan
21	22IS121	422200066	TAMILVANAN K	K. Tamilvanan
22	22IS122	422200067	TILIP KUMAR C	C. Tilip Kumar
23	22IS123	422200068	VENKATESH S	AAA
24	22IS124	422200069	VINOTH KUMAR K	K. Vinoth Kumar

Sl. No.	RollNo	UnivRegNo	Name	
<b>FEMALE - Tamil</b>				
25	22IS125	422200070	AATHI SHAKTHI R	<del>R. Athi Shakthi</del> M. Abinaya
26	22IS126	422200071	ABINAYA M	
27	22IS127	422200073	DATCHAYANI G	AAA
28	22IS128	422200074	DEEPIKA N	N. Deepika
29	22IS129	422200075	DEEPIKA S	<del>D. Deepika</del> B. Dhanalakshmi
30	22IS130	422200076	DHANALAKSHMI B	
31	22IS131	422200077	DIVYA B	B. Divya
32	22IS132	422200078	HARI PRIYA G	G. Hari Priya
33	22IS133	422200079	ILUCKYA K	K. Iluckya
34	22IS134	422200080	INDUMATHI S	S. Indumathi
35	22IS135	422200081	JANANEE U	U. Jananee
36	22IS136	422200082	KANMANI S	S. Kanmani
37	22IS137	422200083	KARPAGAM N	N. Karpagam
38	22IS138	422200084	NITHYA B	B. <del>Nithya</del> AAA
39	22IS139	422200085	POOJA S	AAA
40	22IS140	422200086	PRIYADHARSHINI K	AAA
41	22IS141	422200087	PUNITHA G	Punitha G
42	22IS142	422200088	RANJANI P	P. Ranjana
43	22IS143	422200089	SANDHYA DEVI N	N. Sandhya Devi
44	22IS144	422200090	SANGEETHA M	M. Sangeetha
45	22IS145	422200091	SHALINI K	Shalini K
46	22IS146	422200092	SHALINI L	L. shalini
47	22IS148	422200094	SNEKA T G	T. Sneka
48	22IS149	422200096	VAISHNAVI K	K. <del>Vaishnavi</del>
<b>FEMALE - TELUGU</b>				
49	22IS151	422200072	CHAREESHMA SK	AAA
<b>FEMALE - HINDI</b>				
50	22IS150	422200095	SWATHI S	AAA

R  
29/1/24

From  
Dr.Premila Kopalakrishnan  
Head of the Department  
Department of Information System Management  
DRBCCC Hindu College,  
Pattabiram, Chennai- 72

29/01/2024

To  
The Director/ Principal,  
DRBCCC Hindu College,  
Pattabiram, Chennai- 72

Subject: Requesting permission to conduct peer teaching session by final years(IQAC -Advance learners-2.2.1)

Respected Sir/Ma'am

We BCOM (ISM) department are planning to conduct a peer team presentation session of our final years to Sophomore -( 2nd Year students ) on 30, Jan 2024 from 10 to 12.00 in the management course .  
So kindly permit our second years to attend college at 10 am in the morning.

**Peer Team (Management course)**

**Priyadharshini**

**Lakshmi Priya**

**Swathi Suresh**

**Sivaraman**

Regards  
Dr.Premila Kopalakrishnan



Head of The Department  
Information Systems and Management  
DHARMAMURTHI RAO BAHADUR CALAVALA  
CUNNAN CHETTY'S HINDU COLLEGE  
DHARMAMURTHI NAGAR  
PATTABIRAM CHENNAI-500 072

*C. Arinavaraj*  
PRINCIPAL,  
DHARMAMURTHI RAO BAHADUR CALAVALA CUNNAM  
CHETTY'S HINDU COLLEGE  
DHARMAMURTHI NAGAR, PATTABIRAM,  
CHENNAI - 600 072.

**Department of Statistics**

**E-Learning Resources**

11wlc  
7.2.1

S.No.	Name of the book	Link for the book
1.	Statistical Methods for Practice and Research	<a href="https://drive.google.com/file/d/1Fr9E4ClrdIOEyELA5kTA5iTTAuVJepdr/view?usp=sharing">https://drive.google.com/file/d/1Fr9E4ClrdIOEyELA5kTA5iTTAuVJepdr/view?usp=sharing</a>
2.	Introduction to Probability and Statistics Using R	<a href="https://drive.google.com/file/d/0BxTQJz6dVMxZOUFMOGIOcW1GS00/view?usp=sharing&amp;resourcekey=0-hTWr5SJ4Xa777kmBXkQ8og">https://drive.google.com/file/d/0BxTQJz6dVMxZOUFMOGIOcW1GS00/view?usp=sharing&amp;resourcekey=0-hTWr5SJ4Xa777kmBXkQ8og</a>
3.	Statistical Analysis With Excel for Dummies	<a href="https://drive.google.com/file/d/1-d7U1cRrL1ET8WoCysseUEmFD_McOJk/view?usp=sharing">https://drive.google.com/file/d/1-d7U1cRrL1ET8WoCysseUEmFD_McOJk/view?usp=sharing</a>
4.	Basic Statistics with R	<a href="https://drive.google.com/file/d/1FLWFcqyLI7OgRZz-wkP5OBVJzBBaKLEs/view?usp=sharing">https://drive.google.com/file/d/1FLWFcqyLI7OgRZz-wkP5OBVJzBBaKLEs/view?usp=sharing</a>
5.	Microsoft Excel Functions and Formulas	<a href="https://drive.google.com/file/d/1sWf3SaR9Qh7VzLhmACdyvW9DymdKszsj/view?usp=sharing">https://drive.google.com/file/d/1sWf3SaR9Qh7VzLhmACdyvW9DymdKszsj/view?usp=sharing</a>
6.	Introduction to Linear Regression Analysis	<a href="https://drive.google.com/file/d/1-RG1tV7gaAK4aEBSj7WChMfeT8TqmPmC/view?usp=sharing">https://drive.google.com/file/d/1-RG1tV7gaAK4aEBSj7WChMfeT8TqmPmC/view?usp=sharing</a>
7.	Linear Algebra	<a href="https://drive.google.com/file/d/1053nV1mIK9i97JL1bhYV6p5c5rIhzzHa/view?usp=sharing">https://drive.google.com/file/d/1053nV1mIK9i97JL1bhYV6p5c5rIhzzHa/view?usp=sharing</a>
8.	Introductions to time series analysis and forecasting.	<a href="https://drive.google.com/file/d/12sBl-g_KxtSNOqKXLMY7IDwPP-zpPkP/view?usp=drivesdk">https://drive.google.com/file/d/12sBl-g_KxtSNOqKXLMY7IDwPP-zpPkP/view?usp=drivesdk</a>
9.	Fundamental of mathematical statistics.	<a href="https://drive.google.com/file/d/12u2sx1aU5obYFhOap66oFiPEkWWorxVT/view?usp=drivesdk">https://drive.google.com/file/d/12u2sx1aU5obYFhOap66oFiPEkWWorxVT/view?usp=drivesdk</a>
10.	An introduction to probability and statistics.	<a href="https://drive.google.com/file/d/13ExzffBAb4U9r8Oyh5HepcKxLY7d8Cv6/view?usp=drivesdk">https://drive.google.com/file/d/13ExzffBAb4U9r8Oyh5HepcKxLY7d8Cv6/view?usp=drivesdk</a>
11.	Introduction to linear regression analysis.	<a href="https://drive.google.com/file/d/139a2NfaR9P04P5iPvxbyllab4guUNJlo/view?usp=drivesdk">https://drive.google.com/file/d/139a2NfaR9P04P5iPvxbyllab4guUNJlo/view?usp=drivesdk</a>
12.	Time series analysis and its application with r example.	<a href="https://drive.google.com/file/d/13B2ACVKCsXK_BXquDh7My_lq53_duB8/view?usp=drivesdk">https://drive.google.com/file/d/13B2ACVKCsXK_BXquDh7My_lq53_duB8/view?usp=drivesdk</a>
13.	Introductory econometrics.	<a href="https://drive.google.com/file/d/137ZR31QIkEzDM8W0k38sid107uRr_tJ5/view?usp=drivesdk">https://drive.google.com/file/d/137ZR31QIkEzDM8W0k38sid107uRr_tJ5/view?usp=drivesdk</a>

SYSTEMS

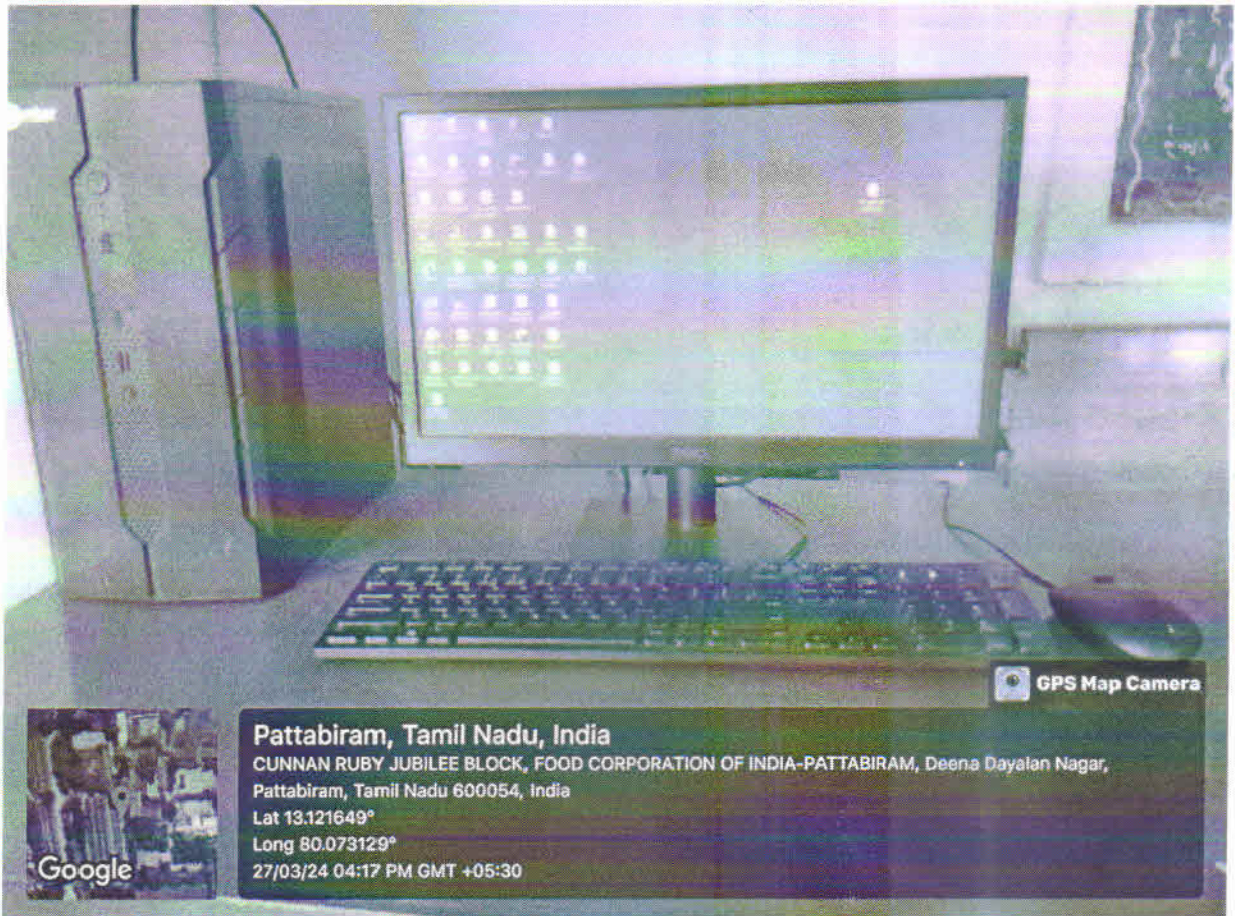

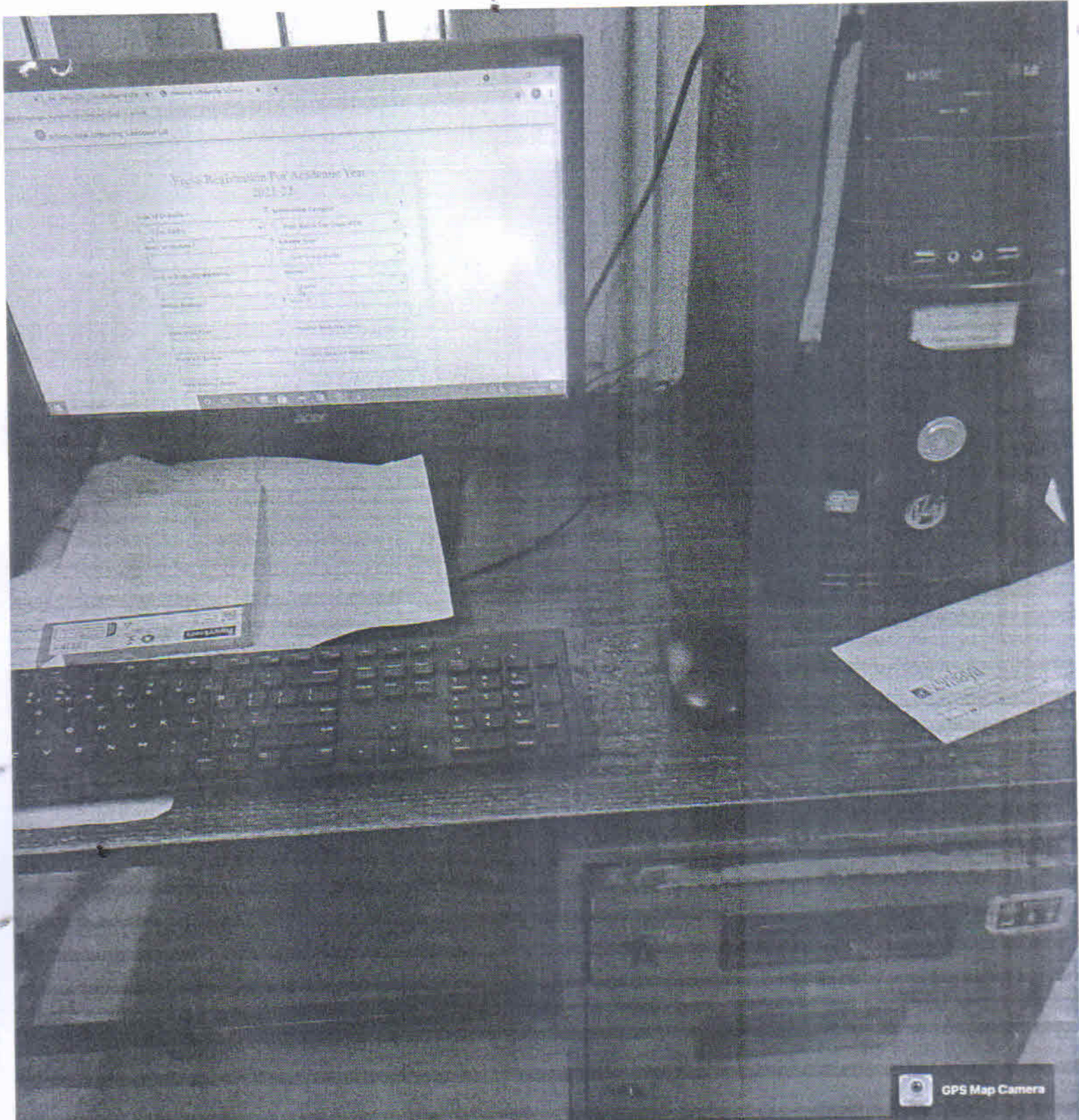

GPS Map Camera



**Department of Social Work**  
Equipment - System DRBCCC HINDU COLLEGE  
PATTABIRAM, Tamil Nadu 600054, India  
Lat 13.122249°  
Long 80.074232°  
25/10/21 02:50 PM

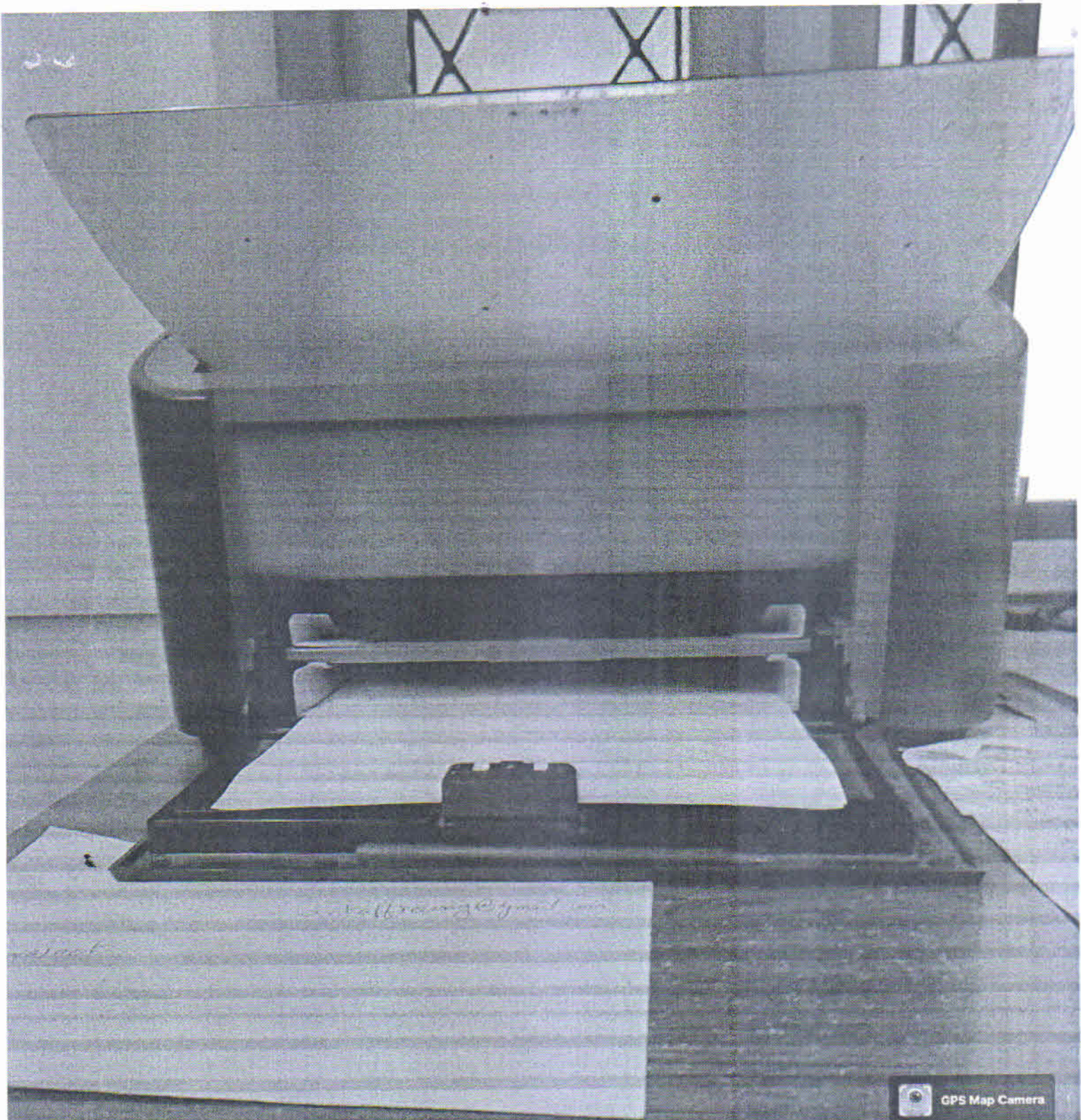

GPS Map Camera



## Department of Social Work

Equipment - Printer DRBCCC HINDU COLLEGE

PATTABIRAM, Tamil Nadu 600054, India

Lat 13.122249°

Long 80.074232°

25/10/21 02:50 PM

GPS Map Camera

## Pattabiram, Tamil Nadu, India

MSW M&P Classroom 21-22 DRBCCC HINDU COLLEGE PATTABIRAM,

Tamil Nadu 600054, India

Lat 13.122249°

Long 80.074232°

25/10/21 01:34 PM

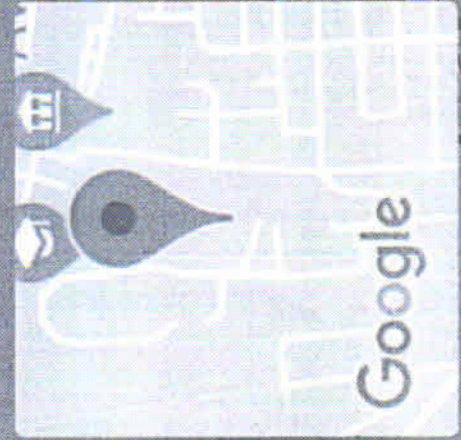

**DRBCCC HINDU COLLEGE**

**DEPARTMENT OF BUSINESS ADMINISTRATION SHIFT-II**

**E-Learning Resources (ODD SEM)**

**Dr. B. Kalaiarasaran**

**2023-2024**

S.NO	YEAR	SEMESTER	SUBJECT	RESOURCES
1	I BBA	1 <sup>st</sup> SEM	EVENT MANAGEMENT	<a href="https://classroom.google.com/c/NTMwMjE1MjI2NzI5?cjc=7injoqg">https://classroom.google.com/c/NTMwMjE1MjI2NzI5?cjc=7injoqg</a>
2	II BBA	3 <sup>rd</sup> SEM	ORGANISATIONAL BEHAVIOUR	<a href="https://classroom.google.com/c/NjMyMjU5NzU5MzQz?cjc=a5tir34">https://classroom.google.com/c/NjMyMjU5NzU5MzQz?cjc=a5tir34</a>
3	III BBA	5 <sup>th</sup> SEM	RESEARCH METHODOLOGY	<a href="https://classroom.google.com/c/NTMwMjE0Nzg1NDkz?cjc=u3uj5ws">https://classroom.google.com/c/NTMwMjE0Nzg1NDkz?cjc=u3uj5ws</a>



**COURSE INSTRUCTOR**



**HOD SIGNATURE**

**Prof. Indira . M. Mandeey** MBA, M.Phil., M.Com.  
NET(MGT) Head -

Department of Business Administration (Shift 2)  
**Dharmamurthi Rao Bahadur Calavala Cunnan**

Chetty's Hindu College,

Pattabiram - Chennai - 600 072.

12:08

4G VoLTE

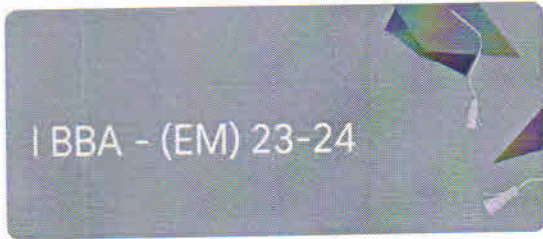

Share with your class...



New material: EVENT MANAGEMENT

20 Oct



Add class comment

Stream

Classwork

People

*B. W. ...*

12:11

4G VoLTE

Class settings

Save



## About

Title

I BBA - (EM) 23-24

Description

Section

Room

Subject

EVENT MANAGEMENT

## General

Student invitation settings



12:09

4G VoLTE

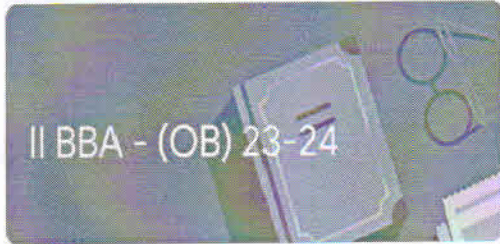

Share with your class...



New material: OB NOTES  
20 Oct (Edited 20 Oct)

Add class comment

Stream

Classwork

People

*B. Lohar*



12:11

4G VoLTE

Class settings

Save

## About

Title

II BBA - (OB) 23-24

Description

Section

Room

Subject

ORGANISATIONAL BEHAVIOUR

## General

Student invitation settings

*G. Mahalingam*  
PRINCIPAL,  
DHARMAMURTHI RAO SAHAJUR GALAVALA CUNNAM  
CHETTY'S HINDU COLLEGE  
DHARMAMURTHI NAGAR, PATTABIRAM,  
CHENNAI - 600 072.

<b>DRBCCC HINDU COLLEGE</b>				
<b>DEPARTMENT OF BUSINESS ADMINISTRATION SHIFT-II</b>				
<b>E-Learning Resources (ODD SEM)</b>				
<b>Dr. H. Divyaa</b>				
<b>2023-2024</b>				
S.NO	YEAR	SEMESTER	SUBJECT	RESOURCES
1	I BBA	1 <sup>st</sup> SEM	PRINCIPLES OF MANAGEMENT	<a href="https://classroom.google.com/c/NjE1MTk3NDU14Mjgz?cjc=xhyiho7">https://classroom.google.com/c/NjE1MTk3NDU14Mjgz?cjc=xhyiho7</a>
2	II BBA	3 <sup>rd</sup> SEM	FINANCIAL MANAGEMENT	<a href="https://classroom.google.com/c/NjE1MTk3OTQ3NjU2?cjc=r5j7eif">https://classroom.google.com/c/NjE1MTk3OTQ3NjU2?cjc=r5j7eif</a>
3	III BBA	5 <sup>th</sup> SEM	ADVERTISEMENT MANAGEMENT AND SALES PROMOTION	<a href="https://classroom.google.com/c/NTIzMDI5NDE4Njg5?cjc=e5rhwbv">https://classroom.google.com/c/NTIzMDI5NDE4Njg5?cjc=e5rhwbv</a>

  
**COURSE INSTRUCTOR**  
**Dr. H-DIVYAA**



**HOD SIGNATURE**  
**Prof. Indira Mahalingam**, M.A., M.Phil., M.Com.  
 NET (MGT) Head -  
 Department of Business Administration (Shift-2)  
 Dharmamurthi Rao Bahadur Calavala Cunnam  
 Chetty's Hindu College,  
 Pattabiram, Chennai - 600 072.

12:36

1st BBA - POM  
shift -1 Ms.Divyaa

Share with your class...

**Madhu P**  
Oct 18

Responsibilities of business

1 attachment

Add class comment

**Lekha Shree**  
Oct 18

Environment protection

1 attachment

Add class comment

**S Naviya**  
Oct 18

Values in business ethics

Stream    Classwork    People

12:37

Class settings    Save

### About

Title  
1st BBA - POM

Description

Section  
shift -1 Ms.Divyaa

Room

Subject  
Principles of Management

### General

Student invite settings

Class code: xhyiho7

Invite link:  
<https://classroom.google.com/c/NJE1MTk3ND...>

Manage Meet link

Classroom Meet link  
Classroom Meet links offer added safety features



**Prof.Indhra M Mandey** MBA, M.Phil., M Com.,  
NET(MGT) Head -  
Department of Business Administration (Shift 2)  
Dharmamurthi Rao Bahadur Calavala Cunnna  
Chetty's Hindu College,  
Pattabiram, Chennai - 600 072.

12:35

4G LTE

# Google Classroom

**IIIrd BBA - AMSP**  
Shift-1 Ms. Divyaa  
58 students

**IIInd BBA - FM**  
Shift-1 Ms. Divyaa  
65 students

**Ist BBA - POM**  
Shift-1 Ms. Divyaa  
62 students



12:36

4G LTE

Add class comment



**New material: Unit-5 notes**  
Oct 15

Add class comment



**New material: Unit -5 Business Ethics**  
Oct 11

Add class comment



**New material: Unit - 4 notes**  
Sep 26

Add class comment



**New material: Unit-3 continues notes of previous topics**  
Sep 19

Add class comment



**New material: Unit 3 final notes**  
Aug 30

Add class comment



**New material: Unit -3 notes**  
Aug 26

Stream

Classwork

People



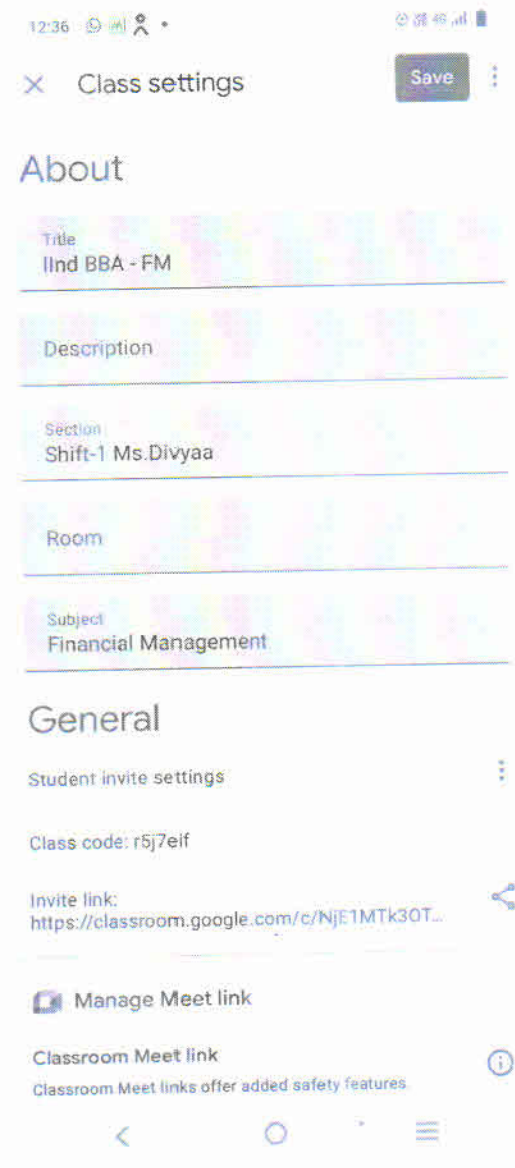
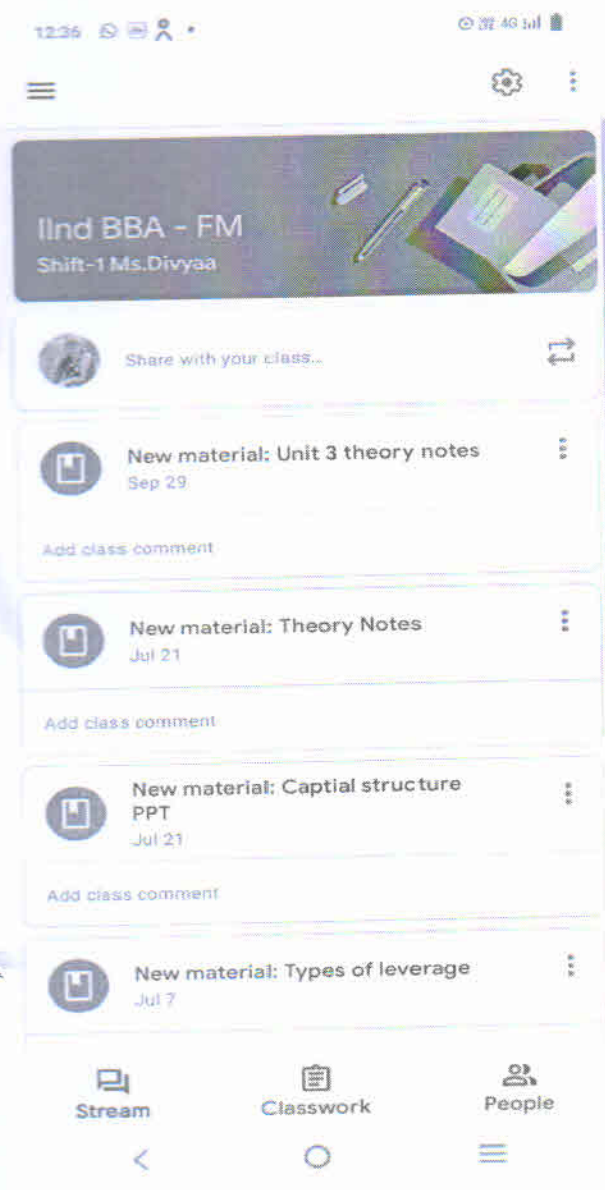

*[Handwritten Signature]*

Prof. Indhira M. Mandey MBA, M.Phil., M.Com.,  
NET/MGT Head -  
Department of Business Administration (Shift 2)  
Dharmamurthi Rao Bahadur Calavala Cunnan  
Chetty's Hindu College,  
Pattabiram, Chennai - 600 072.

12:35 4G

Illrd BBA -AMSP  
Shift-1 Ms.Divyaa

Share with your class...

**New material: Positive social effects**  
Oct 10

Add class comment

**New material: Negative social effects of advertising**  
Oct 10

Add class comment

**New material: Positive and negative economic advertising**  
Oct 5

Add class comment

**New material: Principles of ethics**  
Oct 1

Add class comment

Stream   Classwork   People

12:35 4G

Class settings   Save

### About

Title  
Illrd BBA -AMSP

Description

Section  
Shift-1 Ms.Divyaa

Room

Subject  
Advertising Management and sales promotion

### General

Student invite settings

Class code: e5rhwbY

Invite link:  
<https://classroom.google.com/c/NTIzMDI5ND...>

Manage Meet link

Classroom Meet link

**DRBCCC HINDU COLLEGE**  
**DEPARTMENT OF BUSINESS ADMINISTRATION SHIFT-II**  
**E-Learning Resources (ODD SEM)**  
**Dr. A. Kamalakannan**

**2023-2024**

S.NO	YEAR	SEMESTER	SUBJECT	RESOURCES
1	II BBA	3 <sup>rd</sup> SEM	COMPUTER APPLICATION IN BUSINESS OPERATION	<a href="https://classroom.google.com/c/NjMxOTgzNjI2NzYz?cjc=i32y44t">https://classroom.google.com/c/NjMxOTgzNjI2NzYz?cjc=i32y44t</a>
2	III BBA	5 <sup>th</sup> SEM	MANAGEMENT	<a href="https://classroom.google.com/c/NjMxOTgyMjEwNjY2?cjc=imbka5v">https://classroom.google.com/c/NjMxOTgyMjEwNjY2?cjc=imbka5v</a>
3	II BBM	3 <sup>rd</sup> SEM	MARKETING OF BANKING SERVICE	<a href="https://classroom.google.com/c/NjMyMjMwNzY4MDky?cjc=mqqyted">https://classroom.google.com/c/NjMyMjMwNzY4MDky?cjc=mqqyted</a>

*[Signature]*  
**COURSE INSTRUCTOR**  
**Dr - H - D S W A A**



*[Signature]*  
**PRINCIPAL,**  
**DHARMAMURTHI RAO BAHADUR CALAYALA CUNNAN**  
**CHETTY'S HINDU COLLEGE**  
**DHARMAMURTHI NAGAR, PATTABIRAM,**  
**CHENNAI - 600 072.**

*[Signature]*  
**HOD SIGNATURE**

**Prof. Indhra M Mandeey MBA..M.Phil., M Com.,**  
**NET(MGT) Head -**  
**Department of Business Administration (Shift 2)**  
**Dharmamurthi Rao Bahadur Calayala Cunnan**

☰ ⚙️ ⋮

II BBA (CAB)

Share with your class...

**KAMALAKANNAN A**  
13:54

II\_BBA\_CAB\_Notes-1

1 attachment

Add class comment

**New material:**  
II\_BBA\_CBA\_EDJ\_Notes  
12:51

Add class comment

Stream    Classwork    People

10:59 | 0.1KB/s

Class settings Save

### About

**Title**  
II BBA (CAB)

**Description**

**Section**

**Room**

**Subject**  
Computer Application in Business

### General

Student invitation settings

Class code: i32y44t

Invitation link:  
<https://classroom.google.com/c/NjMxOTgzNjI...>

Manage Meet link

Classroom Meet link  
*Classroom Meet links offer added safety features.*



Prof. Indhira M Mandey MBA, M.Phil., M.Com.,  
NET/MGT Head -  
Department of Business Administration (Shift 2)  
Dharmamurthi Rao Bahadur Calavaia Cunnari  
Chetty's Hindu College,  
Pattabiram, Chennai - 600 072.

16:59 | 19.4KB/s

Class settings Save

## About

Title  
III BBA (OM)

Description

Section

Room

Subject  
Operations Management

## General

Student invitation settings

Class code: imbka5v

Invitation link:  
<https://classroom.google.com/c/NjMxOTgyMj...>

Manage Meet link

Classroom Meet link  
Classroom Meet links offer added safety features.

Stream    Classwork    People

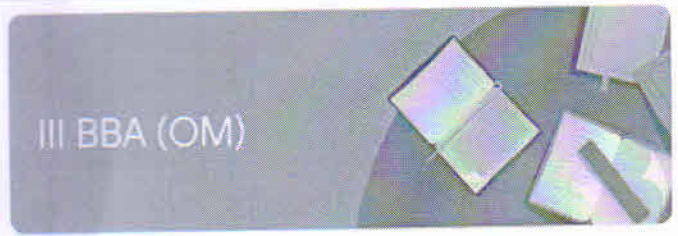

Share with your class...

KAMALAKANNAN A  
12:54

OM\_Book\_Material\_reference

1 attachment

Add class comment

KAMALAKANNAN A  
12:53

III\_BBA\_OM Notes

1 attachment

Add class comment



*G. Kalinmarai*

PRINCIPAL,  
DHARMAMURTHI RAO BAHADUR CALAVALA CUNNAN  
CHETTY'S HINDU COLLEGE  
DHARMAMURTHI NEEDAR, PATTABIRAM,  
CHENNAI - 600 072.

*Indhra M Mandey*

Prof. Indhra M Mandey MBA, M.Phil., M.Com.  
NET(MGT) Head -  
Department of Business Administration (Shift 2)  
Dharmamurthi Rao Bahadur Calavala Cunnan  
Chetty's Hindu College,  
Pattabiram, Chennai - 600 072.

(Even Sem)

**DRBCCC HINDU COLLEGE**

**DEPARTMENT OF BUSINESS ADMINISTRATION SHIFT-II**

**E-Learning Resources (EVEN SEM)**

**Prof. Indhra M Mandey**

**2023-2024**

S.NO	YEAR	SEMESTER	SUBJECT	RESOURCES
1	II BBA	4 <sup>th</sup> SEM	BUSINESS REGULATORY FRAMEWORK	<a href="https://classroom.google.com/c/NjQ2MjgxdY2NjM3?cjc=16x235d">https://classroom.google.com/c/NjQ2MjgxdY2NjM3?cjc=16x235d</a>
2	III BBA	6 <sup>th</sup> SEM	CUSTOMER RELATIONSHIP MANAGEMENT	<a href="https://classroom.google.com/c/NjQ2MjgxdY2NjM3?cjc=oolzlnq">https://classroom.google.com/c/NjQ2MjgxdY2NjM3?cjc=oolzlnq</a>

**COURSE INSTRUCTOR**

**HOD SIGNATURE**

**Prof. Indhra M Mandey MBA, M.Phil., M.Com.**

NET(MGT) Head -

Department of Business Administration (Shift II)  
Dharmamuthi Rao Bahadur Calavala Cunnah  
Chetty's Hindu College.

**Pattabiram, Chennai - 600 072.**

Prof. Indhira M Mandey

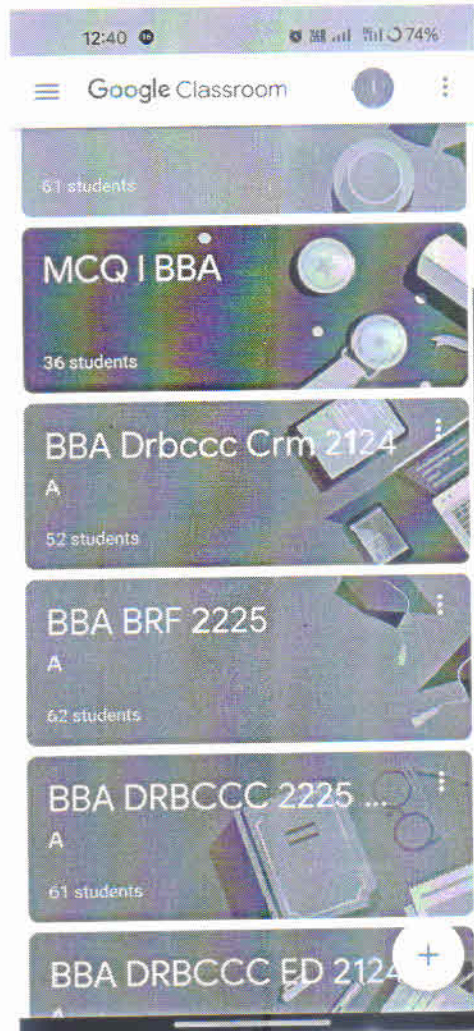
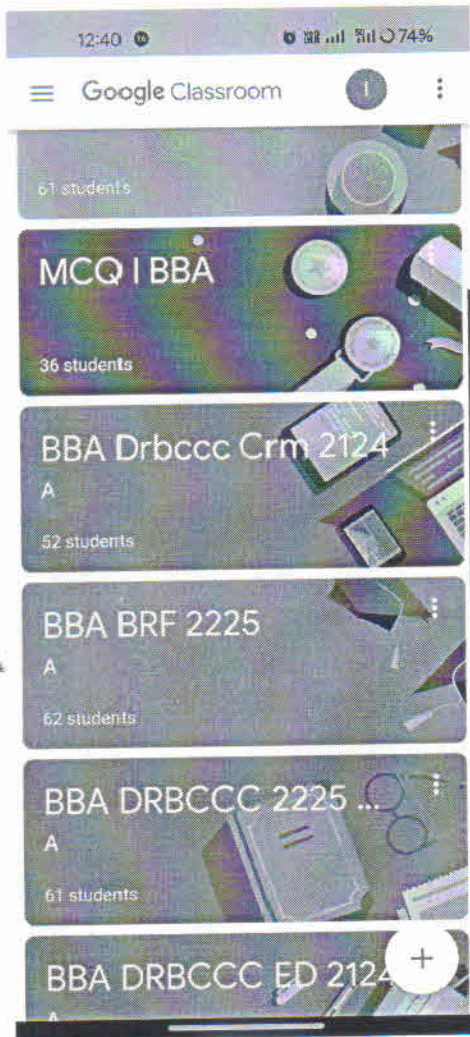

*Indhira*  
Prof. Indhira M Mandey M.Phil. M.Com.  
Director, P. G. Arts & Commerce College, Shift 2  
B. S. P. ...

**DRBCCC HINDU COLLEGE**  
**DEPARTMENT OF BUSINESS ADMINISTRATION SHIFT-II**  
**E-Learning Resources (EVEN SEM)**  
**Dr. B. Kalaiyasarani**

**2023-2024**

S.NO	YEAR	SEMESTER	SUBJECT	RESOURCES
1	I BBA	2 <sup>nd</sup> SEM	MANAGERIAL SKILLS DEVELOPEMENT	<a href="https://classroom.google.com/c/NjUwOTM4NTcwODI2?cjc=yukfvpv">https://classroom.google.com/c/NjUwOTM4NTcwODI2?cjc=yukfvpv</a>
2	II BBA	4 <sup>th</sup> SEM	HUMAN RESOURCE MANAGEMENT	<a href="https://classroom.google.com/c/NjI3ODDA2NTUzZmJmZz?cjc=ac2zc34">https://classroom.google.com/c/NjI3ODDA2NTUzZmJmZz?cjc=ac2zc34</a>
3	III BBA	6 <sup>th</sup> SEM	SERVICES MARKETING	<a href="https://classroom.google.com/c/NjUwNDYzZmZzOTU1?cjc=f5ljpjx">https://classroom.google.com/c/NjUwNDYzZmZzOTU1?cjc=f5ljpjx</a>

*B. Kalaiyasarani*  
**COURSE INSTRUCTOR**

**HOD-SIGNATURE**

**Prof.Indhira M Mandey MBA, M.Phil., M.Com**  
 NET(MGT) Head,  
 Department of Business Administration (Shift-II)  
 Dharmamurthi Rao Bahadur Calavala College,  
 Chetty's Hindu College,  
 Pattabiram, Chennai - 600 072.

Dr. B. Kalaiyarasaran

12:30

... [Icons] 4G VoLTE [Battery]

☰ Google Classro...



I BBA - Managerial Skill... ⋮

A

31 students

II BBA 2022-25 ⋮

A

66 students

III BBA 2021-24 ⋮

A

51 students

I BBA - (EM) 23-24



Prof. Indira...  
Department of...  
Dharmapuri

<b>DRBCCC HINDU COLLEGE</b>				
<b>DEPARTMENT OF BUSINESS ADMINISTRATION SHIFT-II</b>				
<b>E-Learning Resources (EVEN SEM)</b>				
<b>Dr. H. Divyaa</b>				
<b>2023-2024</b>				
S.NO	YEAR	SEMESTER	SUBJECT	RESOURCES
1	I BBA	2 <sup>nd</sup> SEM	ACCOUNTING FOR MANAGERS – II	<a href="https://classroom.google.com/c/NjUxMDM0MTY5OTES?cjc=yw3uuoy">https://classroom.google.com/c/NjUxMDM0MTY5OTES?cjc=yw3uuoy</a>
2	II BBA	4 <sup>th</sup> SEM	MANAGEMENT INFORMATION SYSTEM	<a href="https://classroom.google.com/c/NjQ5MjgwOTMwNDE0?cjc=7hxqjev">https://classroom.google.com/c/NjQ5MjgwOTMwNDE0?cjc=7hxqjev</a>
3	III BBA	6 <sup>th</sup> SEM	BUSINESS ENVIRONMENT	<a href="https://classroom.google.com/c/NjQ2MzUxNjgwNzly?cjc=e7dlc3b">https://classroom.google.com/c/NjQ2MzUxNjgwNzly?cjc=e7dlc3b</a>

  
COURSE INSTRUCTOR

**HOD SIGNATURE**

**Prof. Vidhya M Mandey MBA, M.Phil., M.Com**

NET(MGT) Head -

Department of Business Administration  
Dhanamurthi Rao Bahadur Calavala Cultural

Chetty's Hindu College,

Rattalasa, Chennarayana

**1st BBA AFM-II (2023-24)**  
 Shift -I Dr.H.Divyaa  
 45 students

**2nd BBA - MIS & PE (SS)**  
 Shift-I Dr.H.Divyaa  
 66 students

**3rd BBA - BE (2023- 24)**  
 Shift-1 Dr.H.Divyaa  
 58 students

*[Handwritten signature]*

Prof. Indira M. Mandey Urs M.Phil. M.Com.  
 Department of Commerce  
 Dharmamurthi Rao Bahadur Calavala Cunnan  
 Chetty's Hindu College  
 Dharmamurthi Nagar, Pattabiram,  
 Chennai - 600 072.



*G. Kalinayagi*

PRINCIPAL,  
 DHARMAMURTHI RAO BAHADUR CALAVALA CUNNAN  
 CHETTY'S HINDU COLLEGE  
 DHARMAMURTHI NAGAR, PATTABIRAM,  
 CHENNAI - 600 072.



<b>DRBCCC HINDU COLLEGE</b>				
<b>DEPARTMENT OF BUSINESS ADMINISTRATION SHIFT-II</b>				
<b>E-Learning Resources (EVEN SEM)</b>				
<b>Prof. P. Lavanya</b>				
<b>2023-2024</b>				
S.NO	YEAR	SEMESTER	SUBJECT	RESOURCES
1	II BBA	2 <sup>nd</sup> SEM	MARKETING MANAGEMENT	<a href="https://classroom.google.com/c/NjQ2NDU2NzE5NTEx?cjc=jhxvavg">https://classroom.google.com/c/NjQ2NDU2NzE5NTEx?cjc=jhxvavg</a>
2	III BBA	4 <sup>th</sup> SEM	FINANCIAL SERVICE	<a href="https://classroom.google.com/c/NjQ2NDU4MDY0ODIx?cjc=pcuqjvo">https://classroom.google.com/c/NjQ2NDU4MDY0ODIx?cjc=pcuqjvo</a>
3	II BBM	6 <sup>th</sup> SEM	BUSINESS TAXATION	<a href="https://classroom.google.com/c/NjQ2NDU3OTM0OTE2?cjc=myt2pnu">https://classroom.google.com/c/NjQ2NDU3OTM0OTE2?cjc=myt2pnu</a>

  
COURSE INSTRUCTOR

  
HOD SIGNATURE  
Prof. Indira M Mandey MBA, M.Phil., M.Com  
NET(MGT) Head  
Department of Business Administration (Shift 2)  
Dharmajurthi Rao Bahadur Calavala Cunnan  
Chetty's Hindu College,  
Puttur, Chittoor - 522 012

III BBA - BT

47 students

II BBA - FS

69 students

I BBA - MM

39 students

Prof. Indira M. Manjappa, Ph.D., Com.  
Dean, ...  
Director, ...  
...

2.3.2

(ODD SEM)

DRBCCC HINDU COLLEGE  
DEPARTMENT OF BUSINESS ADMINISTRATION SHIFT-II  
E-Learning Resources (ODD SEM)  
Prof. Indhra M Mandey

2023-2024

S.NO	YEAR	SEMESTER	SUBJECT	RESOURCES
1	II BBA	3 <sup>rd</sup> SEM	Marketing Management	<a href="https://classroom.google.com/c/NjE1MTk3NzgwNjU4/p/NjE1NjE3MDIxMzly/details">https://classroom.google.com/c/NjE1MTk3NzgwNjU4/p/NjE1NjE3MDIxMzly/details</a>
2	III BBA	5 <sup>th</sup> SEM	Materials Management	<a href="https://classroom.google.com/c/NjE1MTk0ODc2MTcy?cjc=no577vm">https://classroom.google.com/c/NjE1MTk0ODc2MTcy?cjc=no577vm</a>
3	III BBA	5 <sup>th</sup> SEM	Entrepreneurial Development	<a href="https://classroom.google.com/c/NjE1MTk0ODQ3MDQ5?cjc=4lr2cbx">https://classroom.google.com/c/NjE1MTk0ODQ3MDQ5?cjc=4lr2cbx</a>



COURSE INSTRUCTOR



HOD SIGNATURE

Prof. Indhra M Mandey MBA, M.Phil., M.Com.,  
NET(MGT) Head -

Department of Business Administration (Shift-2)  
Chetty's Hindu College,  
Pattabiram, Chennai - 600 072

16:15

32%

Class settings

Save

## About

Title  
BBA DRBCCC 2225 MKT MGT

Description

Section  
A

Room  
3

Subject  
Marketing Management

## General

Student invitation settings

Class code: tmpptri

Invitation link:  
<https://classroom.google.com/c/NjE...>

Manage Meet link

16:16

31%



BBA DRBCCC 2225 MKT ...  
A

Share with your class...

Indhra Mandey  
2 Oct

Question Bank Marketing

1 attachment

Add class comment

Indhra Mandey  
31 Jul

Module 2

1 attachment

Add class comment

Stream

Classwork

People

Prof. Indhra M. Mandey MBA, M.Phil., M.Com.,  
NET(MGT) Head -  
Department of Business Administration (Shift 2)  
Dharmamurthi Rao Bahadur Calavala Cunnan  
Chetty's Hindu College,  
Pattabiram, Chennai - 600 072.

16:13

33%

Class settings

Save

Title

BBA DRBCCC ED 2124

Description

Section

A

Room

2

Subject

Entrepreneurial Development

## General

Student invitation settings

Class code: 4lr2cbx

Invitation link:

<https://classroom.google.com/c/NjE...>

Manage Meet link

Classroom Meet link

Classroom Meet links offer added safety featu

16:16

31%



Indhra Mandey

14 Jul

Module 2

1 attachment

Add class comment



Indhra Mandey

14 Jul

Module 2 blended learning material

1 attachment

Add class comment



New assignment:

Simulation

4 Jul

Add class comment



Indhra Mandey

3 Jul

Marketing notes

1 attachment

Add class comment



Stream



Classwork



People

**Prof. Indhra M. Mandey** MBA, M.Phil., M.Com.,  
NET(MGT) Head -  
Department of Business Administration (Shift 2)  
Dharmamurthi Rao Bahadur Calavala Cunnan  
Chetty's Hindu College,  
Pattabiram, Chennai - 600 072.

16:15

32%

Class settings

Save

# About

Title  
BBA DRBCCC 2124 MAT

Description

Section  
A

Room  
1

Subject  
Materials Management

# General

Student invitation settings

Class code: no577vm

Invitation link:  
<https://classroom.google.com/c/NjE...>

Manage Meet link

12:36

46%

Add class comment

New material: Unit-5 notes  
Oct 15

Add class comment

New material: Unit -5 Business Ethics  
Oct 11

Add class comment

New material: Unit - 4 notes  
Sep 26

Add class comment

New material: Unit-3 continues notes of previous topics  
Sep 19

Add class comment

New material: Unit 3 final notes  
Aug 30

Add class comment

New material: Unit -3 notes

Stream

Classwork

People



*G. Kalinraaj*

PRINCIPAL,  
DHARMAMURTHI RAO BAHADUR CALAVALA CUNNAN  
CHETTY'S HINDU COLLEGE  
DHARMAMURTHI NAGAR, PATTABIRAM,  
CHENNAI - 600 072.

*[Signature]*

Prof. Indra M Mandey MBA, M.Phil., M.Com.,  
NET(MGT) Head -  
Department of Business Administration (Shift 2)  
Dharmamurthi Rao Bahadur Calavala Cunnan  
Chetty's Hindu College,  
Pattabiram, Chennai - 600 072.

2.3.2

(9)

### Google Classroom

Stream    Classwork    People    Grades

**Java for 23-24 AI class**

Meet    Generate link

Class code

Announce something to your class

bsc artificial intelligence posted a new assignment: **Overriding Methods**  
Mar 16 (Edited Mar 16)

<https://classroom.google.com/c/NjU3MzlxODg2MzEy?cjc=7zvwlc3>

### Google Forms

Classwork    People    Grades

bsc artificial intelligence posted a new assignment: **Classes and Objects**    Due Feb 4

Posted Feb 2 (Edited Feb 2)

0	20	29
Turned in	Assigned	Graded

Classes - Objects - Cons...  
Google Forms

Add class comment...

bsc artificial intelligence posted a new assignment: **OOPs Concepts - Quiz 2**    Due Jan 27

Posted Jan 25

0	24	25
---	----	----

<https://classroom.google.com/c/NjU3MzlxODg2MzEy/a/NjQ4MTAxMzk5Mjg2/details>

*Dr. U. Sri Sath*  
 Dharmamurthi Rao Bahadur  
 Calavala Cunnan Chetty's Hindu College (Smt. S. S. S.),  
 Dharmamurthi Nagar,  
 Pattabiram, Chennai-600072.

2032

PPT : <https://classroom.google.com/c/NjU3MzlxODg2MzEy/m/NjY3NTcwMjIwNDI4/details>

Classwork People Grades

---

bsc artificial intelligence posted a new material: Adapter Class

Posted Mar 6

 Adapter Classes.pptx  
PowerPoint

Add class comment...

bsc artificial intelligence posted a new material: Java notes (This and super keyword)

Posted Feb 21

*Dr. U. Sri Smath*

Dharmamurthi Rao Bahadur  
Calavala Cunnan Chetty's Hindu Collega (Shift  
Dharmamurthi Nagar,  
Pattabiram, Chennai-600072.

**DHARMAMURTHI RAO BAHADUR CALAVALA CUNNAN  
CHETTY'S HINDU COLLEGE**

**PATTTABIRAM, CHENNAI-600 072**

**DEPARTMENT OF B.SC COMPUTER SCIENCE WITH  
ARTIFICIAL INTELLIGENCE**



**ICT Tools Used for Teaching - Python, 2023**

**Submitted By**

**Dr.U. Urathal Alias Sri Swathiga**

**Head of the Department**

## Report on Varied ICT Tools Used for Teaching

**Introduction:** Information and Communication Technology (ICT) has revolutionized the field of education, providing diverse tools and platforms to enhance teaching and learning experiences. This report provides an overview of various ICT tools used for teaching, focusing on their impact and benefits in modern educational settings.

### 1. Learning Management Systems (LMS):

- **Examples:** Google Classroom.
- **Benefits:**
  - Centralized platform for course content delivery.
  - Enables online collaboration, discussion forums, and assignment submissions.
  - Streamlines grading and feedback processes.

### 2. Interactive Whiteboards:

- **Examples:** SMART Board, Promethean Board.
- **Benefits:**
  - Facilitates dynamic and interactive presentations.
  - Enhances engagement through touch-sensitive surfaces.
  - Enables real-time annotation and collaboration.

### 3. Video Conferencing Tools:

- **Examples:** Google Meet.
- **Benefits:**
  - Supports virtual classrooms and remote learning.
  - Facilitates live discussions, Q&A sessions, and collaborative projects.
  - Enhances accessibility for geographically dispersed students.

### 4. Online Assessment Tools:

- **Examples:** Kahoot!, Quizizz, Google Forms.
- **Benefits:**
  - Enables formative and summative assessments.
  - Immediate feedback to students and teachers.
  - Varied question formats for a comprehensive evaluation.

**Conclusion:** The integration of varied ICT tools in teaching has transformed traditional educational methods, providing educators with dynamic resources to cater to diverse learning styles and preferences. The continuous exploration and implementation of these tools

contribute to a more engaging, inclusive, and effective educational experience for both teachers and students.

This report highlights the importance of embracing ICT tools and leveraging their potential to create innovative and impactful teaching and learning environments. Ongoing professional development and adaptability are essential to maximizing the benefits of these tools in the ever-evolving landscape of education.

### Google Class Room Link:

<https://classroom.google.com/c/NTIzMTc4NTczMjAx?cjc=5n7vtxf>

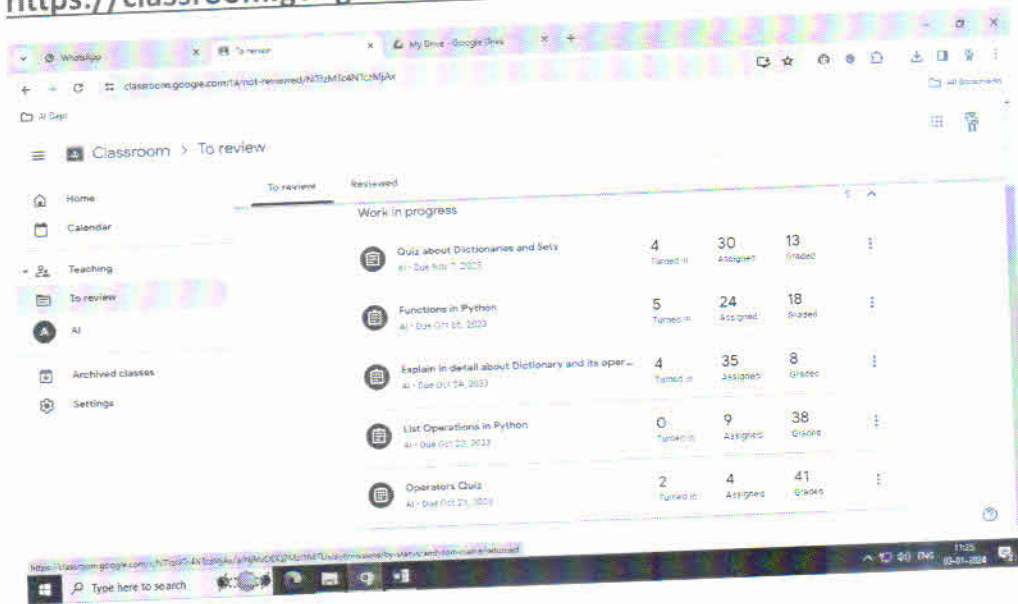

### Interactive White Board

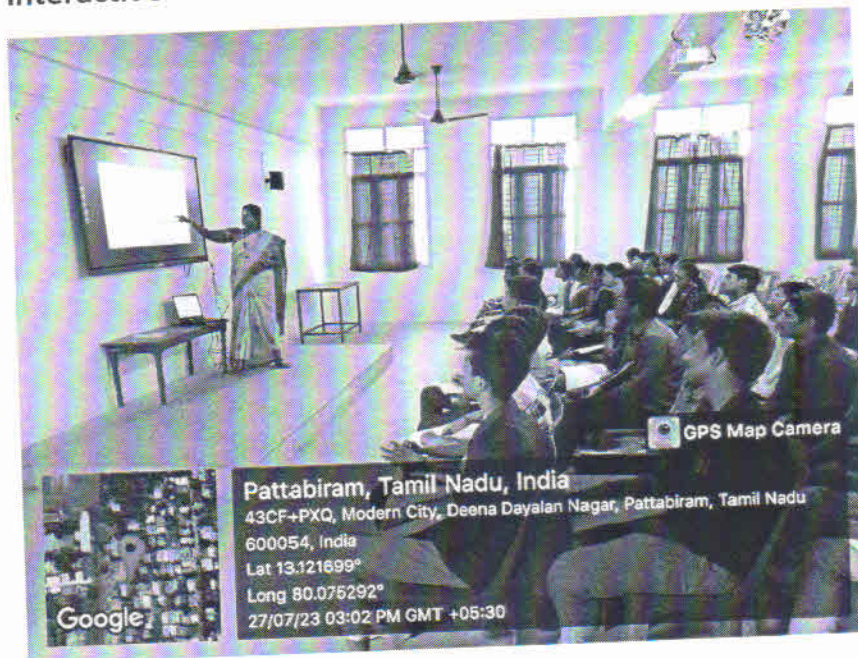

## White Board Class

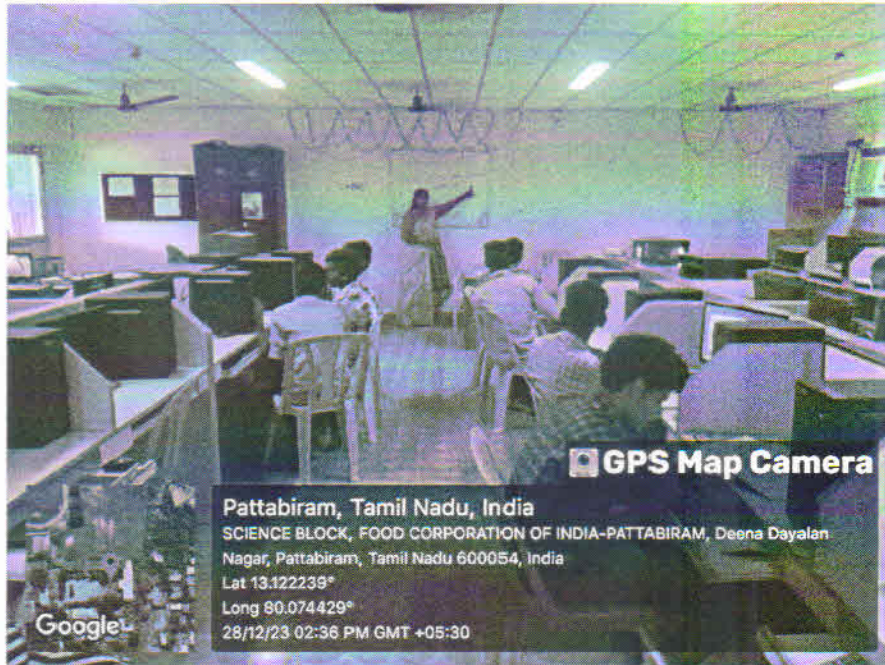

## Quizziz

Name	Value
Game Started On	Tue 18 Jul 2023,04:23 PM
Game Type	Homework
Class name(s)	AI
Participants	21
Total Attempts	21
Class Accuracy	76%
Game Ends On	Thu 20 Jul 2023,12:47 AM

**QUIZZZ**

Google Forms - <https://docs.google.com/forms/d/1v-CX50JxzeiOI8CMNb7V37Ev0XE8d7PaurxKjIHyeCE/edit#responses> 1/1

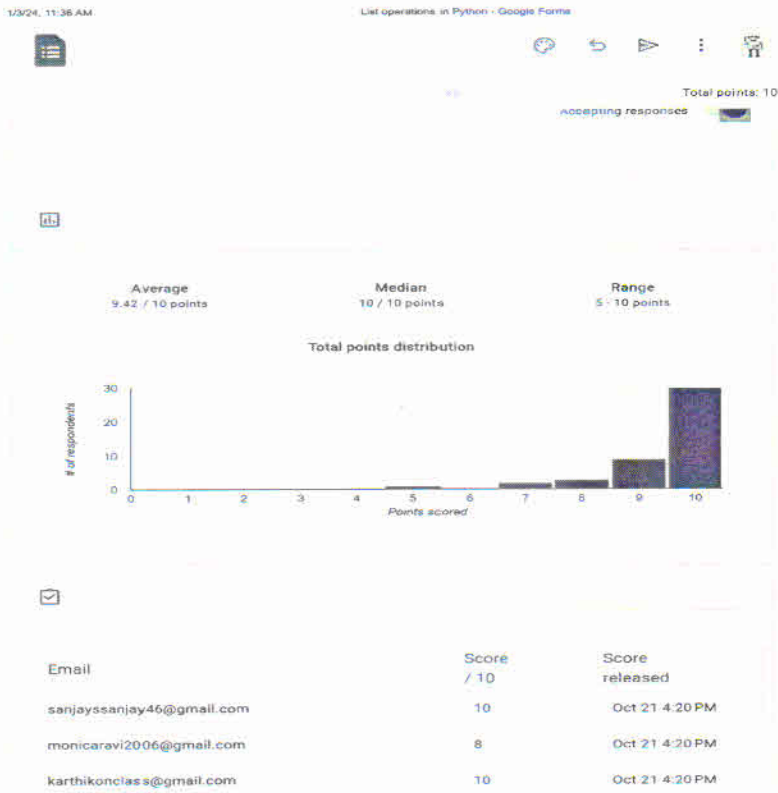

**Projector Class**



**Dharmamurthi Rao Bahadur**  
**Jalavaia Cunnan Chetty's Hindu College (Shift 2)**  
**Dharmamurthi Nagar,**  
**Pattabiram, Chennai-600072.**

*U. S. S. Smalt*  
**HOD**

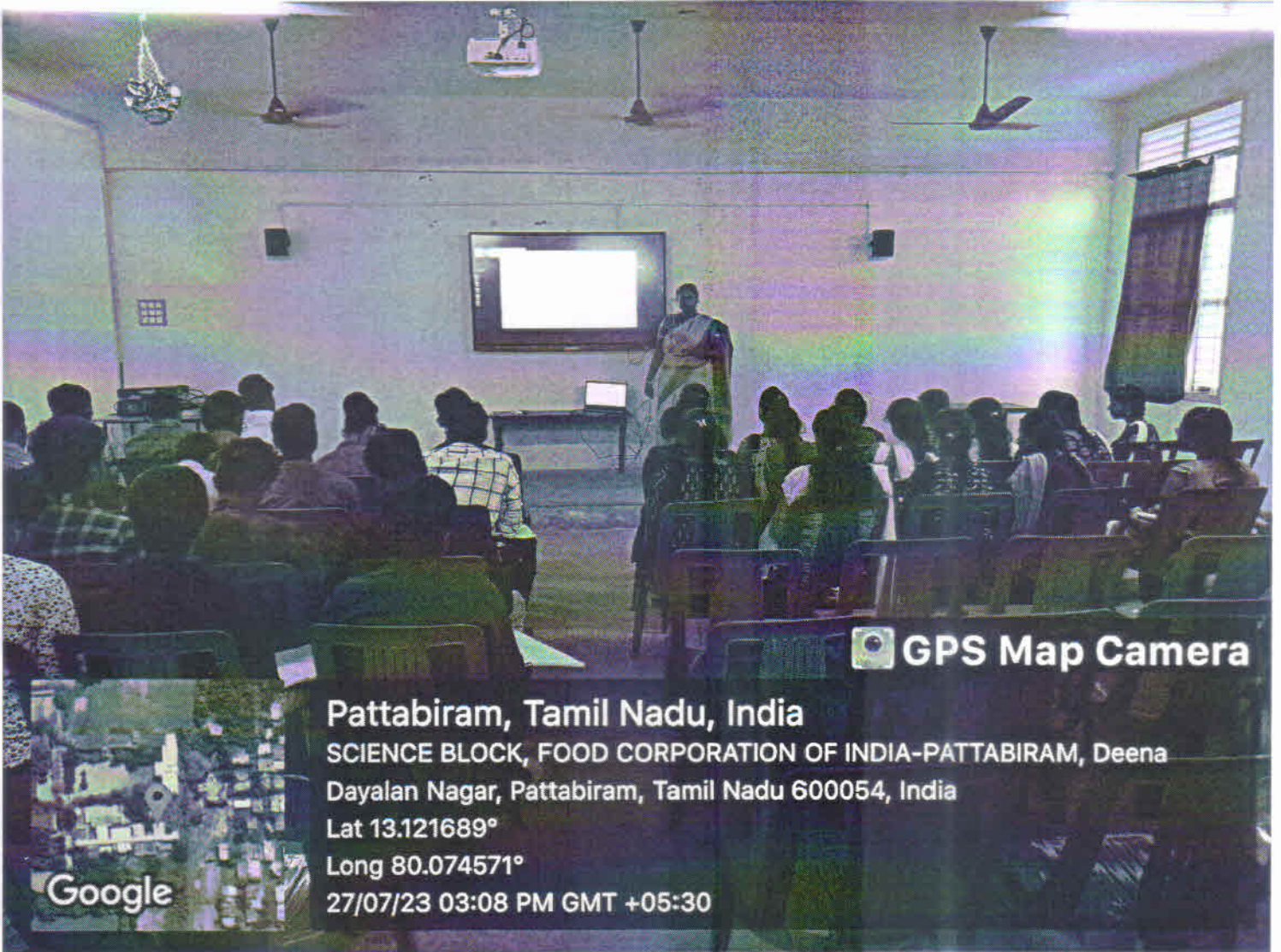

*D. U. Srinivasan*

Dharmamurthi Rao Bahadur  
Calavala Cunnan Chetty's Hindu College (Sri...  
Dharmamurthi Nagar,  
Pattabiram, Chennai-600072.

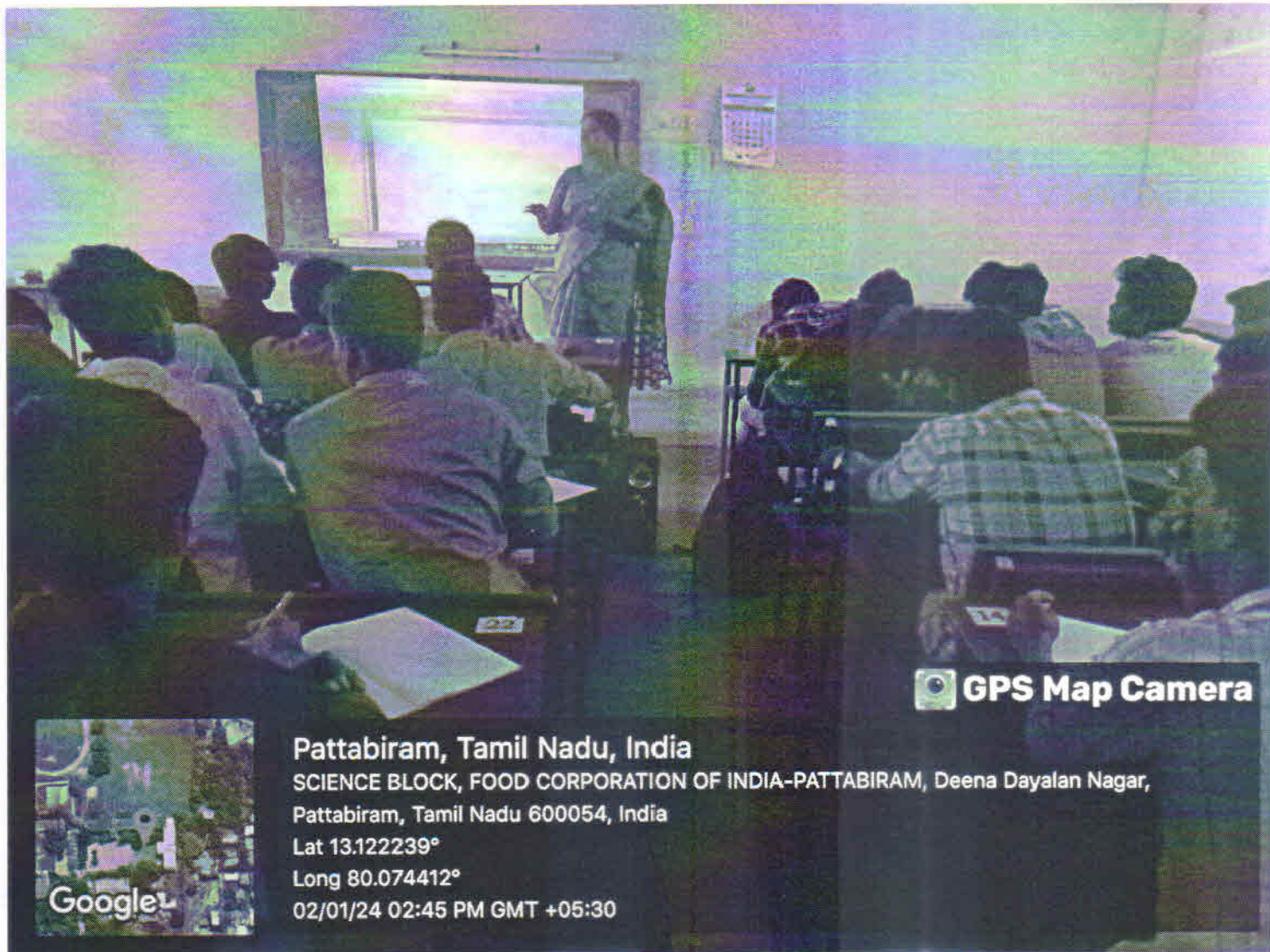

 **GPS Map Camera**

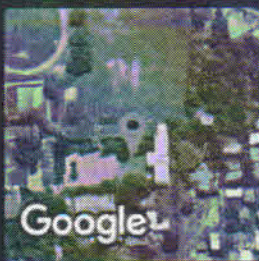

Google

**Pattabiram, Tamil Nadu, India**

SCIENCE BLOCK, FOOD CORPORATION OF INDIA-PATTABIRAM, Deena Dayalan Nagar,  
Pattabiram, Tamil Nadu 600054, India

Lat 13.122239°

Long 80.074412°

02/01/24 02:45 PM GMT +05:30

*Dr. U. Sri Smath*

Dharmamurthi Rao Bahadur  
Calavala Cunnan Chetty's Hindu College (SHIN 2)  
Dharmamurthi Nagar,  
Pattabiram, Chennai - 600072



*U. Sri Smath*  
**PRINCIPAL,**  
DHARMAMURTHI RAO BAHADUR CALAVALA CUNNAN-  
CHETTY'S HINDU COLLEGE  
DHARMAMURTHINAGAR, PATTABIRAM,  
CHENNAI - 600072.

2.3.2

Report

Frequency of ICT Tool Usage:

- Over 90% of staff reported using ICT tools on a daily basis.
- Approximately 80% of staff reported using projectors at least once a week for presentations, meetings, or training sessions.
- Google classroom ( Materials and links are shared)
- Email remains the most commonly used tool, followed by Microsoft Office Suite (Word, Excel, PowerPoint).

Projectors play a significant role in facilitating presentations, meetings, and training sessions within our organization. While staff members generally express satisfaction with their usage, there are notable challenges such as technical issues and lack of training on advanced functionalities. By addressing these challenges and implementing suggested improvements, the organization can maximize the effectiveness of projectors in supporting staff operations.

In addition to Information and Communication Technology (ICT) tools, projectors have become an integral part of modern workplaces, facilitating presentations, meetings, and training sessions.

Photos:

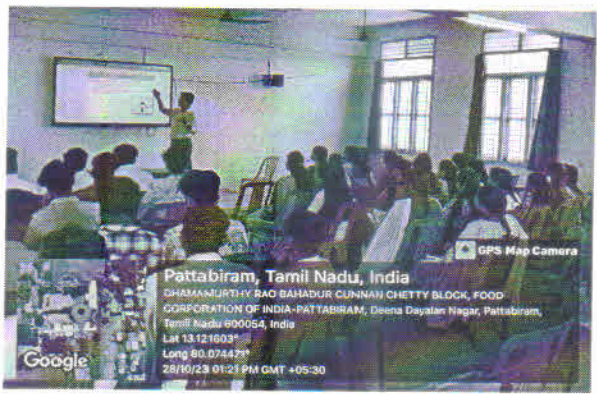
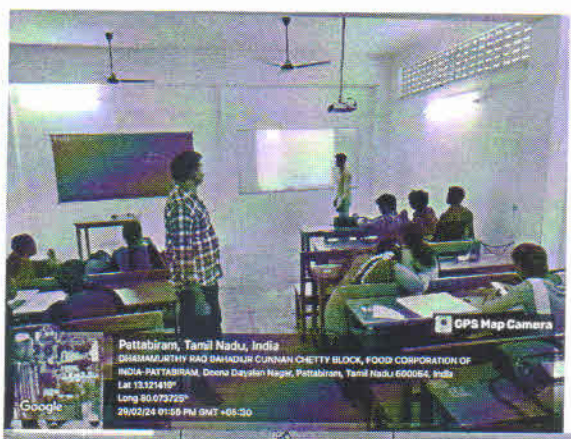



### II BSC COMPUTER S...

B



### Business Statistics

II B.com: C Sec



### R Programming Work...

GNANASEKAR KALAM



### Machine Learning for...

26- 31 July 2021

E&ICT Academy IIT-Guwahati



 Customize

# BBA. Statistics

 Announce something to your class



 Devi Devi  
Mar 9



M.Homalakshmi(22BA154)



M.Homalakshmi (2...  
PDF

 Add class comment...



 ABINAYA N  
Mar 9



N.ABINAYA

- 22BA170



IMG\_20240309\_13...  
PDF



Stream    Classwork    People    Grades



**Sandhya Sandhya**  
Mar 8



R.Sandhya  
22BA169



R.Sandhya 22BA169...  
PDF



Add class comment...



**Dharshini 22**  
Mar 8



P.Dharshini  
22BA148



P Dharshini 22BA14...  
PDF



Add class comment...



**Karthi K**  
Mar 8



K. Karthi 22BA115 OR Assignment



Drive file  
Unknown File



Add class comment...





Stream

Classwork

People

Grades

Oct 21, 2023

Ishwarya R posted a new material: 6  
Oct 21, 2023



Ishwarya R posted a new material: 5  
Oct 21, 2023



Ishwarya R posted a new material: 4  
Oct 21, 2023



Ishwarya R posted a new material: 3  
Oct 21, 2023



Ishwarya R posted a new material: 2  
Oct 21, 2023



Ishwarya R posted a new material: 1  
Oct 21, 2023



Ishwarya R posted a new material: Qp  
Oct 21, 2023 (Edited Oct 21, 2023)





2.3.2 Innovation Teaching  
Youtube channel Dept of ECS

7.2.1

← gopinath annamalai × 🔊 📺 ⋮

 Gopinath Annamalai  
646 subscribers · 184 videos  
SUBSCRIBE

Latest from Gopinath Annamalai

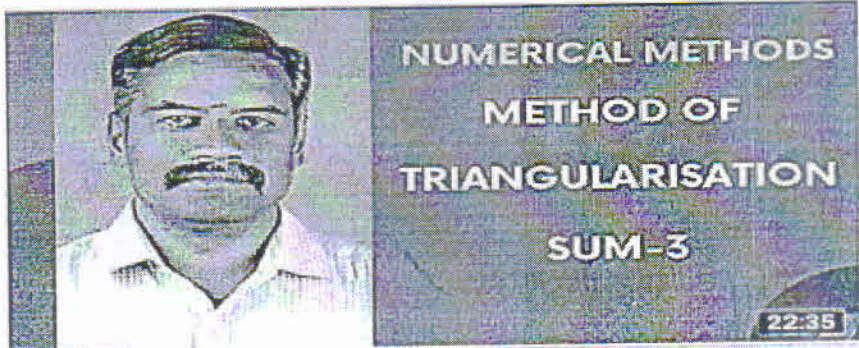
 NUMERICAL METHODS  
METHOD OF  
TRIANGULARISATION  
SUM-3  
22:35

 Method of Triangularisation-Sum-3  
Gopinath Annamalai · 24 views · 1 week ago

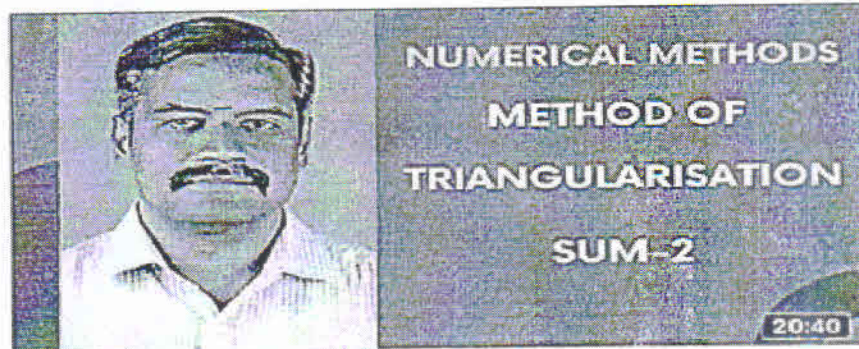
 NUMERICAL METHODS  
METHOD OF  
TRIANGULARISATION  
SUM-2  
20:40

Home Shorts + Subscriptions Library

  
Assistant Professor and Head  
Department of Electronics and  
Communication Science  
DRBCCC Hindu College  
Pattabiram, Chennai - 600 072.

# PPT



## 8085 - Simulator Program



*S. S. Srinivas*  
Assistant Professor and Head  
Department of Electronics and  
Communication Science  
DRBCCC Hindu College  
Pattabiram, Chennai - 600 072.

# Seminar

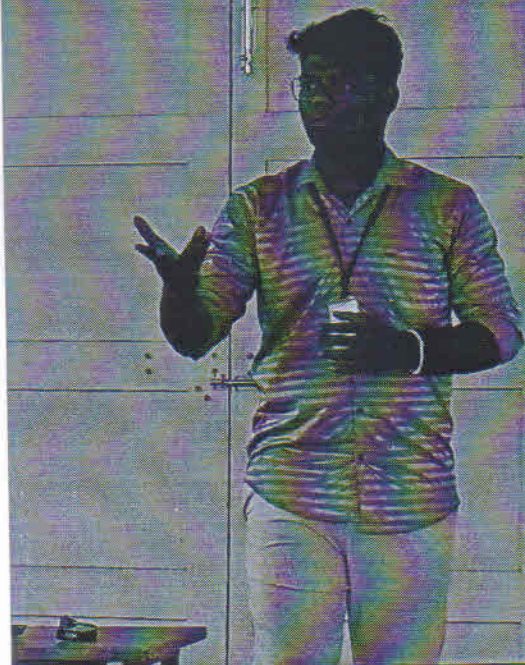

## FEATURES

- GPS extends the GSM Packet circuit switched data capabilities and makes the following services possible
- Web browsing and broadcasting
- "Always on" Internet access
- Multimedia messaging service (MMSC)
- Push-to-talk over cellular (PTT)
- Location based services and proximity - wireless village

 **GPS Map Camera**



**Pattabiram, Tamil Nadu, India**

43CG+HFV, Arjun Main Rd, Modern City, Deena Dayalan Nagar,

Pattabiram, Tamil Nadu 600054, India

Lat 13.121564°

Long 80.076715°

20/10/23 01:08 PM GMT +05:30

  
Assistant Professor  
Department of Electronics  
Communication Science  
**DRBCCC Hindu College**  
Pattabiram, Chennai - 600 072.

Smart Cam



GPS Map Camera



**Pattabiram, Tamil Nadu, India**  
SCIENCE BLOCK, FOOD CORPORATION OF INDIA-PATTABIRAM,  
Deena Dayalan Nagar, Pattabiram, Tamil Nadu 600054, India  
Lat 13.121996°  
Long 80.074597°  
27/07/23 04:49 PM GMT +05:30

*S. Srinivasan*  
Assistant Professor and Head  
Department of Electronics and  
Communication Science  
**DRBCCC Hindu College**  
Pattabiram, Chennai - 600 072.

8085 Simulator

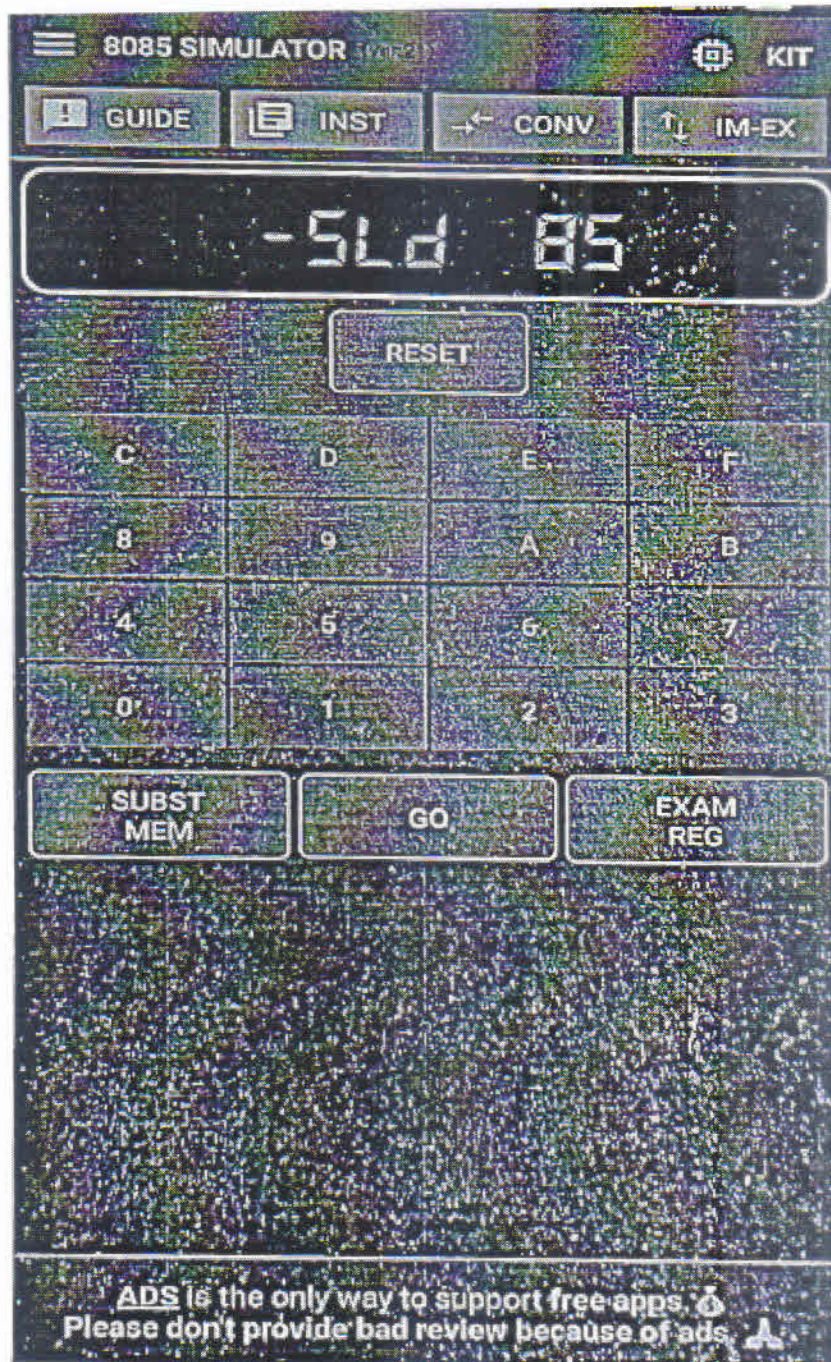

S. Srinivas  
Assistant Professor and Head  
Department of Electronics and  
Communication Science  
DRBCC Hindu College  
Pattabiram, Chennai - 600 072.

# Arduino Program

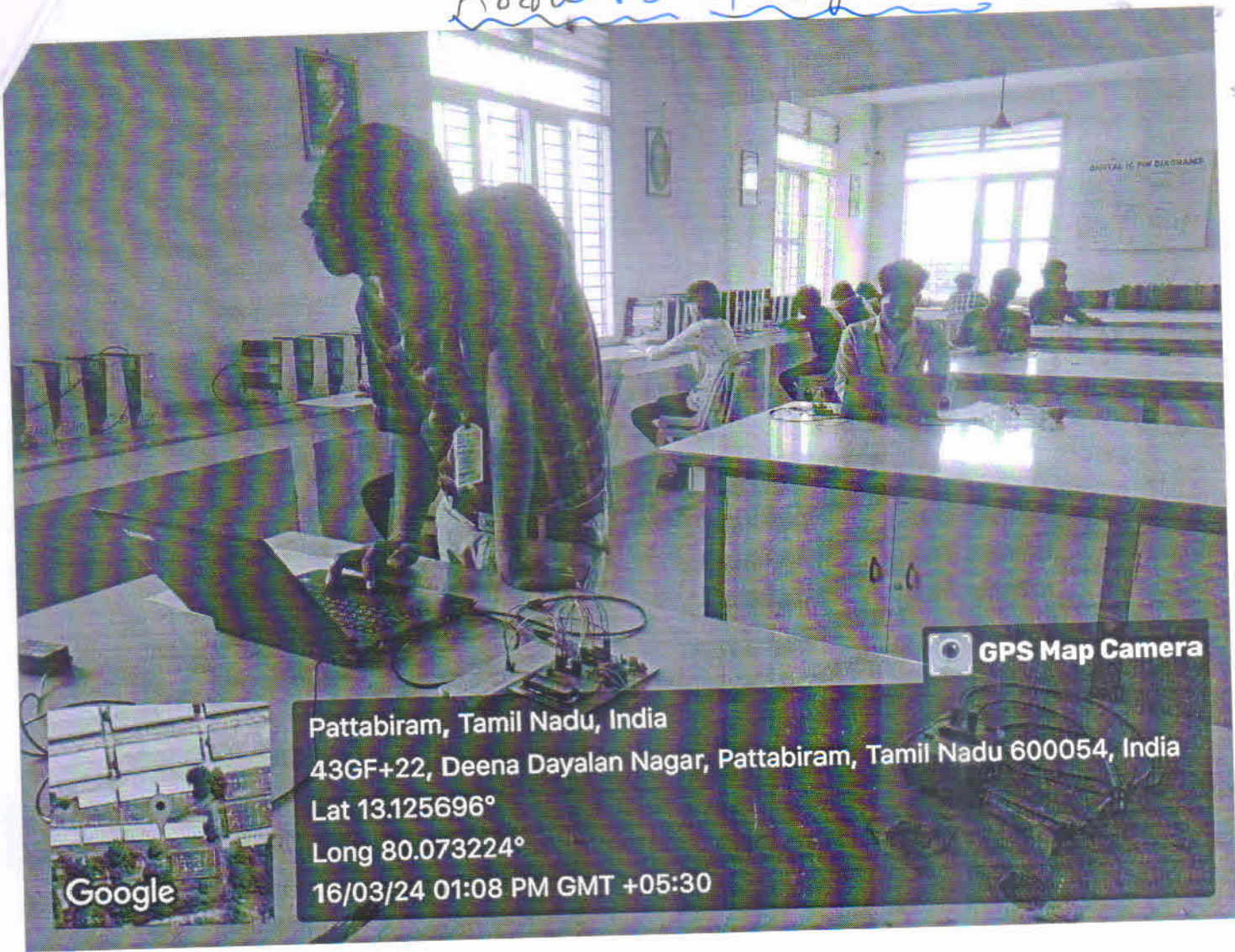

 **GPS Map Camera**

Pattabiram, Tamil Nadu, India  
43GF+22, Deena Dayalan Nagar, Pattabiram, Tamil Nadu 600054, India  
Lat 13.125696°  
Long 80.073224°  
16/03/24 01:08 PM GMT +05:30



  
Assistant Professor and Head  
Department of Electronics and  
Communication Science  
DRBCCC Hindu College  
Pattabiram, Chennai - 600 072.

  
PRINCIPAL,  
DHARMAMURTHI RAO BAHADUR CALAVALA CUNNAM  
CHETTY'S HINDU COLLEGE  
DHARMAMURTHI SWAMYAR, PATTABIRAM,  
CHENNAI - 600 072.





☰ Google Classroom



II B com  
A  
44 students

This course card features a background illustration of a coffee cup, a pie chart, and a laptop. The text on the card reads 'II B com', 'A', and '44 students'.

III B. Com  
C  
41 students

This course card features a background illustration of a laptop, a smartphone, and a tablet. The text on the card reads 'III B. Com', 'C', and '41 students'.

II M. Com  
PG  
22 students

This course card features a background illustration of two graduation caps. The text on the card reads 'II M. Com', 'PG', and '22 students'.

Marketing  
II B  
71 students

This course card features a background illustration of a book, a pair of glasses, and a pen. The text on the card reads 'Marketing', 'II B', and '71 students'.



II M. Com



Narmadha P



Pavi Nagaraj



Prakash E



Prasad Jeeva



Ruby Ruby



Sandhiya Sandy



Shri lakshmi



Siranjeevi R



Siva M



T yokesh



Stream



Classwork



People





# III.B.Com

A



Announce something to you...



Sivapriya S  
Yesterday



Good Evening Students,  
I have enclosed herewith UNIT 1  
notes for your reference. Kindly go  
through it.

Thank you..

 FM Unit 1.docx

Add class comment



Stream



Classwork



People



III.B.Com



# Teachers



Sivapriya S

# Students



Abinaya S



Amar Sheriff



Anbu Selvan



Archana Archana.P



Benzene



Bhuvana Raghu



Deepa



Stream



Classwork



People

*Principalsignatory*  
PRINCIPAL,  
DHARMAMURTHI RAO BAHADUR CALAVALA CUNNAN  
CHETTY'S HINDU COLLEGE  
DHARMAMURTHI NAGAR, PATTABIRAM,  
CHENNAI - 600 072.



C. K. K. S.  
Calavala Cunna Chetty's Hindu College (Shri 2)  
Dharmamurthi Nagar,  
Porichram, Chennai-60012



03/01/24 05:00 PM

Students Teaching Students Topic: I know why the caged bird sings by Maya Angelou

GPS Map Camera

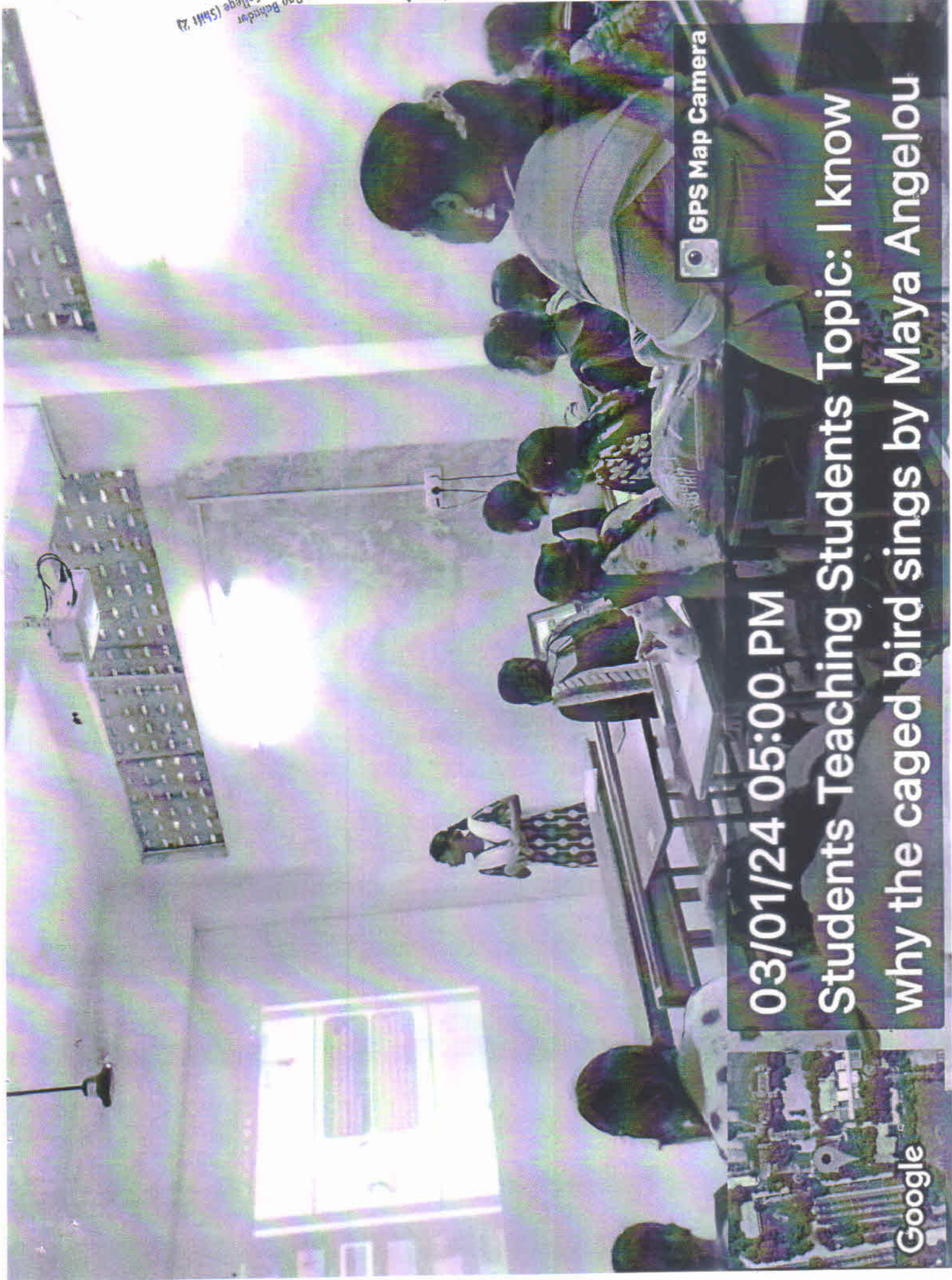

**DRBCCC Hindu College**  
**Department of English (Shift 2)**  
**ICT Tools and e-content committee (General English)**  
**MID-YEAR REPORT – AY 23-24**

Keeping in mind the ever-widening integration of technology in language teaching, the Department of English (Shift 2) under the able guidance and supervision of Dr. Karpagavalli, Associate Professor and Head of the Department of English, started implementing ICT tools, and creating e-content for the General English students of the department from this academic year. The project which started on a trial basis soon picked up the necessary momentum. A meeting was conducted with the Head of the Department to evolve and finalize a plan for the ICT/e-content development. The Minutes of the Meeting is posted below.

**Department of English (Shift 2)**  
**Minutes of the Meeting**  
**ICT Tools and e-content Committee**

Date - July 17, 2023 / Venue – Department of English (Shift 2) / Time 11 am

A department level meeting was convened by the Head of the Department of English (Shift 2) Dr. C Karpagavalli on July 17, 2023, at 11 am. The primary objective of the meeting was to discuss the implementation of the ICT enabled teaching in the English classrooms and the creation of e-content for teaching and learning purposes.

The following were the attendees:

1. Dr. C Karpagavalli- Head of the Department of English (Shift 2)
2. Prof. Premjith Mathew - Assistant Professor, Department of English
3. Prof. K Karthi - Assistant Professor, Department of English
4. Prof. R Dinesh Kumar - Assistant Professor, Department of English

The meeting discussed the following points in connection to the ICT tools and e-content development:

- The attendees of the meeting opined that the teaching fraternity should move away from the comfort zone of using traditional methods of teaching and embrace technology to engage the learner. There is the need for a paradigm shift in mind set of the teachers. Teachers should be encouraged to use MALL (Mobile Assisted Language Learning) in the classroom.
- It was decided to conduct a survey/ poll among the first-year students of DRBCCC Hindu college to gauge their response regarding ICT / e-content.
- The members agreed to create an online e-content club in the college adding all the first-year students in a WhatsApp group.

  
C. Karthi  
Associate Professor in English  
Department of English  
DRBCCC Hindu College (Shift 2)  
Pattabirum, Chennai-600072

- The attendees opined that a proposal with the infrastructural needs of the department (extra computer with printer and scanner), projectors in the classroom, along with a detailed proposal for a language lab should be prepared based on the survey. The same should be submitted to the Principal and the Director.
- It was decided in the meeting to plan for a workshop on ICT Tools for the teachers in the second week of August. The objective of the workshop is to enable teachers to familiarize with the necessary IT and e-content generation skills.
- It is imperative that teachers prepare e-content for their respective classes and share it in the department WhatsApp group for documentation purpose. It was suggested that every teacher create at least one e-content for their students.
- It was also decided that an MoU can be signed with a company or an organization specializing in e-content/ digital tools.

The following duties and responsibilities were discussed and approved by the Head of the Department:

- Prof. Karthi will take care of the e-content generation in the BA English classes by creating an exclusive online group.
- Prof. Premjith will work to create a WhatsApp group for all the first-year students and will focus on content generation for Part II English.
- Prof. Dinesh, apart from Naan Mudhalvan project will offer his assistance to both B.A English and Part II English WhatsApp groups.

The meeting ended at 11. 30 am.

#### ACTIVITIES:

A WhatsApp group was created in the month of July 2023 to publish the e-content created by the staff and students. Most of the content created were related to the First Year general English syllabus. The common format used was digital posters. Assessment using Kahoot was also conducted through the WhatsApp group along with some in-app based quizzes and polls. Students who scored high marks were given cash awards and books as prizes. A WhatsApp group was also created for the second year General English students. (Science students) with the approval of the Head of the Department. Some of the e-content created (sample posters) can be accessed by scanning this QR code.



Sample report of the Kahoot Quizzes conducted for the students is given below:

Know Your State - The English Hub - Weekend Quiz			
Played on	26 Aug 2023		
Hosted by	Premjith7723		
Played with	100 players		
Played	10 of 10		
Overall Performance			
Total correct answers (%)	53.80%		
Total incorrect answers (%)	46.20%		
Average score (points)	4418.87 points		
Feedback			
Number of responses	0		
How fun was it? (out of 5)	0.00 out of 5		
Did you learn something?	0.00% Yes	0.00% No	
Do you recommend it?	0.00% Yes	0.00% No	
How do you feel?	<input checked="" type="radio"/> 0.00% Positive	<input checked="" type="radio"/> 0.00% Neutral	<input checked="" type="radio"/> 0.00% Negative

YouTube channel link:

Scan the QR code to access the sample videos.



Action plan of the ICT Tools and e-content committee (General English) for the even semester ICT and e-content

- To encourage more students to create content and share the content in social media.
- To encourage staff members to create content based on the syllabus.
- To add more multimedia based (audio/ video) content.
- To create a team of social media content creators for the department and college.

Report submitted by:

- Prof. Premjith Mathew, Assistant Professor, Department of English *P*
- Prof. Dinesh Kumar, Assistant Professor, Department of English *RD*

Noted by - Dr. Karpagavalli, Head of the Department of English (Shift 2).

*Dr. C. Karj*  
*15/12/2023*  
Dharmasurathi Rao Babbar  
Calovela Ganesh Chetty's Hindu College (Shift 2)  
Pottubetam, Chennai-600073



for a language lab should be prepared based on the survey. The same should be submitted to the Principal and the Director.

- It was decided in the meeting to plan for a workshop on ICT Tools for the teachers in the second week of August. The objective of the workshop is to enable teachers to familiarize with the necessary IT and e-content generation skills.
- It is imperative that teachers prepare e-content for their respective classes and share it in the department WhatsApp group for documentation purpose. It was suggested that every teacher create at least one e-content for their students.
- It was also decided that an MoU can be signed with a company or an organization specializing in e-content/ digital tools.

The following duties and responsibilities were discussed and approved by the Head of the Department:

- Prof. Karthi will take care of the e-content generation in the BA English classes by creating an exclusive online group.
- Prof. Premjith will work to create a WhatsApp group for all the first-year students and will focus on content generation for Part II English.
- Prof. Dinesh, apart from Naan Mudhalvan project will offer his assistance to both B.A English and Part II English WhatsApp groups.

The meeting ended at 11. 30 am.

#### ACTIVITIES:

A WhatsApp group was created in the month of July 2023 to publish the e-content created by the staff and students. Most of the content created were related to the First Year general English syllabus. The common format used was digital posters. Assessment using Kahoot was also conducted through the WhatsApp group along with some in-app based quizzes and polls. Students who scored high marks were given cash awards and books as prizes. A WhatsApp group was also created for the second year General English students. (Science students) with the approval of the Head of the Department. Some of the e-content created (sample posters) can be accessed by scanning this QR code.



*C. Karthi*  
Dharmamurthi Rao Bahadur  
Gandhi Commemorative Chetty's Hindu College (Shift 2)  
Dharmamurthi Nagar,  
Post: Narayanapuram, Chennai-600072

**Sample report of the Kahoot Quizzes conducted for the students is given below:**

Know Your State - The English Hub - Weekend Quiz			
Played on	26 Aug 2023		
Hosted by	Premjith7723		
Played with	100 players		
Played	10 of 10		
Overall Performance			
Total correct answers (%)	53.80%		
Total incorrect answers (%)	46.20%		
Average score (points)	4418.87 points		
Feedback			
Number of responses	0		
How fun was it? (out of 5)	0.00 out of 5		
Did you learn something?	0.00% Yes	0.00% No	
Do you recommend it?	0.00% Yes	0.00% No	
How do you feel?	<input checked="" type="radio"/> 0.00% Positive	<input checked="" type="radio"/> 0.00% Neutral	<input checked="" type="radio"/> 0.00% Negative

**YouTube channel link:**

Scan the QR code to access the sample videos.



**Action plan of the ICT Tools and e-content committee (General English) for the next academic year**

- To encourage more students to create content and share the content in social media.
- To encourage staff members to create content based on the syllabus.
- To add more multimedia based (audio/ video) content.
- To create a team of social media content creators for the department and college.

*C. Jay*  
Dharmamurthi Rao Bahadur  
Calsvrato Campus, Christy's Hindu College (Shift 2)  
Dharmamurthi Nagar,  
Perthambur, Chennai-600072

## FEEDBACK FOR THE E-CONTENT ACTIVITY OF THE DEPARTMENT:

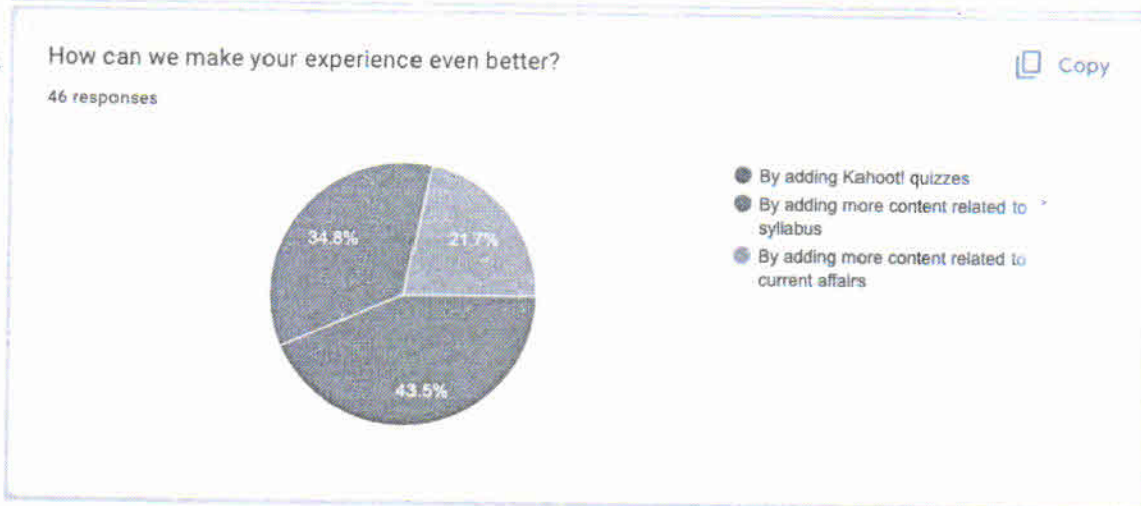
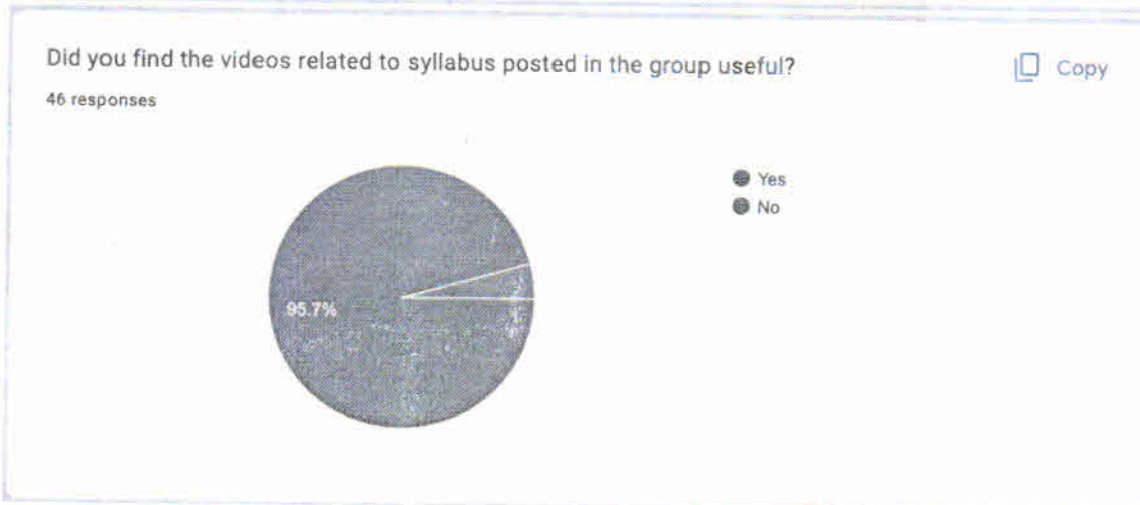
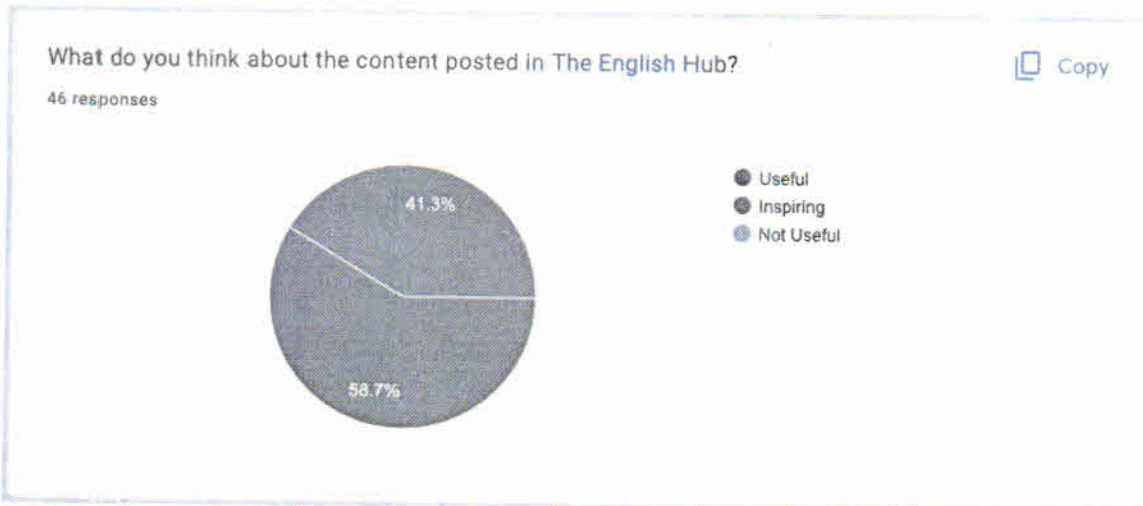

Report submitted by:

1. Prof. Premjith Mathew, Assistant Professor, Department of English
2. Prof. Dinesh Kumar, Assistant Professor, Department of English

Noted by - Dr. Karpagavalli, Head of the Department of English (Shift 2)

*[Handwritten Signature]*  
Dr. Premjith Mathew  
Department of English  
Calevra College  
Periyar, Chennai-600072

# Department of Computer Science with Data Science

## Varied Instructional Techniques

1. Live Demonstration using LCD projector
2. Power Point Presentation
3. Animated Videos
4. Web Bibliography
5. Whatapps
6. Google Forms
7. Google Class room
8. Spoken Tutorials – IIT Bombay
9. Swayam
10. NPTEL
11. Students Teaching Students
12. Peer Tutoring
13. [www.w3schools.com](http://www.w3schools.com)
14. [www.tutorialspoint.com](http://www.tutorialspoint.com)

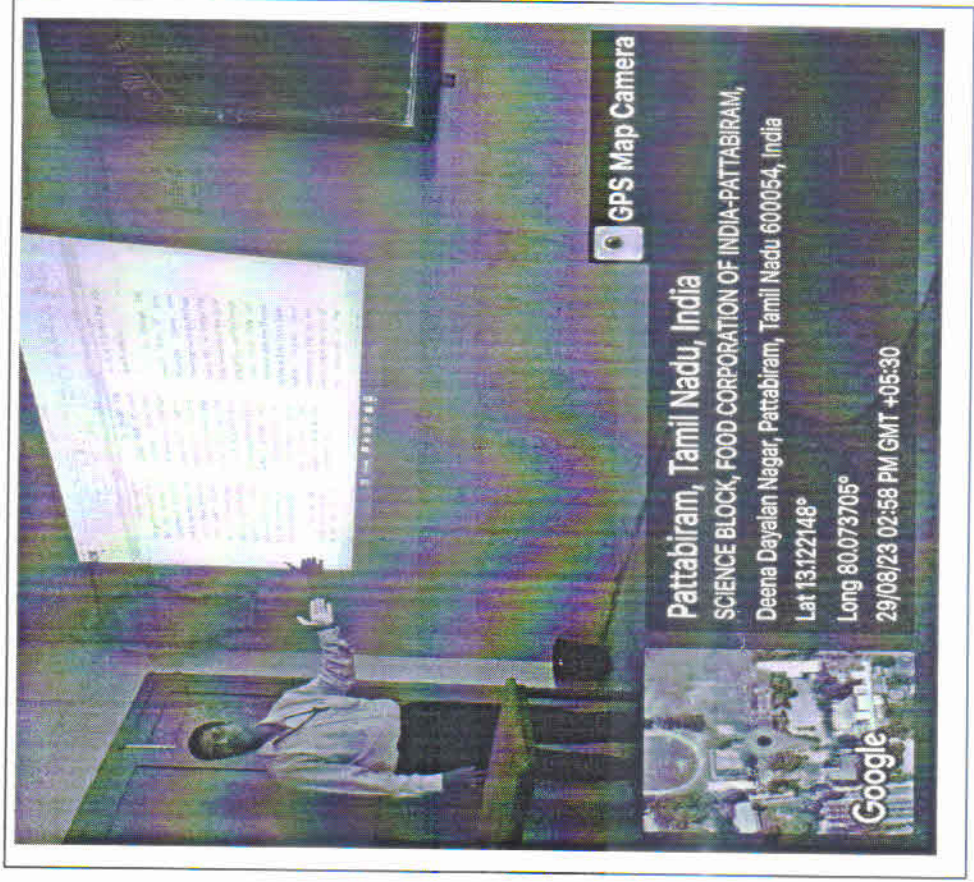

S.A  
9.3

# Dept. of Computer Science with Data Science

## Google Class Room

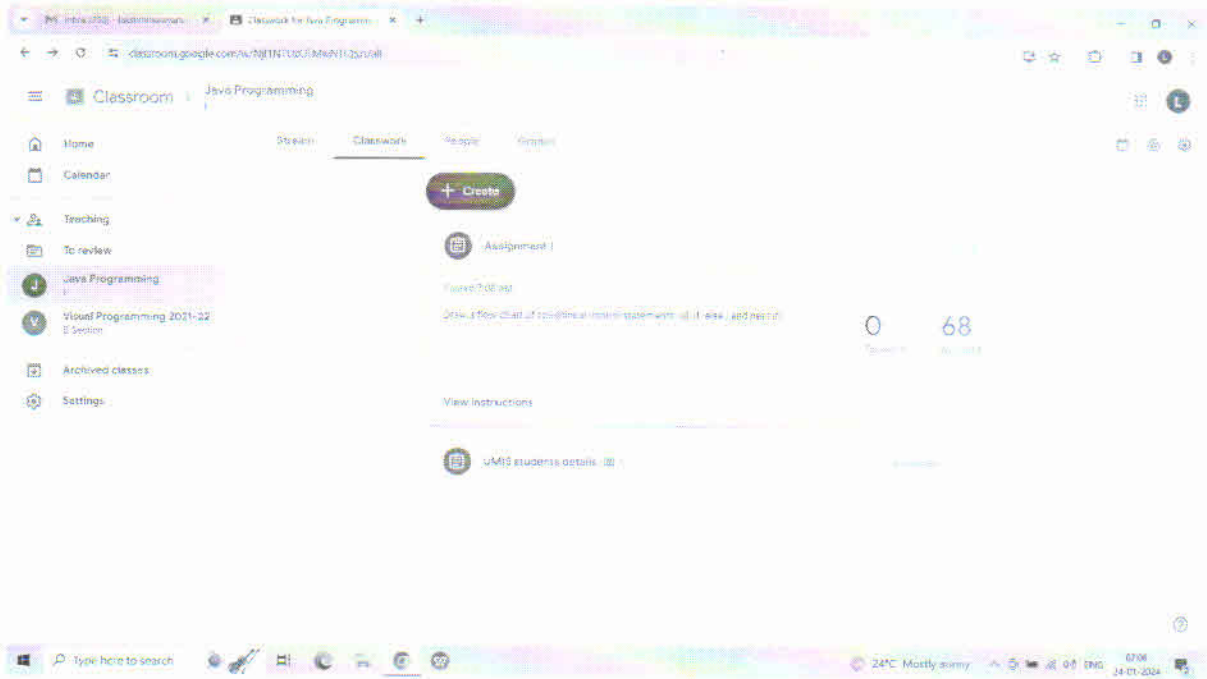

Dhille

HOD of CS with  
DS

2.3.2

ICT Tool:

2.3.2

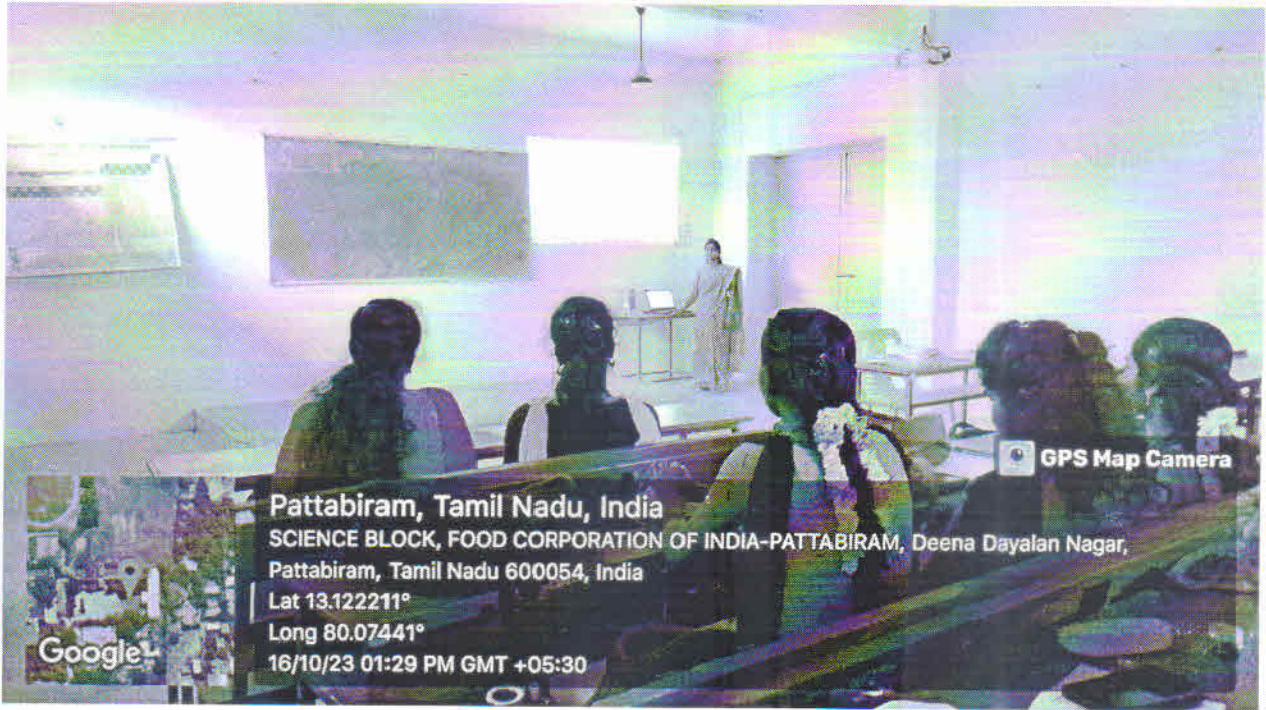

HEAD OF THE DEPARTMENT  
Department of Chemistry  
Dharmamurthi Rao Bahadur  
Calavala Cunnan Chetty's Hindu College (Shift 2)  
Dharmamurthi Nagar, Pattabiram, Chennai-72

PRINCIPAL,  
DHARMAMURTHI RAO BAHADUR CALAVALA CUNNAN  
CHETTY'S HINDU COLLEGE,  
DHARMAMURTHI NAGAR, PATTABIRAM,  
CHENNAI - 600 072.



**DHARMAMURTHI RAO BAHADUR CALAVALA CUNNAN CHETTY'S HINDU  
COLLEGE**

**PATTABIRAM, CHENNAI-600 072**

**DEPARTMENT OF COMPUTER APPLICATIONS**



**ICT TOOLS**

**2023-2024**

**ODD SEMESTER**

*C. Kalimuthu*

**PRINCIPAL,  
DHARMAMURTHI RAO BAHADUR CALAVALA  
CUNNAN CHETTY'S HINDU COLLEGE,  
DHARMAMURTHI NAGAR,  
PATTABIRAM, CHENNAI - 600 072.**



## REPORT ON ICT TOOLS

Information and Communication Technologies (ICT) have revolutionized the education landscape, and nowhere is this more evident than in colleges. From interactive learning platforms to cutting-edge research tools, ICT tools are transforming the way students learn, faculty teach, and institutions operate. This report explores the specific Information and Communication Technology (ICT) tools used for students focused on four key tools:

- Google Classroom
- Quizizz.com
- PowerPoint presentations
- WhatsApp

It will analyze their individual strengths and weaknesses, their impact on my learning, and potential areas for improvement.

### 1. Google Classroom:

- Strengths: Provides a centralized platform for course materials, assignments, and communication. Enables easy organization and access to resources.
- Weaknesses: Primarily text-based, limiting interactive and multimedia content.
- Impact on Learning: Google Classroom has streamlined my organization and access to course materials, facilitating better time management. It offers valuable insights on my progress and areas for improvement.
- Google Classroom link:- <https://classroom.google.com/c/NTIzMjE0?cjc=2lgifid>
- Reference book:-

Introduction To Computer Science Using Python – Charles Dierbach

<http://bedford-computing.co.uk/learning/wp-content/uploads/2015/10/Introduction-to-Computer-Science-Using-Python.pdf>

### 2. Quizizz.com:

- Strengths: Provides instant feedback and detailed performance analysis. Allows for personalized practice based on individual needs.
- Weaknesses: Limited scope for open-ended responses and critical thinking assessments.
- Impact on Learning: The personalized feedback loop helps me identify my strengths and weaknesses and target my studying effectively.
- Quizizz:- <https://quizizz.com/join>

### 3. PowerPoint Presentations:

- Strengths: Easy to create engaging presentations with multimedia elements. Effective for both individual and group projects.
- Weaknesses: Requires planning and creativity to avoid monotonous presentations.

- Impact on Learning: PowerPoint has enhanced my communication skills, ability to present information clearly and concisely, it has strengthened my critical thinking and organization skills during project development.
- Python Programming Unit 5 PPT Link:-  
[https://docs.google.com/presentation/d/1jAuu4EAI0X3KCvtKYezKnHOrNO2Ei682/edit?usp=drive\\_link&oid=106037122294220432878&rtpof=true&sd=true](https://docs.google.com/presentation/d/1jAuu4EAI0X3KCvtKYezKnHOrNO2Ei682/edit?usp=drive_link&oid=106037122294220432878&rtpof=true&sd=true)

#### 4. WhatsApp:

- Strengths: Convenient and instant communication tool for connecting with classmates outside the classroom.
- Weaknesses: Can be distracting and disrupt focus if not used responsibly. Potential for misinformation and lack of formal structure compared to dedicated educational platforms.
- Impact on Learning: WhatsApp has fostered collaboration and peer-to-peer learning outside the classroom environment. It allows for quick inquiries and clarifications.
- WhatsApp Group Link:- <https://chat.whatsapp.com/DR5Hi2h6zs61zJQZ4T0dpr>

## TOPIC:- INTRODUCTION TO PYTHON PROGRAMMING

### PRESENTATION PHOTOS

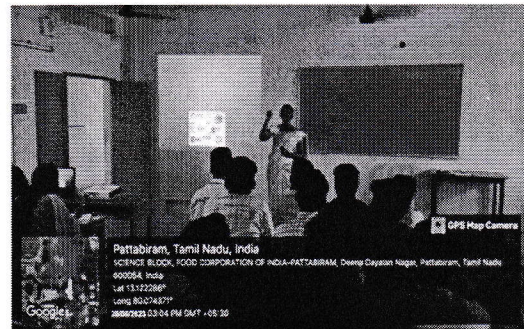
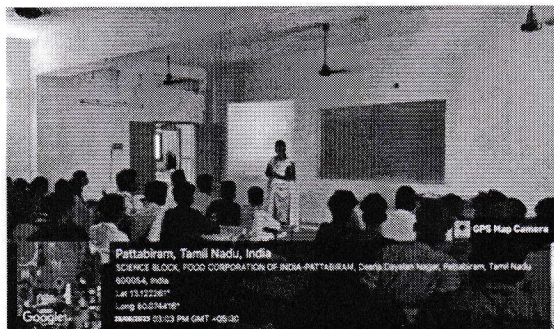
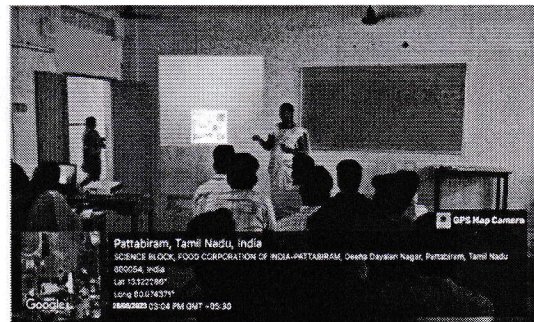
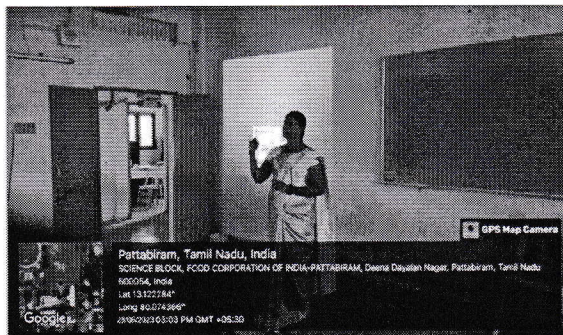

### ICT TOOLS GOOGLE DRIVE LINK:

[https://drive.google.com/drive/folders/1iWKOJ39N\\_-4Orj3Q3rt1-JCdaJaylPuQ?usp=drive\\_link](https://drive.google.com/drive/folders/1iWKOJ39N_-4Orj3Q3rt1-JCdaJaylPuQ?usp=drive_link)

**Conclusion:**

The ICT tools mentioned above have become essential elements of my student toolbox, each serving a distinct purpose and impacting my learning differently. From streamlined organization and communication to gamified assessments and collaborative presentations, these tools enhance learning experience and make it more engaging and effective.

*[Handwritten Signature]*

**CLASS INCHARGE**

*[Handwritten Signature]*  
**HEAD OF THE DEPARTMENT**

**Dr. N. VENKATARAMANAN,**  
ME, M.Sc(Maths), M.Phil, PGDCA, B.Ed, Ph.D  
Associate Professor & Head  
Dept of Computer Applications  
**DRBCCC HINDU COLLEGE**  
Pattabiram, Chennai-600 072, TN, India.



*[Handwritten Signature]*  
**PRINCIPAL,**  
**DHARMAMURTHI RAO BAHABUR CALAYALA**  
**CUNNAN CHETTY'S HINDU COLLEGE,**  
**DHARMAMURTHI NAGAR,**  
**PATTABIRAM, CHENNAI - 600 072**

**DHARMAMURTHI RAD BAHADUR CALAYALA CUNNAN CHETTY'S HINDU  
COLLEGE**

**PATTTABIRAM, CHENNAI-600 072**

**DEPARTMENT OF COMPUTER APPLICATIONS**



**PEER TUTORING**

**2023-2024**

**ODD SEMESTER**



*G. Velupillay*  
PRINCIPAL,  
DHARMAMURTHI RAD BAHADUR CALAYALA  
CUNNAN CHETTY'S HINDU COLLEGE,  
PATTTABIRAM

## REPORT ON PEER TUTORING

Peer tutoring is a teaching and learning strategy in which students learn with and from each other without the immediate intervention of a teacher. Peer tutoring schemes frequently appeal to educators in Higher Education, and there is much literature examining implementation and assessment. Peer tutoring can help tutors develop communication skills, leadership skills, and a sense of personal satisfaction. This report is on peer teaching in a 1:5 student ratio, which is a form of small group learning that can be effective in promoting student engagement, active learning, and critical thinking.

The following topics were discussed during peer tutoring session.

### 1. Python Literals:

A literal in Python is a syntax that is used to completely express a fixed value of a specific data type. Literals are constants that are self-explanatory and don't need to be computed or evaluated.

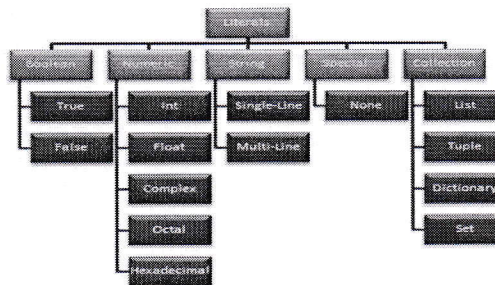

### 2. Exception Handling:

The try...except block is used to handle exceptions in Python. When an exception occurs, it is caught by the except block. The except block cannot be used without the try block. The finally block is always executed no matter whether there is an exception or not.

```
try:
    print(x)
except:
    print("Something went wrong")
finally:
    print("The 'try except' is finished")
```

### 3. Python Operators:

In Python programming, Operators in general are used to perform operations on values and variables. These are standard symbols used for the purpose of logical and arithmetic operations.

## Peer Tutoring Approach

The interactive peer tutoring session was conducted with a 1:5 student ratio. The session was designed to be interactive and engaging, with peer tutors providing personalized attention and support to each student. The session was structured to help students understand concepts that they couldn't comprehend and provided the peer tutors with the revision of those topics.

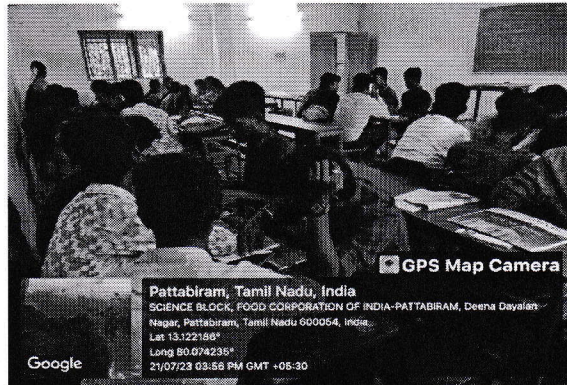
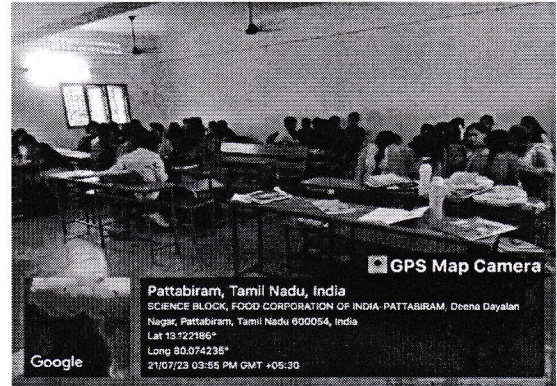
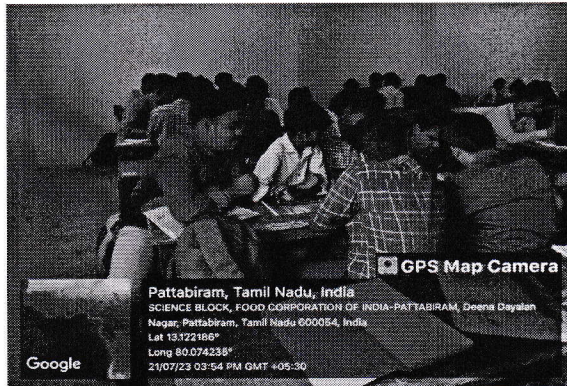

## CONCLUSION

Overall, the interactive peer tutoring session was a positive experience for everyone involved. The 1:5 student ratios allowed for more personalized attention and support for each student, which was especially beneficial for students who may have difficulty understanding certain concepts. Additionally, the peer tutors themselves benefited from the experience by developing communication skills, leadership skills, and a sense of personal satisfaction.

*[Signature]*  
CLASS INCHARGE



*G. Valluvaray*  
PRINCIPAL,  
MAMMURTHI RAO BAHADUR CALAVALA  
KUNNANI CHELTY'S HINDU COLLEGE,  
DHARMOOR, CHINNAICOLLI

*[Signature]*  
HEAD OF THE DEPARTMENT

**Dr. N. VENKATARAMANAN,**  
ME, M.Sc(Maths), M.Phil, PGDCA, B.Ed, Ph.D  
Associate Professor & Head  
Dept of Computer Applications  
DRBCC HINDU COLLEGE  
Chennai-600 072 TN, India.

**DHARMAMURTHI RAO BAHADUR CALAYALA CUNNAN CHETTY'S HINDU  
COLLEGE**

**PATTABIRAM, CHENNAI-600 072**

**DEPARTMENT OF COMPUTER APPLICATIONS**



**PEER TEACHING**

**2023-2024**

**ODD SEMESTER**



*G. Kalinayagi*  
PRINCIPAL,  
DHARMAMURTHI RAO BAHADUR CALAYALA  
CUNNAN CHETTY'S HINDU COLLEGE,  
PATTABIRAM, CHENNAI-600 072.

**DHARMAMURTHI RAO BAHADUR CALAVALA**  
**CUNNAN CHETTY'S HINDUCOLLEGE PATTABIRAM**  
**CHENNAI - 72**

**DEPARTMENT OF COMPUTER APPLICATION**

**III BCA 'A'**

**PEER TO PEER TEACHING**

**RDBMS**

S.NO	REG.NO	NAME	DETAILS	DATE
1	212100216	R.AJAY RATHAM	PEER TO PEER TEACHING	24.10.2023
2	212100219	S.ARJUN	PEER TO PEER TEACHING	29.10.2023
3	212100222	R.BALAJI	PEER TO PEER TEACHING	30.10.2023
4	212100230	A.V.CHINMAI SAGAR	PEER TO PEER TEACHING	04.11.2023
5	212100231	V.GOKUL RAJ	PEER TO PEER TEACHING	02.11.2023
6	212100255	S.GOKUL	PEER TO PEER TEACHING	03.11.2023
7	212100262	R.PRASHANT	PEER TO PEER TEACHING	07.11.2023
8	212100263	E.N.SAI KUMAR	PEER TO PEER TEACHING	05.11.2023
9	212100260	N.SANTHANA KRISHNA	PEER TO PEER TEACHING	06.11.2023
10	212100273	S.K.SHARATH KUMAAR	PEER TO PEER TEACHING	15.11.2023
11	212100276	R.VIGNESH	PEER TO PEER TEACHING	10.11.2023
12	212100288	V.VIJAY JOSHWA	PEER TO PEER TEACHING	11.11.2023
13	212100290	O.J.JASMINE	PEER TO PEER TEACHING	12.11.2023
14	212100308	M.KALAVANI	PEER TO PEER TEACHING	14.11.2023

**Subject Incharge**

*R. SURESH*

**HOD**

**Dr. N. VENKATARAMAN,**  
ME, M.Sc(Maths), M.Phil, PGDCA, B.Ed, Ph.D  
Associate Professor & Head  
Dept of Computer Applications  
DRBCC HINDU COLLEGE  
Pattabiram, Chennai-600 072, TN, India.



*N. Venkatarayan*  
PRINCIPAL,  
DHARMAMURTHI RAO BAHADUR CALAVALA  
CUNNAN CHETTY'S HINDU COLLEGE,  
PATTABIRAM, CHENNAI - 600 072, TN, INDIA.

**DHARMAMURTHI RAO BAHADUR CALAVALA  
CUNNAN CHETTY'S HINDU COLLEGE PATTABIRAM  
CHENNAI - 72**

**DEPARTMENT OF COMPUTER APPLICATION  
PEER TO PEER TEACHING - III BCA 'A'**

**RDBMS**

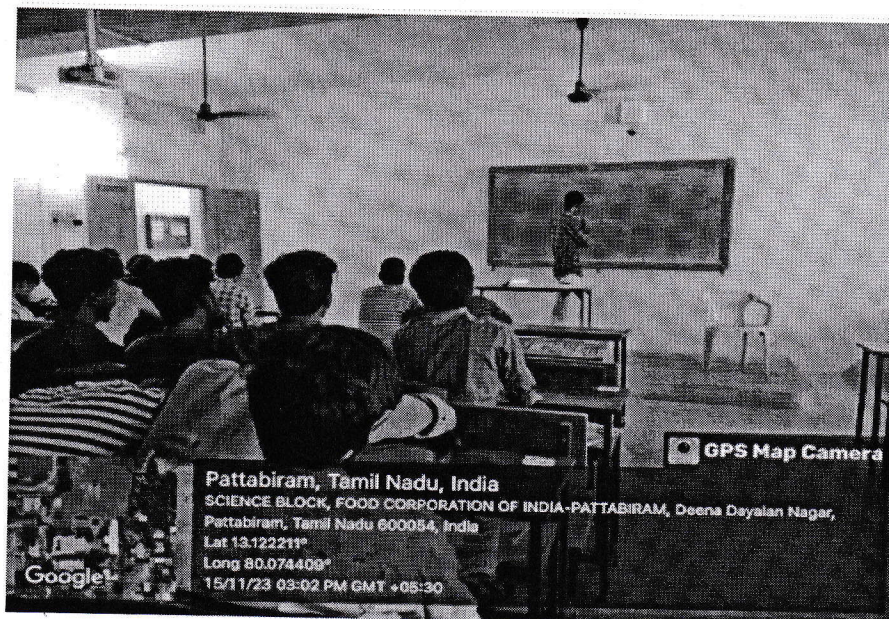
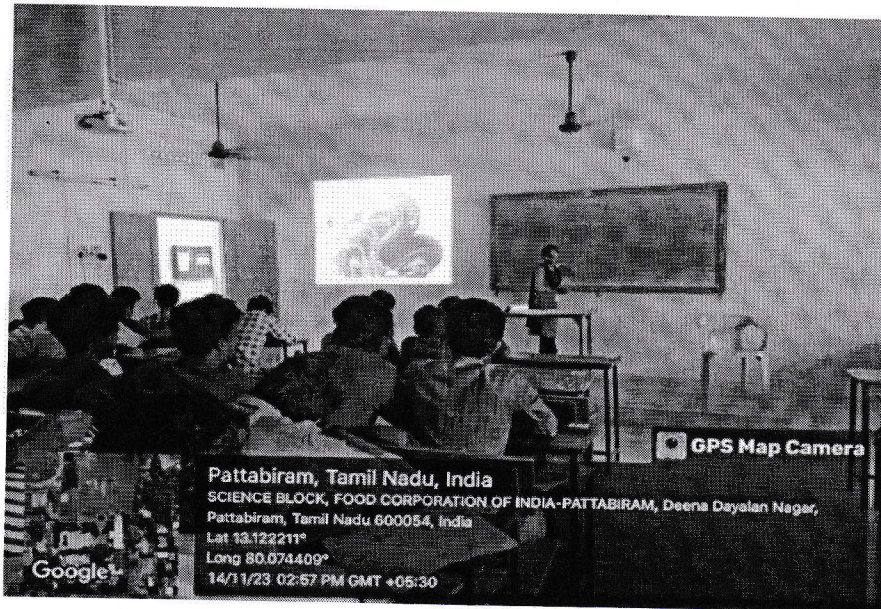

**DHARMAMURTHI RAO BAHADUR CALAVALA**  
**CUNNAN CHETTY'S HINDUCOLLEGE PATTABIRAM**  
**CHENNAI – 72**

**DEPARTMENT OF COMPUTER APPLICATION**

**III BCA 'A'**

**PEER TO PEER TEACHING**

**MULTIMEDIA AND ITS APPLICATION**

S.NO	REG.NO	NAME	DETAILS	DATE
1	212100216	R.AJAY RATHAM	PEER TO PEER TEACHING	26.10.2023
2	212100219	S.ARJUN	PEER TO PEER TEACHING	29.10.2023
3	212100222	R.BALAJI	PEER TO PEER TEACHING	30.10.2023
4	212100230	A.V.CHINMAI SAGAR	PEER TO PEER TEACHING	01.11.2023
5	212100231	V.GOKUL RAJ	PEER TO PEER TEACHING	02.11.2023
6	212100255	S.GOKUL	PEER TO PEER TEACHING	03.11.2023
7	212100262	R.PRASHANT	PEER TO PEER TEACHING	04.11.2023
8	212100263	E.N.SAI KUMAR	PEER TO PEER TEACHING	05.11.2023
9	212100260	N.SANTHANA KRISHNA	PEER TO PEER TEACHING	06.11.2023
10	212100273	S.K.SHARATH KUMAAR	PEER TO PEER TEACHING	07.11.2023
11	212100276	R.VIGNESH	PEER TO PEER TEACHING	10.11.2023
12	212100288	V.VIJAY JOSHWA	PEER TO PEER TEACHING	11.11.2023
13	212100290	O.J.JASMINE	PEER TO PEER TEACHING	12.11.2023
14	212100308	M.KALAVANI	PEER TO PEER TEACHING	14.11.2023

**Subject Incharge**

[JAYALAKSHMI]

**HOD**

**Dr. N. VENKATARAMANAN,**  
ME, M.Sc(Maths), M.Phil, PGDCA, B.Ed, Ph.D  
Associate Professor & Head  
Dept of Computer Applications  
DRBCCC HINDU COLLEGE  
Pattabiram, Chennai-600 072, TN, India.

**DHARMAMURTHI RAO BAHADUR CALAVALA**  
**CUNNAN CHETTY'S HINDU COLLEGE PATTABIRAM**  
**CHENNAI - 72**

**DEPARTMENT OF COMPUTER APPLICATION**  
**PEER TO PEER TEACHING - III BCA 'A'**

**MULTIMEDIA AND ITS APPLICATION**

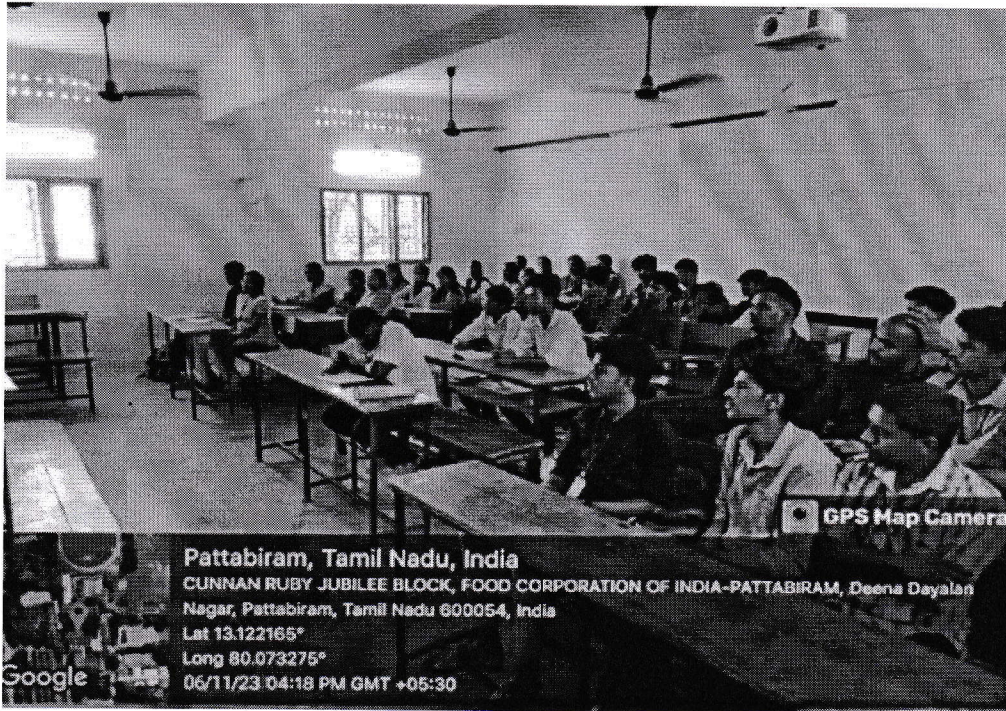

*G. Mahalingam*

PRINCIPAL.

**DHARMAMURTHI RAO BAHADUR CALAVALA**  
**CUNNAN CHETTY'S HINDU COLLEGE PATTABIRAM**  
**CHENNAI – 72**

**DEPARTMENT OF COMPUTER APPLICATION**

**III BCA 'A'**

**PEER TO PEER TEACHING**

**SOFTWARE ENGINEERING**

S.NO	REG.NO	NAME	DETAILS	DATE
1	212100216	R.AJAY RATHAM	PEER TO PEER TEACHING	22.10.2023
2	212100219	S.ARJUN	PEER TO PEER TEACHING	26.10.2023
3	212100222	R.BALAJI	PEER TO PEER TEACHING	29.10.2023
4	212100230	A.V.CHINMAI SAGAR	PEER TO PEER TEACHING	01.11.2023
5	212100231	V.GOKUL RAJ	PEER TO PEER TEACHING	02.11.2023
6	212100255	S.GOKUL	PEER TO PEER TEACHING	23.11.2023
7	212100262	R.PRASHANT	PEER TO PEER TEACHING	04.11.2023
8	212100263	E.N.SAI KUMAR	PEER TO PEER TEACHING	15.11.2023
9	212100260	N.SANTHANA KRISHNA	PEER TO PEER TEACHING	06.11.2023
10	212100273	S.K.SHARATH KUMAAR	PEER TO PEER TEACHING	07.11.2023
11	212100276	R.VIGNESH	PEER TO PEER TEACHING	10.11.2023
12	212100288	V.VIJAY JOSHWA	PEER TO PEER TEACHING	11.11.2023
13	212100290	O.J.JASMINE	PEER TO PEER TEACHING	12.11.2023
14	212100308	M.KALAVANI	PEER TO PEER TEACHING	14.11.2023

**Subject Incharge**

**HOD**

**Dr. N. VENKATARAMANAN,**  
ME, M.Sc(Maths), M.Phil, PGDCA, B.Ed, Ph.D  
Associate Professor & Head  
Dept of Computer Applications  
DRBCC HINDU COLLEGE  
Pattabiram, Chennai-600 072, TN, India.

**DHARMAMURTHI RAO BAHADUR CALAVALA**  
**CUNNAN CHETTY'S HINDU COLLEGE PATTABIRAM**  
**CHENNAI - 72**

**DEPARTMENT OF COMPUTER APPLICATION**  
**PEER TO PEER TEACHING - III BCA 'A'**

**SOFTWARE ENGINEERING**

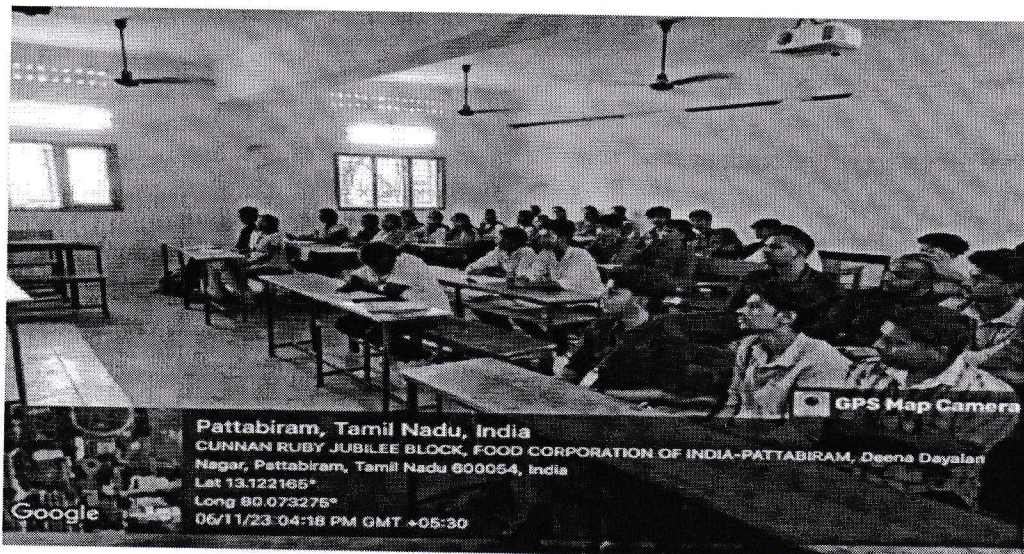
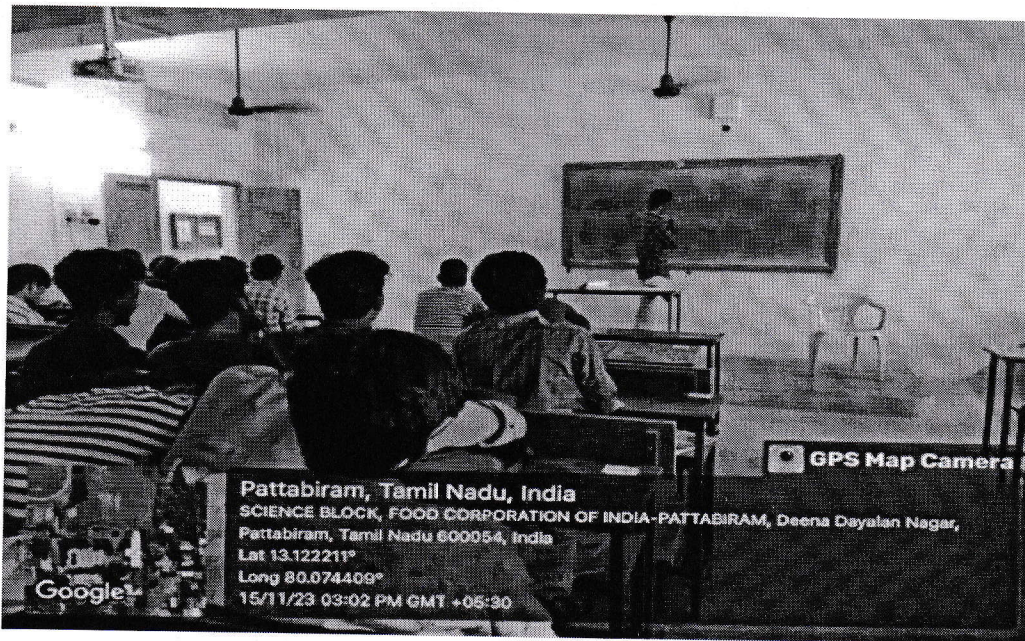

*G. Kalinmaray*  
PRINCIPAL,  
DHARMAMURTHI RAO BAHADUR CALAVALA  
CUNNAN CHETTY'S HINDU COLLEGE,  
DHARMAMURTHI NAGAR,  
PATTABIRAM, CHENNAI - 600 072

**DHARMAMURTHI RAO BAHADUR CALAVALA**  
**CUNNAN CHETTY'S HINDUCOLLEGE PATTABIRAM**  
**CHENNAI - 72**

**DEPARTMENT OF COMPUTER APPLICATION**

**III BCA 'A'**

**PEER TO PEER TEACHING**

**OPERATING SYSTEM**

S.NO	REG.NO	NAME	DETAILS	DATE
1	212100216	R.AJAY RATHAM	PEER TO PEER TEACHING	26.10.2023
2	212100219	S.ARJUN	PEER TO PEER TEACHING	29.10.2023
3	212100222	R.BALAJI	PEER TO PEER TEACHING	30.10.2023
4	212100230	A.V.CHINMAI SAGAR	PEER TO PEER TEACHING	01.11.2023
5	212100231	V.GOKUL RAJ	PEER TO PEER TEACHING	02.11.2023
6	212100255	S.GOKUL	PEER TO PEER TEACHING	03.11.2023
7	212100262	R.PRASHANT	PEER TO PEER TEACHING	04.11.2023
8	212100263	E.N.SAI KUMAR	PEER TO PEER TEACHING	05.11.2023
9	212100260	N.SANTHANA KRISHNA	PEER TO PEER TEACHING	06.11.2023
10	212100273	S.K.SHARATH KUMAAR	PEER TO PEER TEACHING	07.11.2023
11	212100276	R.VIGNESH	PEER TO PEER TEACHING	10.11.2023
12	212100288	V.VIJAY JOSHWA	PEER TO PEER TEACHING	11.11.2023
13	212100290	O.J.JASMINE	PEER TO PEER TEACHING	12.11.2023
14	212100308	M.KALAVANI	PEER TO PEER TEACHING	14.11.2023

*B. Gayathri*  
**Subject Incharge**

[B. GAYATHRI]

*Nh*  
**HOD**

**Dr. N. VENKATARAMAN.**  
ME, M.Sc(Maths), M.Phil, PGDCA, B.Ed, Ph.D  
Associate Professor & Head  
Dept of Computer Applications  
**DRBCC HINDU COLLEGE**  
Pattabiram, Chennai-600 072, TN, India.



*G. Ushinray*  
PRINCIPAL,  
DHARMAMURTHI RAO BAHADUR CALAVALA  
CUNNAN CHETTY'S HINDU COLLEGE

**DHARMAMURTHI RAO BAHADUR CALAVALA**  
**CUNNAN CHETTY'S HINDU COLLEGE PATTABIRAM**  
**CHENNAI - 72**

**DEPARTMENT OF COMPUTER APPLICATION**  
**PEER TO PEER TEACHING - III BCA 'A'**

**OPERATING SYSTEM**

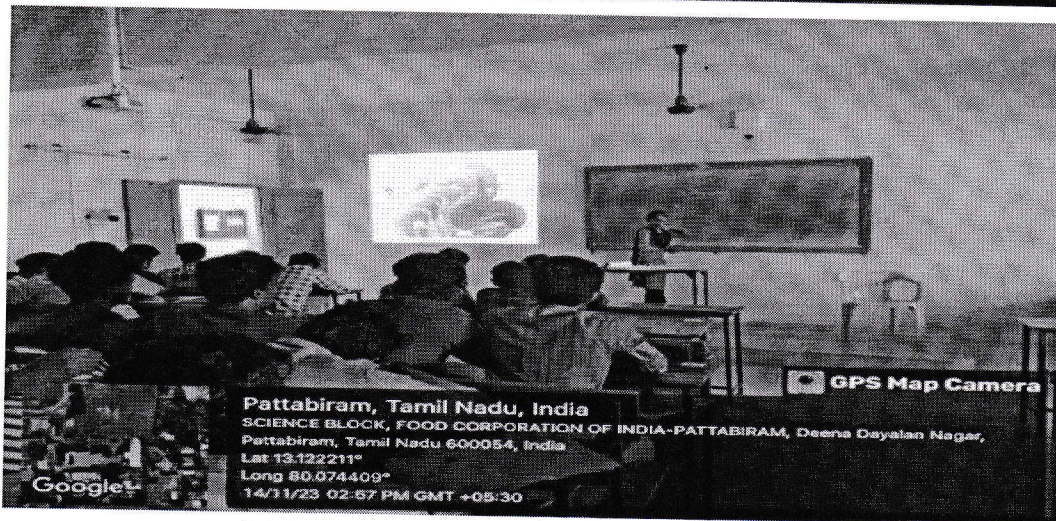
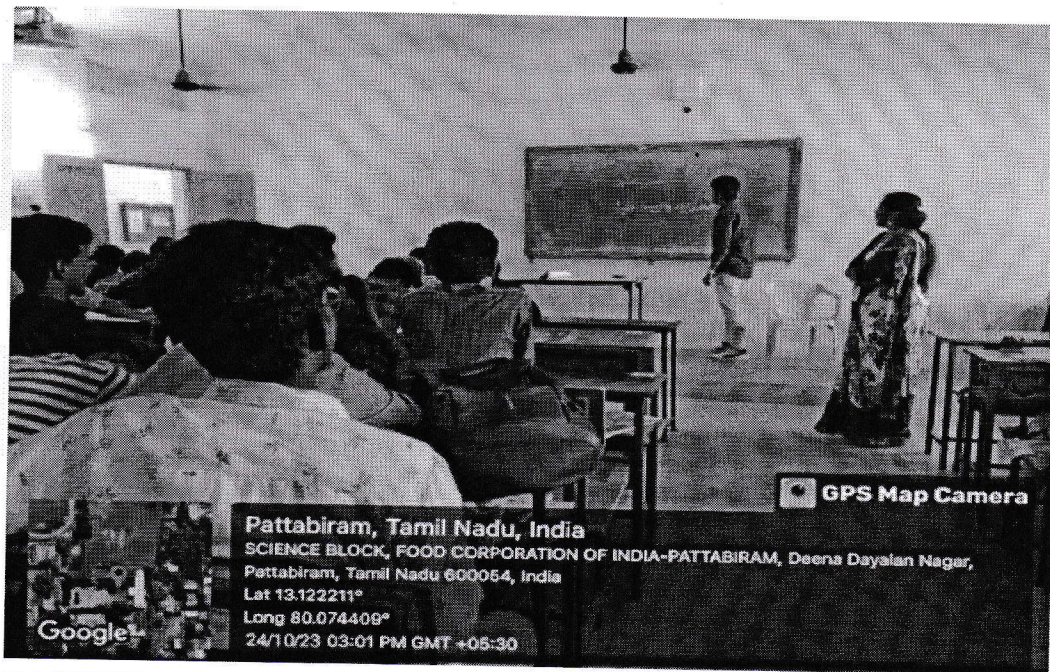

*C. Kalinrajan*  
PRINCIPAL,  
DHARMAMURTHI RAO BAHADUR CALAVALA  
CUNNAN CHETTY'S HINDU COLLEGE,

**DHARMAMURTHI RAD BAHADUR CALAYALA CUNNAN CHETTY'S HINDU  
COLLEGE**

**PATTABIRAM, CHENNAI-600 072**

**DEPARTMENT OF COMPUTER APPLICATIONS**



**ICT TOOLS**

**ODD SEMESTER**



*G. Kalinayagi*  
PRINCIPAL,  
DHARMAMURTHI RAD BAHADUR CALAYALA  
CUNNAN CHETTY'S HINDU COLLEGE,  
DHARMAMURTHI RAD BAHADUR  
PATTABIRAM, CHENNAI-600 072.

**DHARMAMURTHI RAO BAHADUR CALAYALA CUNNAN  
CHETTY'S HINDU COLLEGE PATTABIRAM CHENNAI – 72**

**DEPARTMENT OF COMPUTER APPLICATION**

**II BCAA**

**ICT TOOLS STUDENTS**

**STUDENT GROUP STUDY AND TEST**

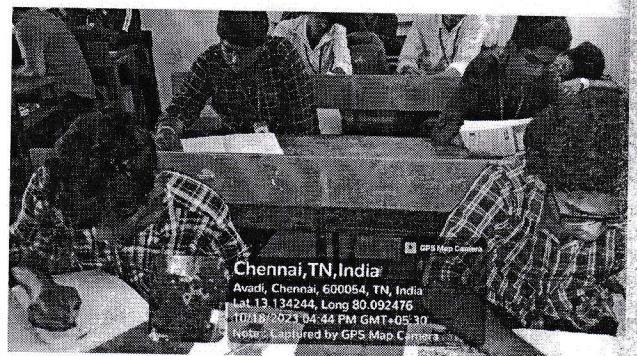
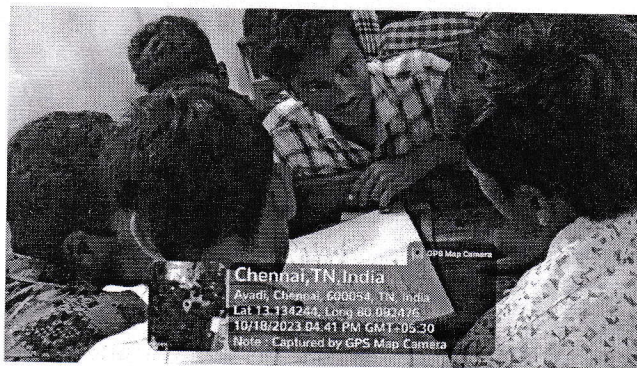

**REFERENCE BOOKS : PROGRAMMING WITH JAVA**  
(E balagurusamy- 5<sup>th</sup> and 6<sup>th</sup> Edition )

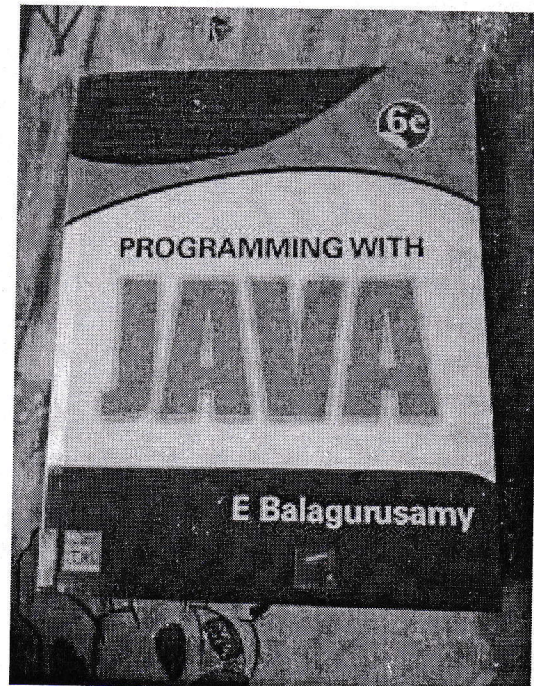
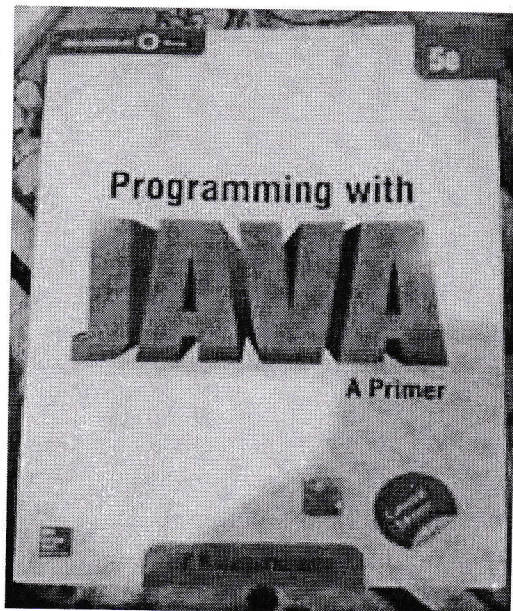

*C. Calayala*

**PRINCIPAL,  
DHARMAMURTHI RAO BAHADUR CALAYALA**

# GOOGLE CLASS :( group activity postgresql)

7:57 91%

BCA A 2022-2...

Add class comment

**MR. PARTHU**  
Sep 30, 2023

**SPOKEN TUTORIAL**

1 attachment

Add class comment

**New assignment: Group activity postgresql**  
Sep 27, 2023

Add class comment

**New assignment: Assignment 2 : Explain ab...**  
Aug 3, 2023 (Edited Aug 9, 2023)

Add class comment

**New assignment: Assignment1 : Explain diff...**  
Aug 3, 2023 (Edited Aug 9, 2023)

Add class comment

Stream Classwork People

7:56 91%

Group activity postgresql

**Aakash Aakash**  
Turned in

**Aakash D group.pdf**

Private comments

**Deepa G** Oct 11, 2023  
good

**Aakash Aakash** Oct 11, 2023  
Thank you mam

Add comment to Aakash Aakash

Return

7:55 92%

**Deepa G**

**Students**

- Aakash Aakash**
- Aarthi Baskar**
- Anbarasu .c**
- Arivazhagi Jesteen**
- Arun Kumar**
- Bhavani .k**

Stream Classwork People

# VIDEO AND AUDIO NOTES

[https://drive.google.com/file/d/1mcG-24uTt\\_DATM0vVW-8SEiwFeBixLJP/view?usp=sharing](https://drive.google.com/file/d/1mcG-24uTt_DATM0vVW-8SEiwFeBixLJP/view?usp=sharing)

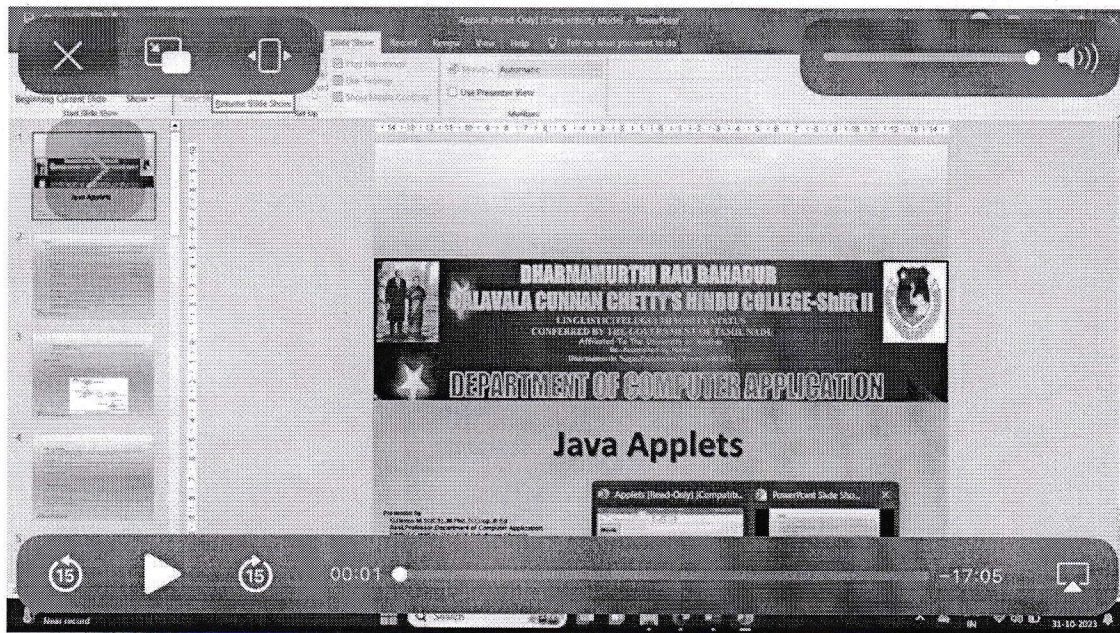

- **Client-Side Processing:** Applets offload some processing tasks from the web server to the client, potentially improving the server's performance and reducing network traffic.
- **Offline Usage:** Once an applet is downloaded, it can continue to run even when the user is not connected to the internet. This feature is useful for applications that require occasional or temporary disconnection from the web.

## 4.2 Life cycle of applet

### 1. Initialization (init() method):

The `init()` method is called when the applet is first loaded into the web browser. This method is typically used for one-time initialization tasks, such as setting up graphical components or initializing data. The `init()` method is executed only once during the applet's lifetime.

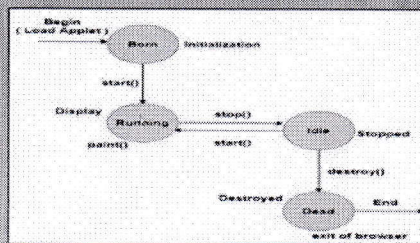

## YOUTUBE LEARNING:

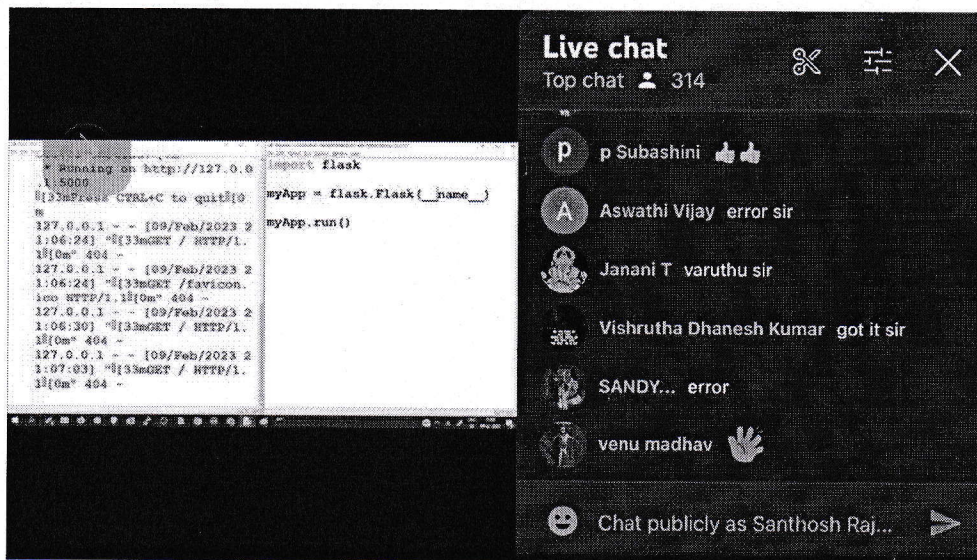
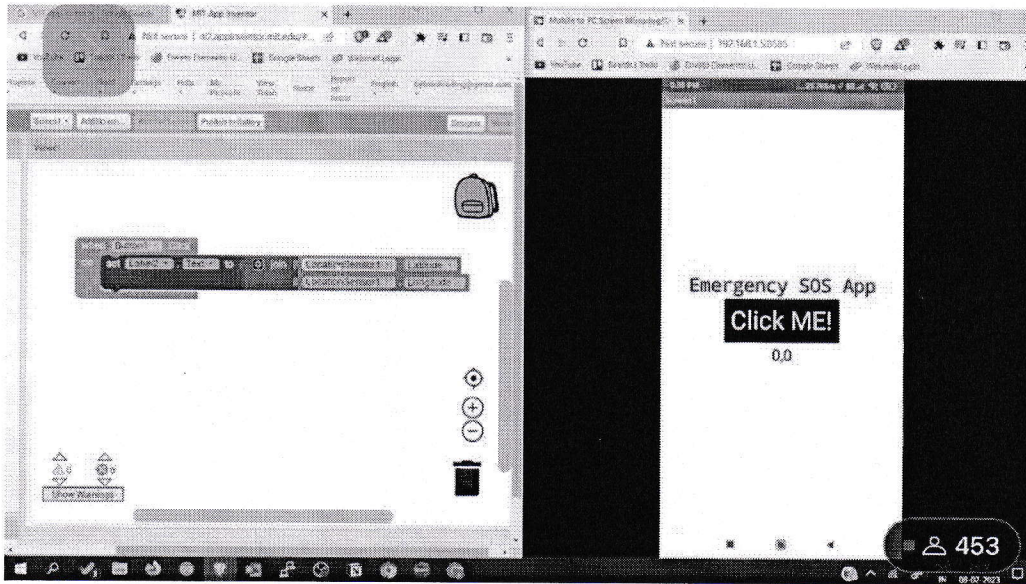

*G. Srinivasan*  
PRINCIPAL,  
DHARMAMURTHI RAO BAHADUR CALAYALA  
CUNNAN CHETTY HINDU COLLEGE

**DHARMAMURTHI RAO BHADHUR CALAVALA CUNNAN CHETTY'S  
HINDU COLLEGE PATTABIRAM CHENNAI – 72.**

**DEPARTMENT OF COMPUTER APPLICATION  
II-BCA-'A'**

**ICT TOOLS STUDENTS – COMPUTER ORGANISATION**

**STUDENT GROUP STUDY AND TEST**

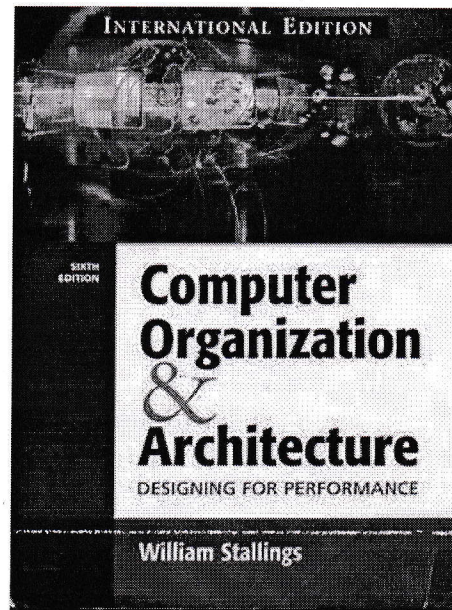
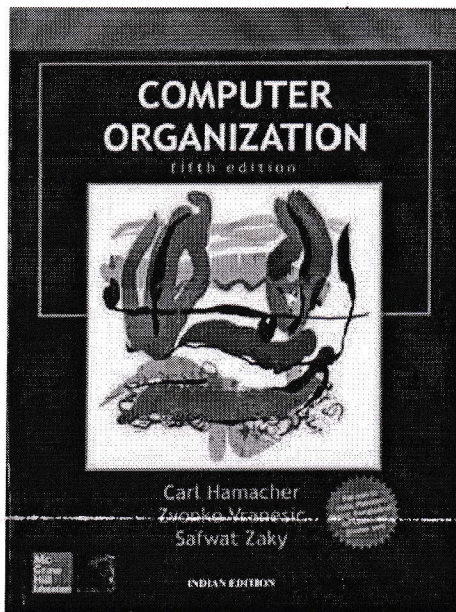
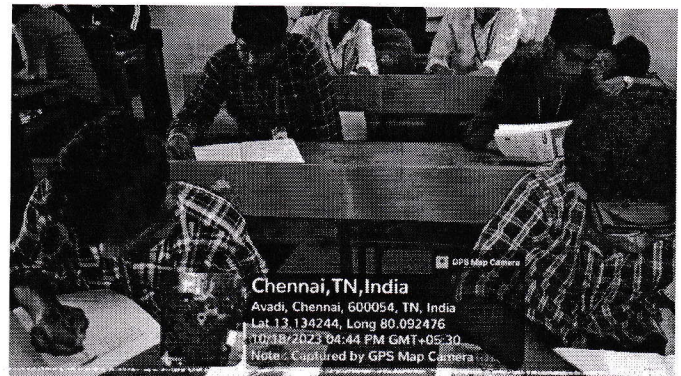
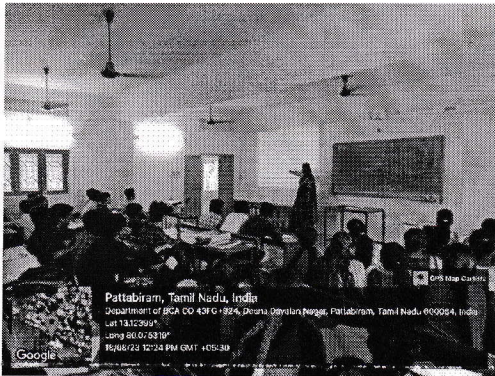

**REFERENCE BOOKS:**

1. Mathur- "Introduction to Microprocessor"- 3rd Edition- Tata McGraw-Hill-1993.
2. P. K. Ghosh and P. R. Sridhar- "0000 to 8085: Introduction to Microprocessors for Engineers and Scientists"- 2nd Edition- PHI- 1995.
3. NagoorKani- "Microprocessor (8085) and its Applications"- 2nd Edition- RBA Publications- 2006.
4. V. Vijayendran- "Fundamentals of Microprocessors – 8085"- S. Viswanathan Pvt. Ltd.- 2008.

**YOUTUBE VIDEO:**

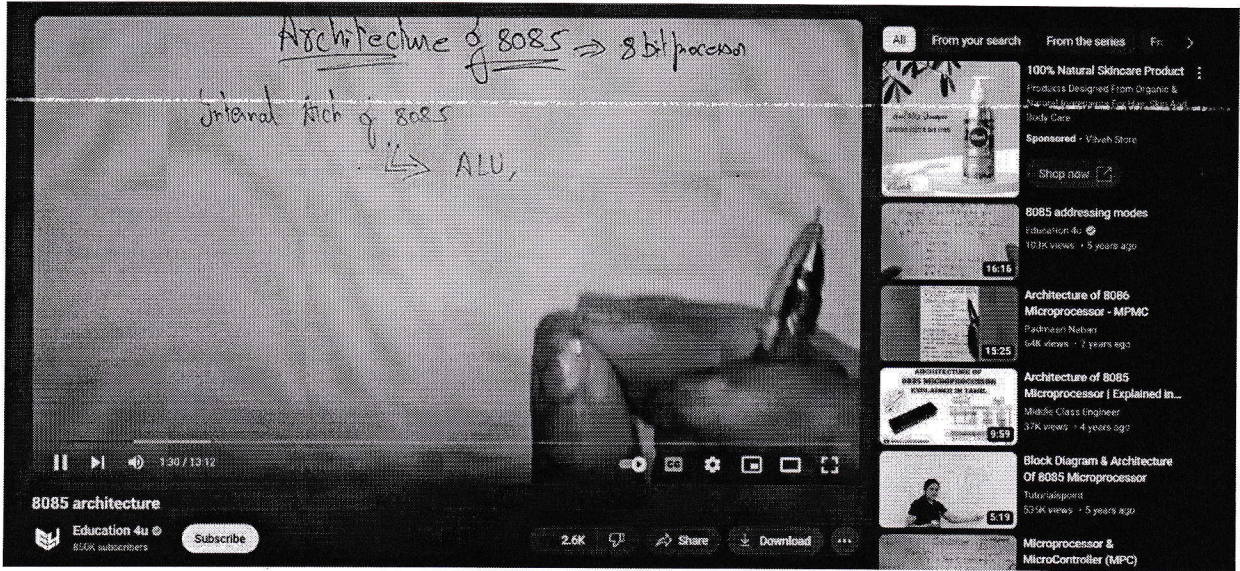

LINK:

<https://youtu.be/XEMyFUuV31o?si=mG90GxD4gueDt7fO>



*C. Kalinraaj*  
PRINCIPAL,  
DHARMAMURTHI RAO BAHADUR CALAVALA  
CUNNAN CHETTY'S HINDU COLLEGE,  
DHARMAMURTHI RAO BAHADUR,  
PATTABIRAM, CHENNAI - 600 072.

**DHARMAMURTHI RAO BAHADUR CALAVALACUNNAN  
CHETTY'SHINDUCOLLEGE PATTABIRAMCHENNAI-72**

**DEPARTMENT OF COMPUTER APPLICATION II**

**BCA A**

**ICT TOOLS STUDENTS**

**STUDENT GROUP STUDY AND TEST :**

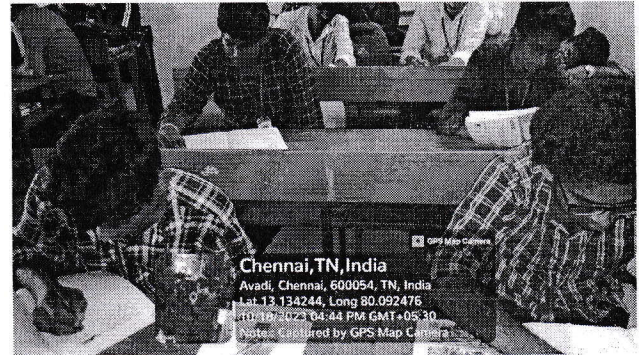
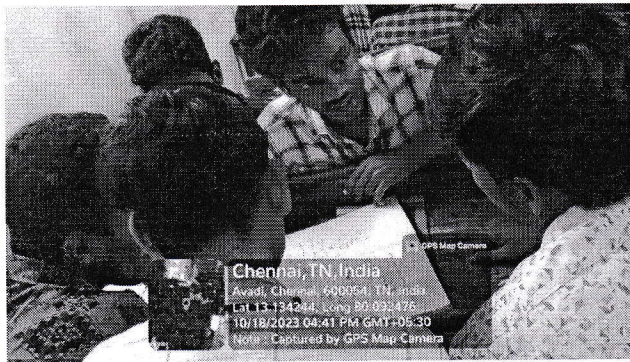

**REFERENCE BOOKS:** PROGRAMMING WITH DATA STRUCTURES ALGORITHM WITH  
(Ebalagurusamy-5<sup>th</sup> and 6<sup>th</sup> Edition) JAVA PROGRAMMING

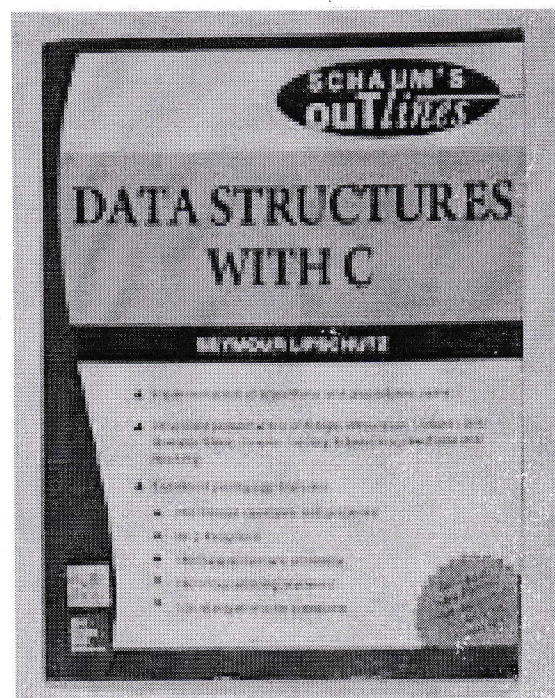

# GOOGLE CLASS : (ASSIGNMENT SUBMISION)

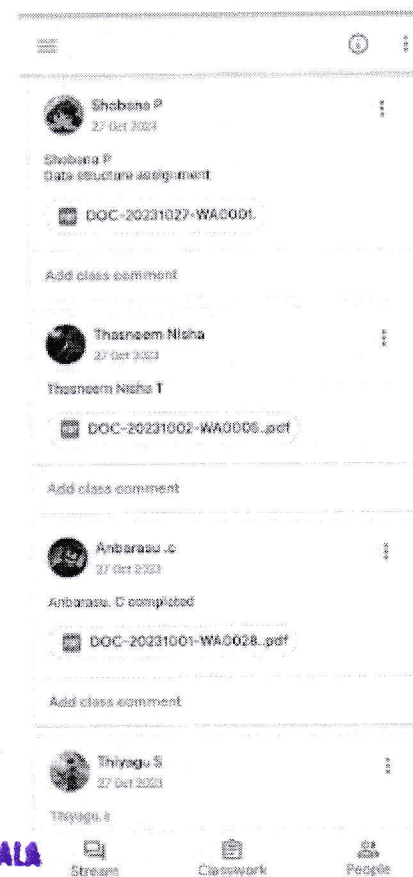
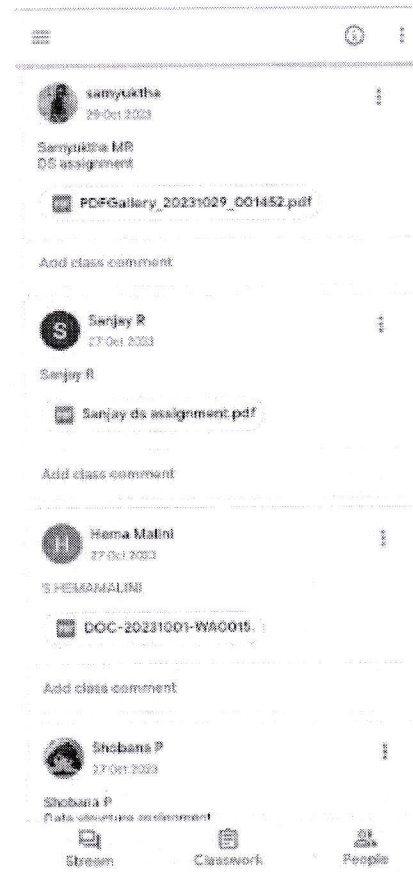
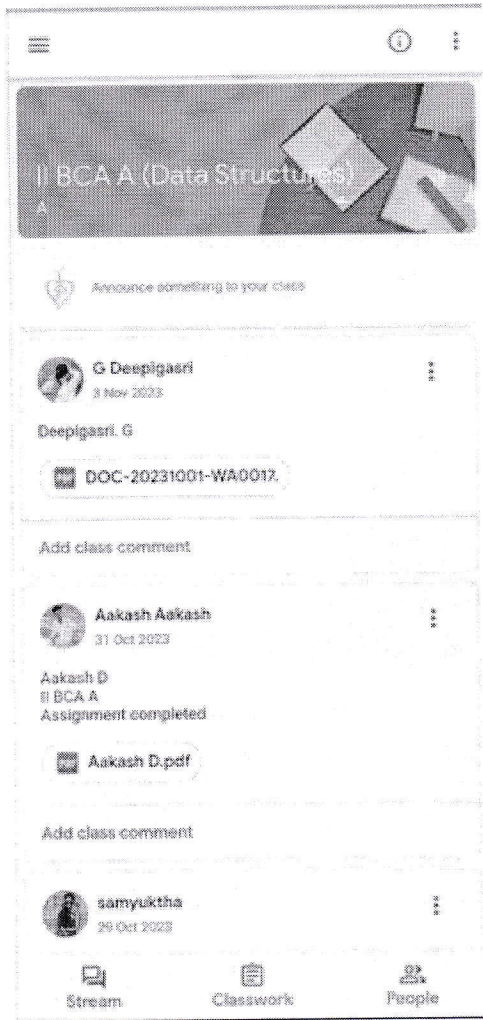

*G. valinvaraj*

PRINCIPAL,  
DHARMAMURTHI RAO BAHADUR CALAYALA  
CUNNAM CHETTY'S HINDU COLLEGE,  
DHARMAJEEVARAO STREET,  
PATTABIRAM, CHENNAI - 600 072

**DHARMAMURTHI RAO BAHADUR CALAYALA CUNNAN CHETTY'S HINDU  
COLLEGE**

**PATTABIRAM, CHENNAI-600 072**

**DEPARTMENT OF COMPUTER APPLICATIONS**



**ICT TOOLS**

**ODD SEMESTER**



*G. valimuraj*  
PRINCIPAL,  
DHARMAMURTHI RAO BAHADUR CALAYALA  
CUNNAN CHETTY'S HINDU COLLEGE,  
DHARMAMURTHI NAGAR,  
PATTABIRAM, CHENNAI - 600 072.

**DHARMAMURTHI RAO BAHADUR CALAVALA CUNNAN CHETTY'S**  
**HINDU COLLEGE PATTABIRAM CHENNAI – 72**

**DEPARTMENT OF COMPUTER APPLICATION**

**II BCA B**

**ICT TOOLS STUDENTS**

**REFERENCE :**

**TEXT BOOKS:**

1. E. Balagurusamy, "Programming with Java", TataMc-Graw Hill, 5<sup>th</sup> Edition.
2. Sagayaraj, Denis, Karthick and Gajalakshmi, "Java Programming for Core and advanced learners", Universities Press (INDIA) Private Limited 2018.

**REFERENCES:**

1. Herbert Schildt, "The complete reference Java", TataMc-Graw Hill, 7<sup>th</sup> Edition.

**WEB REFERENCES:**

- NPTEL & MOOC courses titled Java
- <https://nptel.ac.in/courses/106105191/>



*S. Calinvaraj*  
PRINCIPAL,  
DHARMAMURTHI RAO BAHADUR CALAVALA  
CUNNAN CHETTY'S HINDU COLLEGE,  
DHARMAMURTHI NAGAR,  
PATTABIRAM, CHENNAI - 600 072.

**DHARMAMURTHIRAOBHADHURCALAVALACUNNANCHETTY'SHINDU COLLEGE PATTABIRAM CHENNAI – 72.**

**DEPARTMENT OF COMPUTER APPLICATION**

**II-BCA-'B'**

**ICT TOOLS STUDENTS – PROGRAMMING IN JAVA**

**STUDENT GROUP STUDY AND TEST**

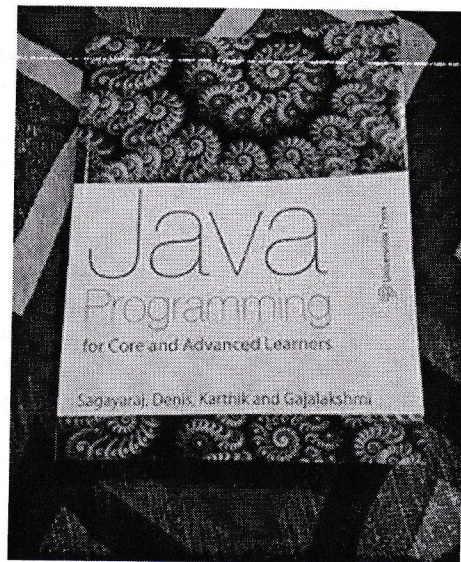
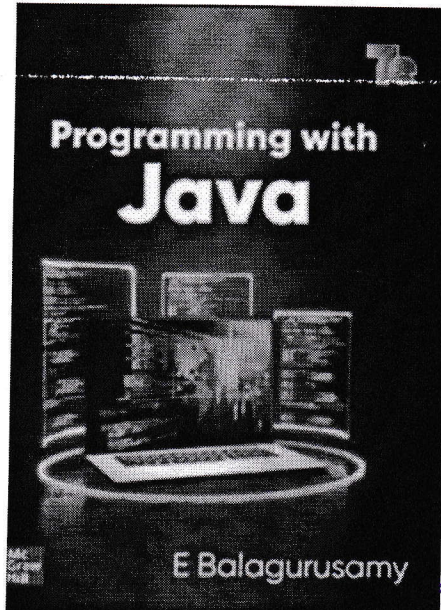
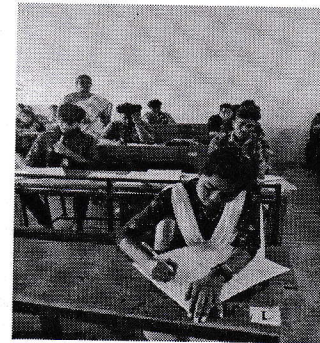
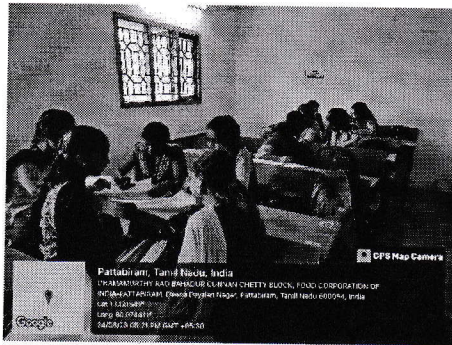

**TEXT BOOKS:**

1. E. Balagurusamy, "Programming in Java", TataMc\_Graw Hill, 5<sup>th</sup> Edition.
2. Sagayaraj, Denis, Karthick and Gajalakshmi, "Java Programming for Core and advanced learners", Universities Press (INDIA) Private Limited 2018.

**REFERENCES:**

1. Herbert Schildt, "The complete reference Java", TataMc-Graw Hill, 7 th Edition.

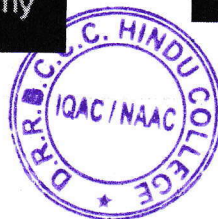

*G. Calayala*  
PRINCIPAL,  
DHARMAMURTHI RAO BAHADUR CALAYALA  
CUNNAN CHETTY'S HINDU COLLEGE,  
PATTABIRAM, CHENNAI - 600 072.

## GOOGLE CLASSROOM:

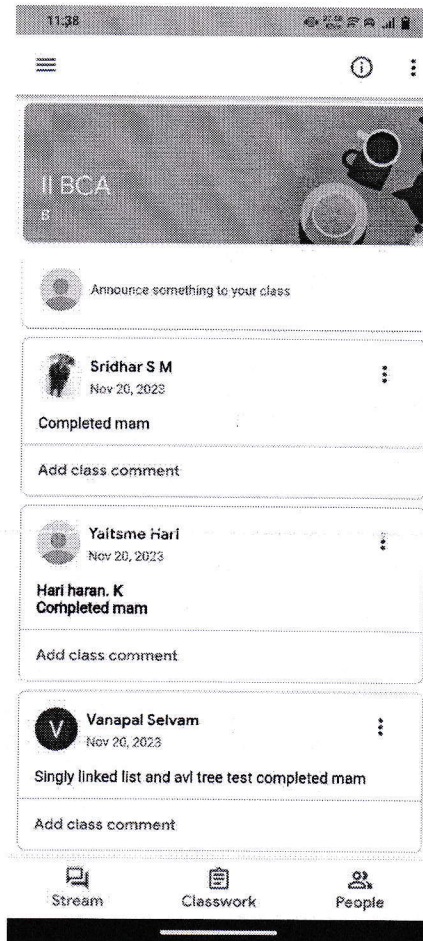
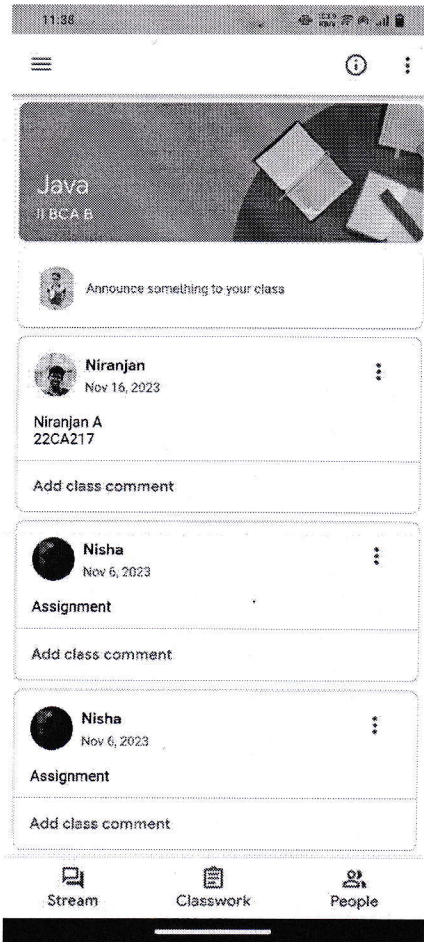

## YOUTUBEVIDEO:

**Java - Types of inheritance**

<p>Single inheritance</p> <pre> graph BT     B[Class B] --&gt; A[Class A]                     </pre>	<pre> public class A{     ..... } public class B extends A{     ..... }                     </pre>
<p>Multi Level inheritance</p> <pre> graph BT     C[Class C] --&gt; B[Class B]     B --&gt; A[Class A]                     </pre>	<pre> public class A { ..... } public class B extends A { ..... } public class C extends B { ..... }                     </pre>
<p>Hierarchical inheritance</p> <pre> graph TD     A[Class A] --&gt; B[Class B]     A --&gt; C[Class C]                     </pre>	<pre> public class A { ..... } public class B extends A { ..... } public class C extends B { ..... }                     </pre>
<p>Multiple inheritance</p> <pre> graph TD     A[Class A] --&gt; C[Class C]     B[Class B] --&gt; C                     </pre>	<pre> public class A { ..... } public class B { ..... } public class C extends A,B { ..... }                     </pre> <p><small>// Java does not support multiple inheritance</small></p>
<p><b>Example</b></p> <pre> public class Person, Teacher{                     </pre>	

LINK:

<https://youtu.be/XEMyFUuV31o?si=mG90GxD4gueDt7f0>



kalimnagar

PRINCIPAL,  
THE NDD BANADUR CALAYALA  
HETTY'S HINDU COLLEGE,  
MADHURAI NAGAR,  
AM, SELWAI - 600 072.

**DHARMAMURTHIRAOBHADHURCALAVALACUNNANCHETTY'SHIN  
DU COLLEGE PATTABIRAM CHENNAI – 72.**

**DEPARTMENT OF COMPUTER APPLICATION**

**II-BCA-'B'**

**ICT TOOLS STUDENTS- DATA STRUCTURES**

**STUDENT GROUP STUDY AND TEST**

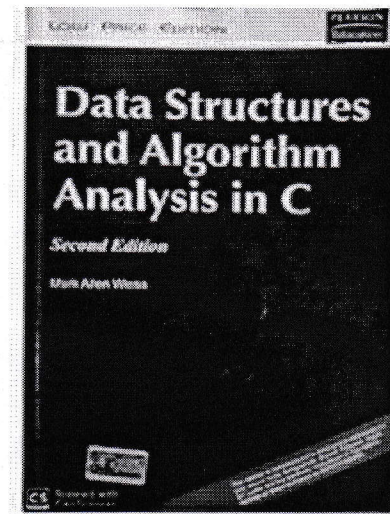
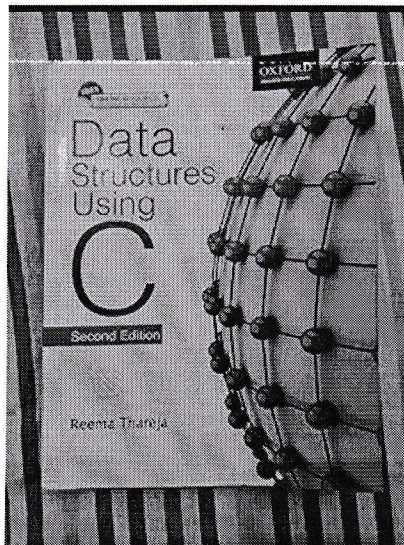
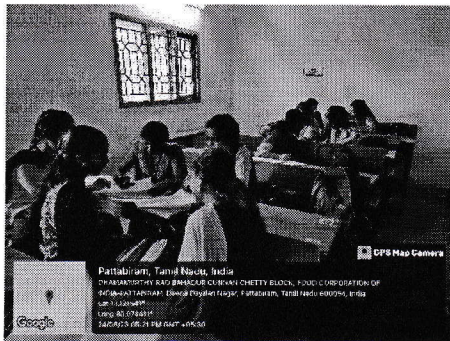

**TEXT BOOKS:**

1. Mark Allen Weiss, "Data Structures and Algorithm Analysis in C++", Pearson Education 2014, 4th Edition.
2. Reema Thareja, "Data Structures Using C", Oxford Universities Press 2014, 2nd Edition.

**REFERENCES:**

1. Thomas H. Cormen, Charles E. Leiserson, Ronald L. Rivest, Clifford Stein, "Introduction to Algorithms", McGraw Hill 2009, 3rd Edition.
2. Aho, Hopcroft and Ullman, "Data Structures and Algorithms", Pearson Education 2003..

## GOOGLE CLASSROOM:

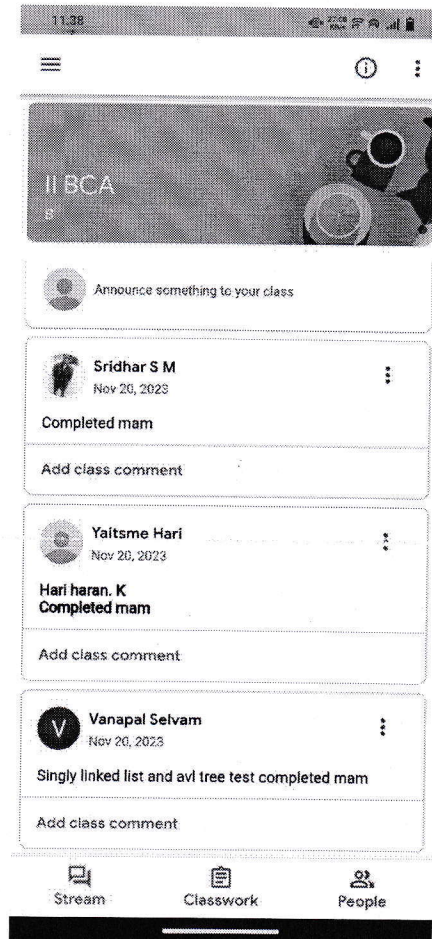
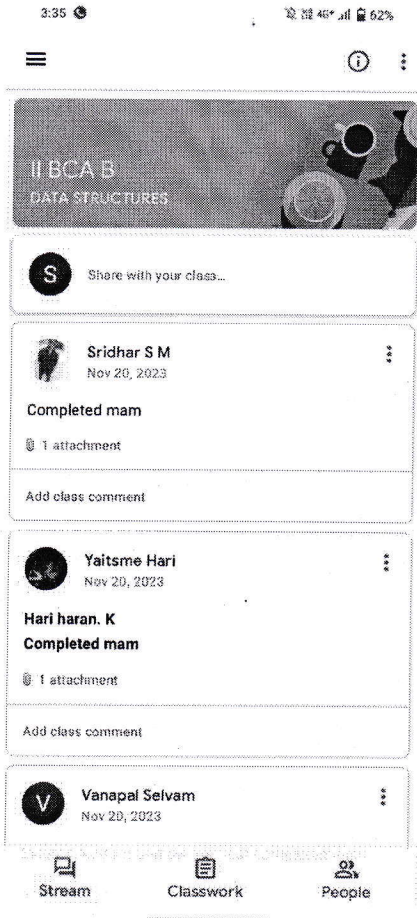

## YOUTUBEVIDEO:

LINK:

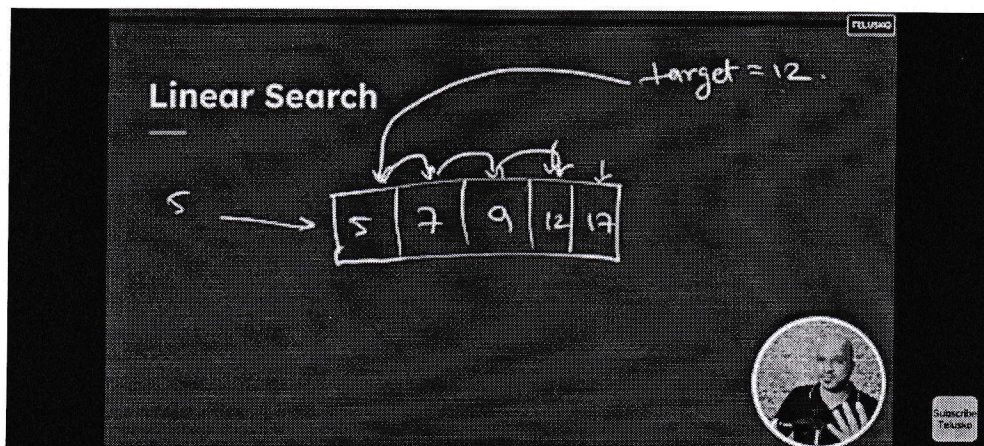

<https://youtu.be/xWLxhF3b5P8?si=CipbXrJRLqpgjie7>



G. Calinuray  
PRINCIPAL,  
DHARMAMURTHI RAO RAHADUR CALAVALA  
CUNNAN CHETTY'S HINDI COLLEGE,  
DHARMAMURTHI NAGAR,  
MADHURAI - 607202.

**DHARMAMURTHI RAO BAHADUR CALAVALACUNNAN  
CHETTY'SHINDUCOLLEGE PATTABIRAMCHENNAI-72**

**DEPARTMENT OF COMPUTER APPLICATION II**

**BCA B**

**ICT TOOLS STUDENTS**

**STUDENT GROUP STUDY AND TEST :**

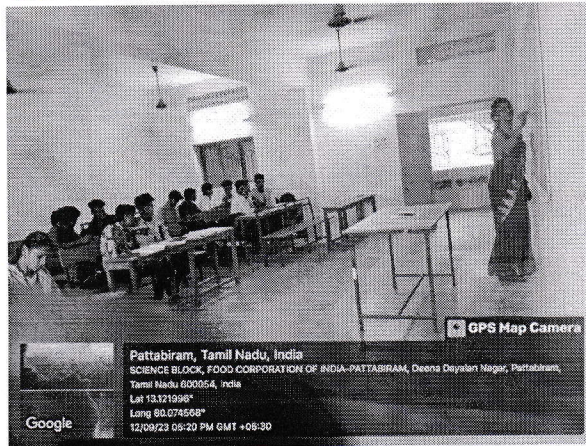

**REFERENCE BOOKS: PROGRAMMING WITH COMPUTER ORGANIZATION**

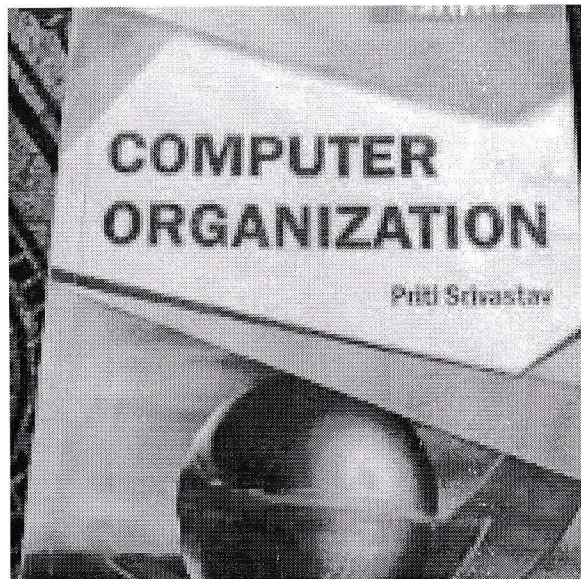

# GOOGLE CLASS : (ASSIGNMENT SUBMISSION)

**Pipeline Processing:**

pipelining.png

8257\_architecture.jpg

Add class comment

**JANSI PAUL**  
26 Oct 2023

Students, post your assignments on or before 28/10/23

1. Pipeline Diagram,
2. DMA Controller diagram (only diagram).
3. Instruction set- Answer in details

1 class comment

Stream Classwork People

Pin-Diagram-of-8257-1.jpg

Add class comment

**Monika Thirunavukarasu**  
28 Oct 2023

**Pipeline**

pipelining-1.png

Add class comment

**Gopika Suresh**  
28 Oct 2023

Stream Classwork People

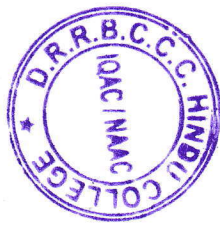

II BCA B COMPUTER ORGA...

Announce something to your class

**Niranjan**  
16 Nov 2023

Niranjan A  
22CA217

CO Assignment.pdf

Add class comment

**Nisha**  
6 Nov 2023

Assignment

co assignment .pdf

Add class comment

Stream Classwork People

**Shahitya Ravansiah**  
28 Oct 2023

Assignment

20211216100532\_61bdb2...

IMO\_20231026\_210853.jpg

+ 1 attachment

Add class comment

**Ancy B**  
28 Oct

Stream Classwork People

*G. Velumalai*  
PRINCIPAL,  
DHARMAMURTHI RAO BAHADUR CALAYALA  
CUNNAM CHETTY'S HINDU COLLEGE,  
DHARMAMURTHI NAGAR,  
PATTABIRAM, CHENNAI - 600 072.

**DHARMAMURTHI RAO BHADHUR CALAVALA CUNNAN CHETTY'S  
HINDU COLLEGE PATTABIRAM CHENNAI – 72.**

**DEPARTMENT OF COMPUTER APPLICATION  
II-BCA-'B'**

**ICT TOOLS STUDENTS – COMPUTER ORGANISATION**

**STUDENT GROUP STUDY AND TEST**

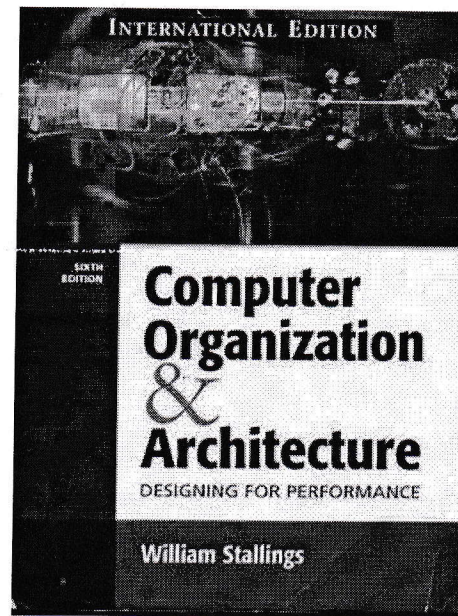
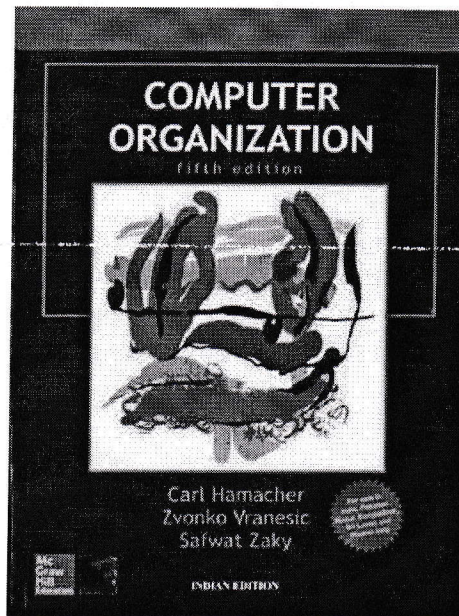
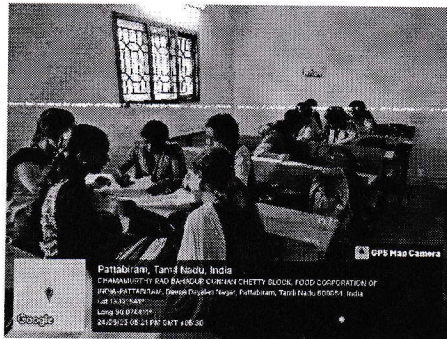

**REFERENCE BOOKS:**

1. Mathur- "Introduction to Microprocessor"- 3rd Edition- Tata McGraw-Hill-1993.
2. P. K. Ghosh and P. R. Sridhar- "0000 to 8085: Introduction to Microprocessors for Engineers and Scientists"- 2nd Edition- PHI- 1995.
3. NagoorKani- "Microprocessor (8085) and its Applications"- 2nd Edition- RBA Publications- 2006.
4. V. Vijayendran- "Fundamentals of Microprocessors – 8085"- S. Viswanathan Pvt. Ltd.- 2008.



*C. Calavala*  
PRINCIPAL,  
DHARMAMURTHI RAO BHADHUR CALAVALA  
CUNNAN CHETTY'S HINDU COLLEGE,  
DHARMAMURTHI BHAGAR

## GOOGLE CLASSROOM:

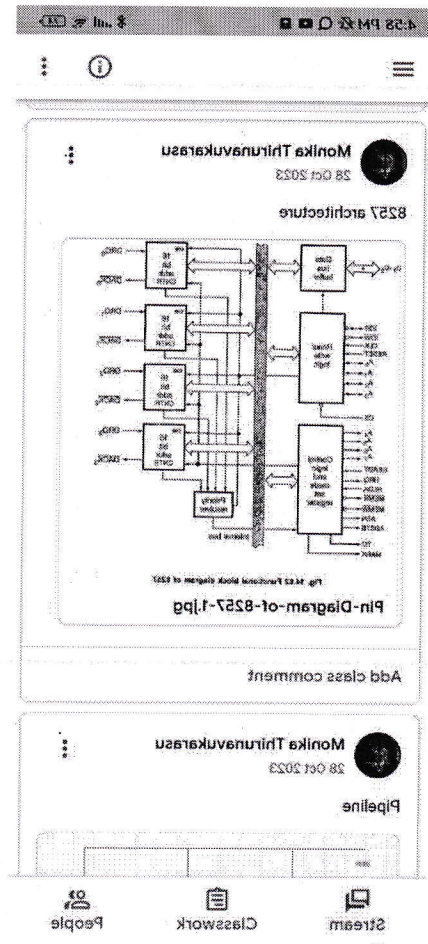
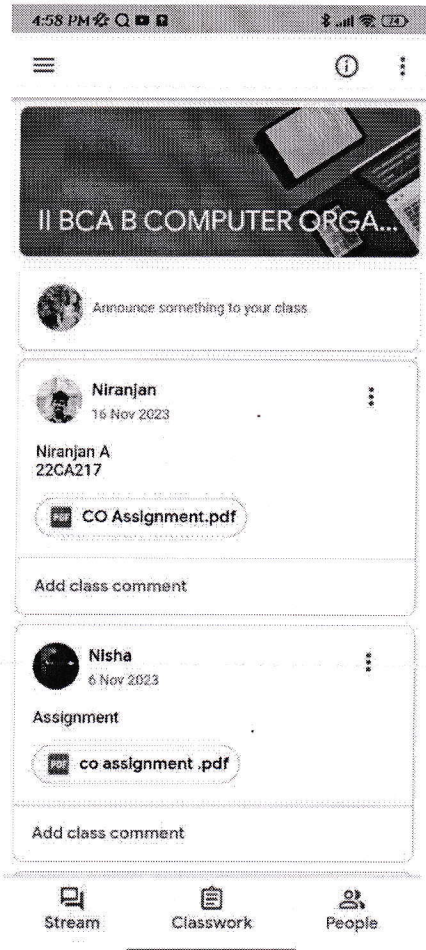

## YOUTUBE VIDEO:

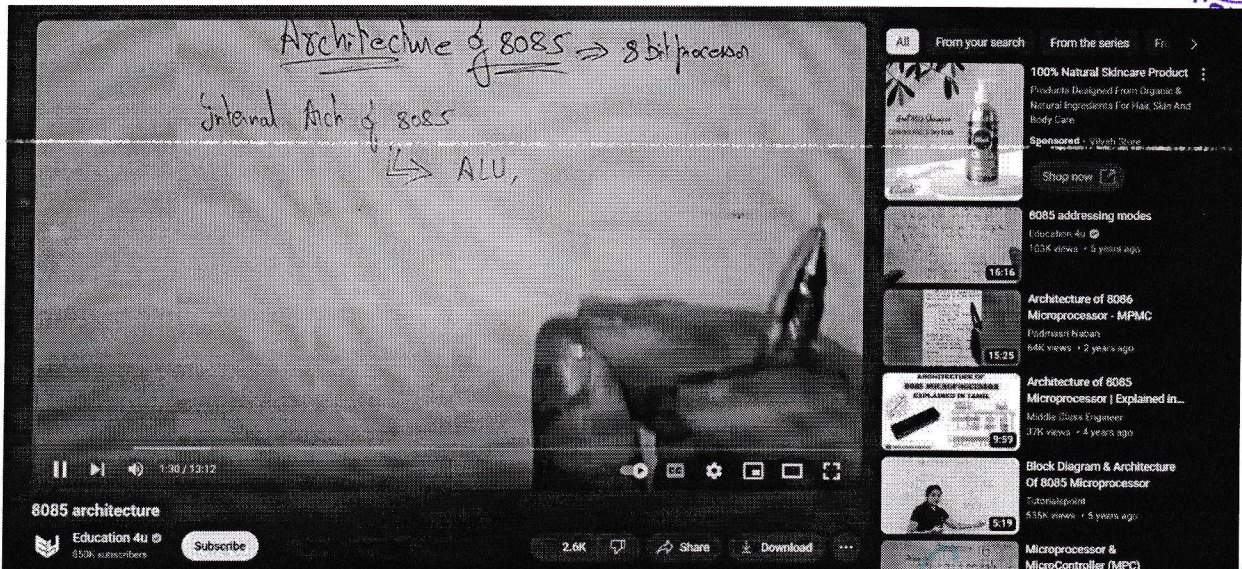

LINK:

<https://youtu.be/XEMyFUuV31o?si=mG90GxD4gueDt7fo>

C. C. HINDU COLLEGE  
D.R. C. HINDU COLLEGE  
IOAC / NAAC  
PRINCIPAL,  
BHARMAMURTHI RAO BAHADUR CALAWA  
CUMMANCHI, D.R. C. HINDU COLLEGE

**DHARMAMURTHI RAO BAHADUR CALAVALA CUNNAN CHETTY'S HINDU  
COLLEGE**

**PATTABIRAM, CHENNAI-600 072**

**DEPARTMENT OF COMPUTER APPLICATIONS**



**ICT TOOLS**

**2023-2024**

**ODD SEMESTER**



*G. Kalimuthu*  
PRINCIPAL,  
DHARMAMURTHI RAO BAHADUR CALAVALA  
CUNNAN CHETTY'S HINDU COLLEGE,  
DHARMAMURTHI NAGAR,  
PATTABIRAM, CHENNAI - 600 072.

**DHARMAMURTHI RAO BHADHUR CALAVALA CUNNAN CHETTY'S  
HINDU COLLEGE PATTABIRAM CHENNAI – 72.**

**DEPARTMENT OF COMPUTER APPLICATION  
III-BCA-'B'**

**ICT TOOLS STUDENTS - OPERATING SYSTEM**

**STUDENT GROUP STUDY AND TEST**

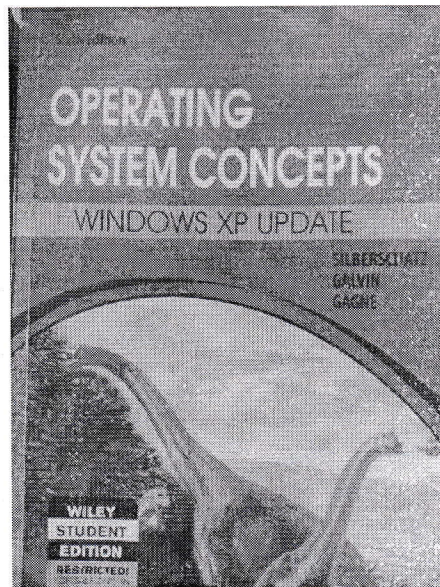

**REFERENCES:**

1. William Stallings, "Operating Systems Internals and Design Principles", Pearson, 2018, 9th Edition.
2. Andrew S. Tanenbaum, Herbert Bos, "Modern Operating Systems", Pearson 2014, 4th Edition.

## GOOGLE CLASSROOM:

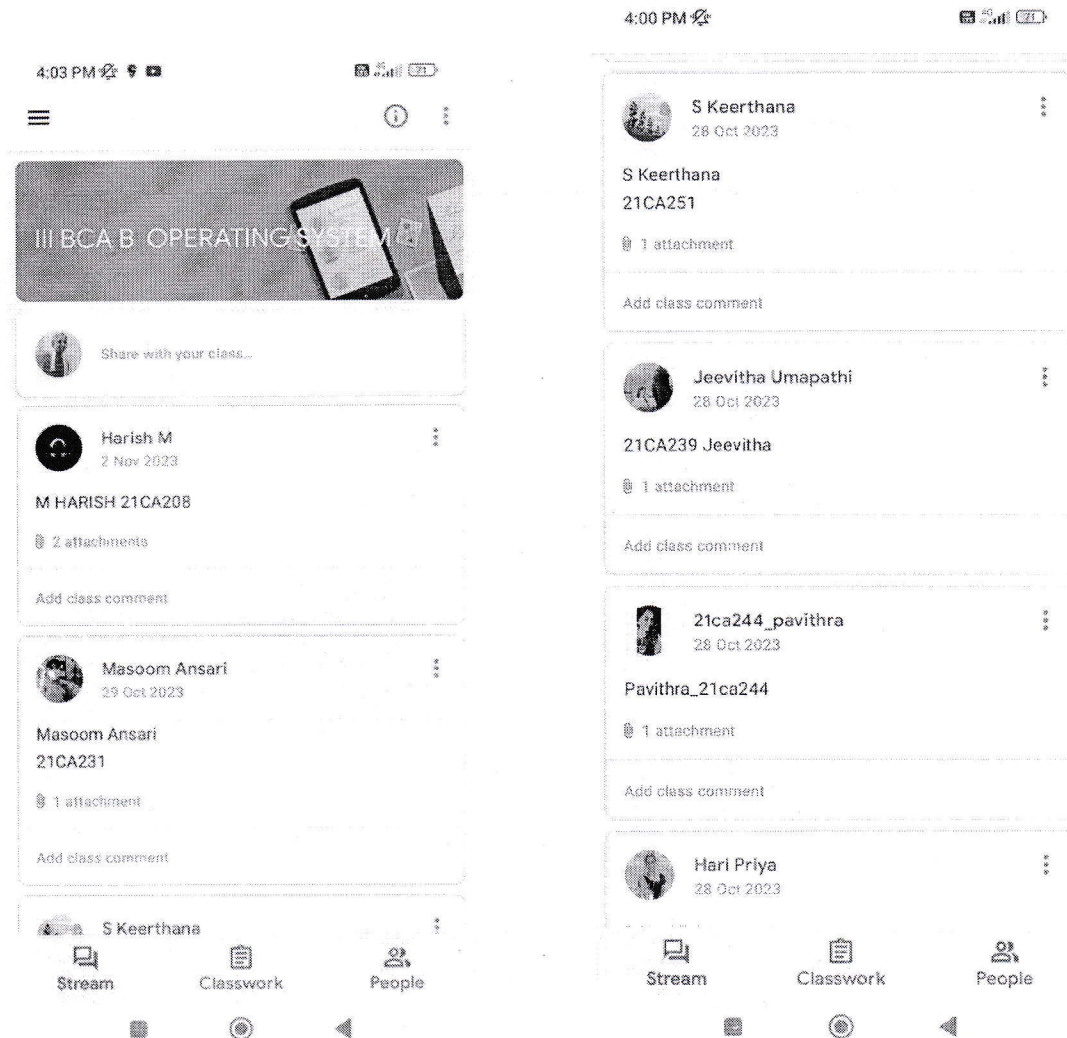

## YOUTUBE VIDEO:

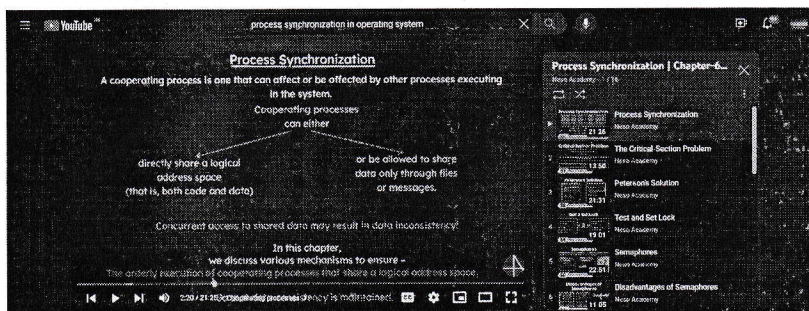

LINK:

<https://youtu.be/ph2awKa8r5Y?si=zPPjwnXA2XlAy6Nn>



*G. Kalpana Devi*  
PRINCIPAL,  
DHARMAMURTHI RAO BHADUR CALAVALA  
CUNNAN CHETTY HINDU COLLEGE,  
DHARMAMURTHI NAGAR,  
PATTABIRAM, CHENNAI - 600 072.

**DHARMAMURTHI RAO BHADHUR CALAVALA CUNNAN CHETTY'S  
HINDU COLLEGE PATTABIRAM CHENNAI – 72.**

**DEPARTMENT OF COMPUTER APPLICATION  
III-BCA-‘B’**

**ICT TOOLS STUDENTS - SOFTWARE ENGINEERING**

**STUDENT GROUP STUDY AND TEST**

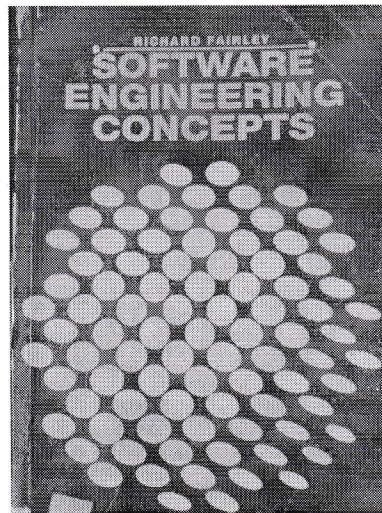
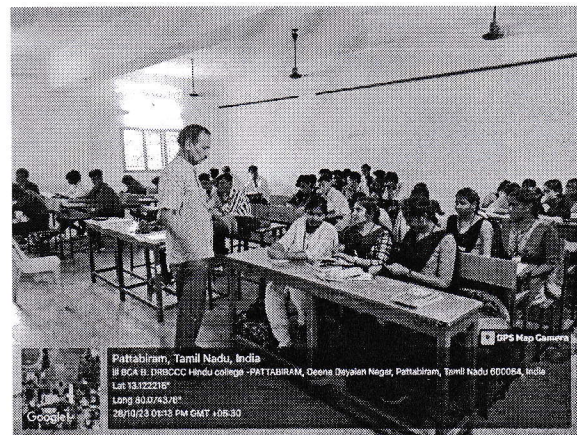

**REFERENCE BOOKS:**

1. Roger S. Pressman, “Software Engineering - A Practitioner’ s Approach” , McGraw Hill 2010, 7th Edition.
2. Pankaj Jalote, “An Integrated Approach to Software Engineering” , Narosa Publishing House 2011, 3rd Edition.

**WEB REFERENCES:**

- NPTEL & MOOC courses titled Software Engineering
- <https://nptel.ac.in/courses/106105182/>

**YOUTUBE VIDEO:**

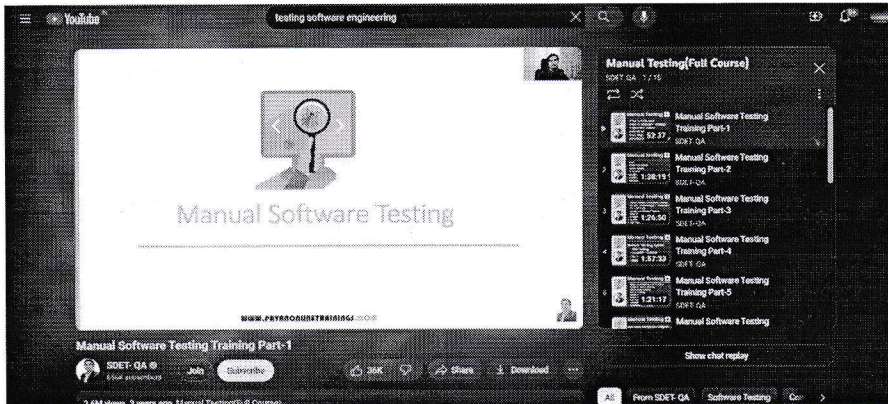

**LINK:**

<https://youtu.be/oOvURgHcd4w?si=Nf-ykCBCmW2JVRYC>



*G. Gopinathan*  
PRINCIPAL,  
DHARMAMURTHI RAO RAHADUR CALAVALA  
CUNNAN CHETTI'S HINDU COLLEGE,  
DHARMAMURTHI NAGAR,  
PATTABIRAM, CHENNAI - 600 072.

**DHARMAMURTHI RAO BHADHUR CALAVALA CUNNAN CHETTY'S  
HINDU COLLEGE PATTABIRAM CHENNAI – 72.**

**DEPARTMENT OF COMPUTER APPLICATION  
III-BCA-‘B’**

**ICT TOOLS STUDENTS - RDBMS**

**STUDENT GROUP STUDY AND TEST**

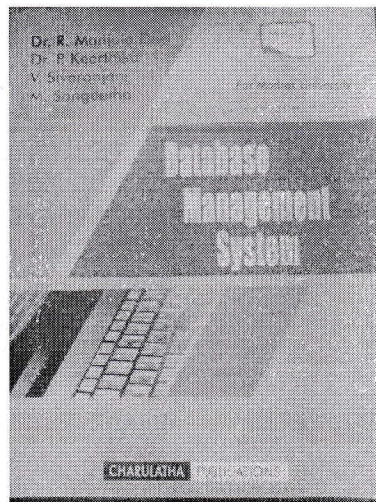
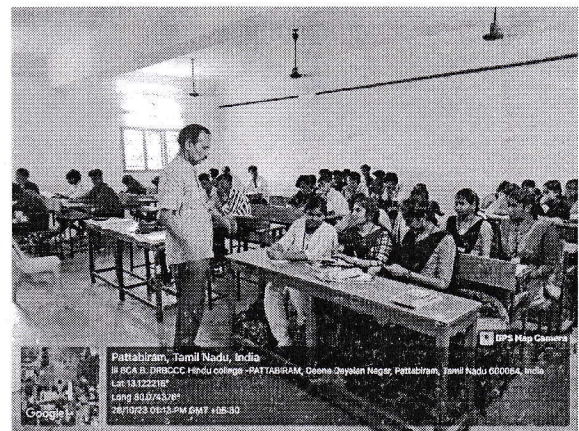
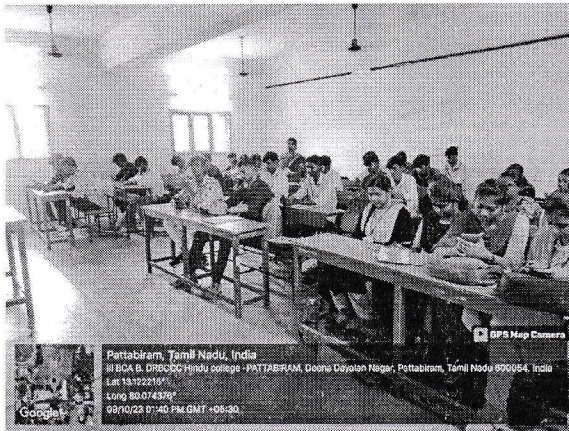

**REFERENCE BOOKS:**

1. Abraham Silberchatz, Henry F. Korth, S. Sudarshan, “Database System Concepts” , McGrawHill 2019, 7th Edition.
2. Alexis Leon & Mathews Leon, “Fundamentals of DBMS” , Vijay Nicole Publications 2014, 2nd Edition.

## GOOGLE CLASSROOM:

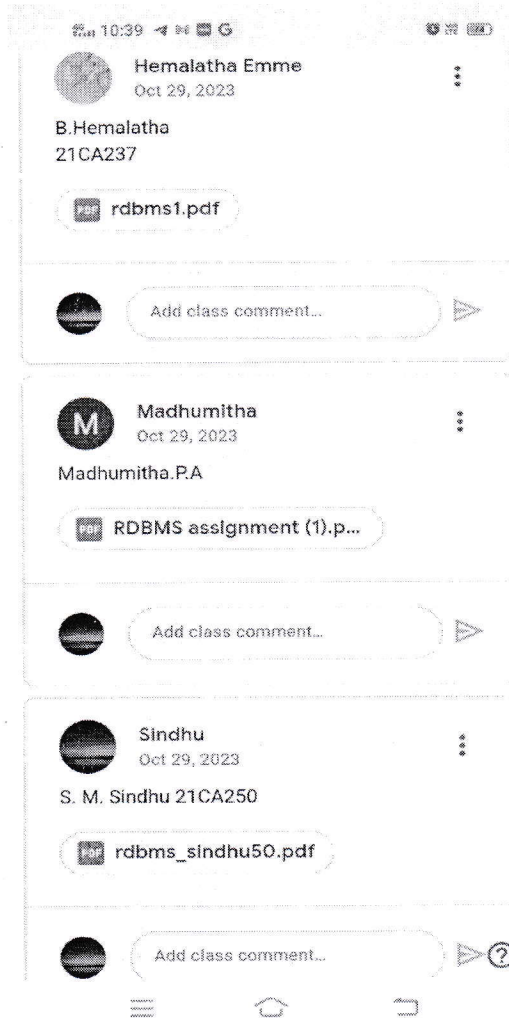
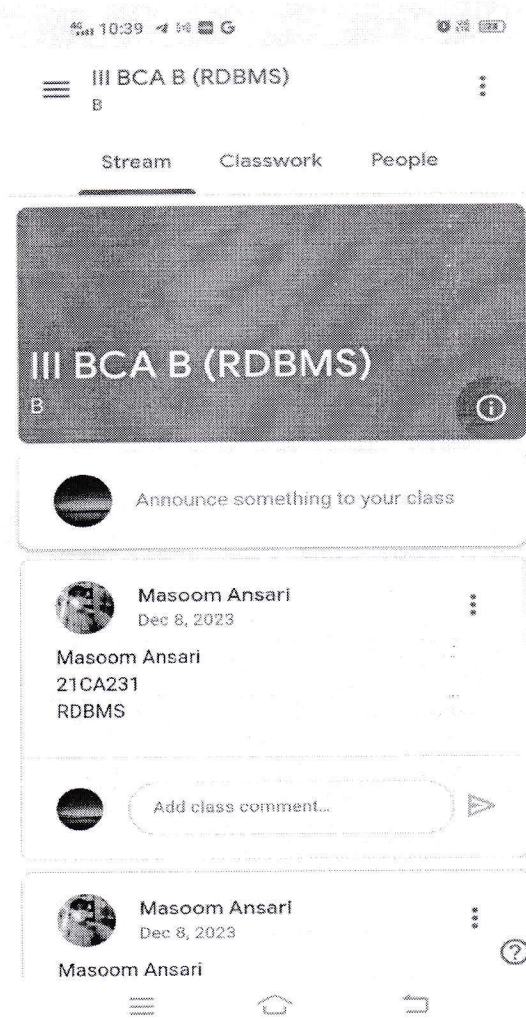

## YOUTUBE VIDEO:



## LINK:

<https://youtu.be/xoTyrdT9SZI?si=ExPYRZcGUuXaSCLA>



*G. Kalin...*  
PRINCIPAL,  
DHARMAMURTHI RAO BAHADUR CALAVALA  
CUNNAN CHITRA HINDU COLLEGE,  
SHANMUGANAGAR

**DHARMAMURTHI RAO BHADHUR CALAVALA CUNNAN CHETTY'S  
HINDU COLLEGE PATTABIRAM CHENNAI – 72.**

**DEPARTMENT OF COMPUTER APPLICATION  
III-BCA-'B'**

**ICT TOOLS STUDENTS - MULTIMEDIA**

**STUDENT GROUP STUDY AND TEST**

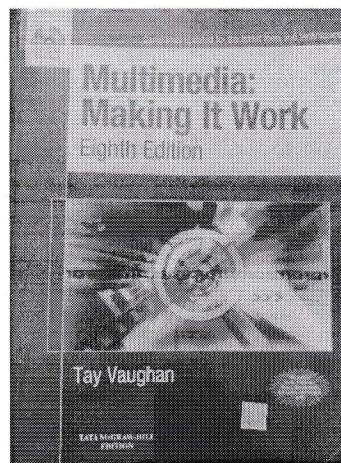
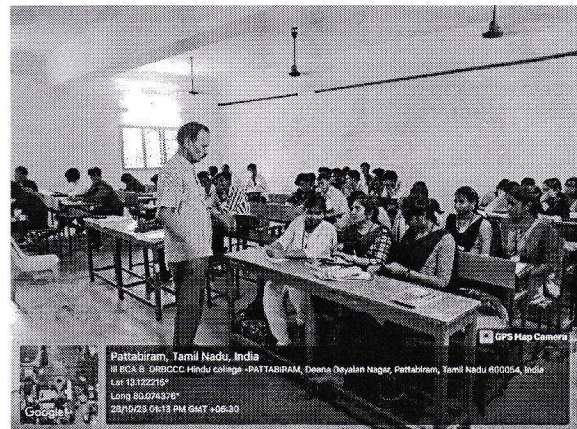

**REFERENCE BOOKS:** 1. Kiran Thakrar, Prabhat k.andleigh, "Multimedia System Design", Prentice Hall India, 1st Edition.

2. Malay k Pakhira, "Computer graphics, Multimedia and Animation", Prentice Hall India, 2nd Edition.

**WEB REFERENCES:**

- NPTEL & MOOC courses titled Multi media
- <https://nptel.ac.in/courses/106105163/>
- [W3schools.com/html/html-media.asp](http://W3schools.com/html/html-media.asp)

## GOOGLE CLASSROOM:

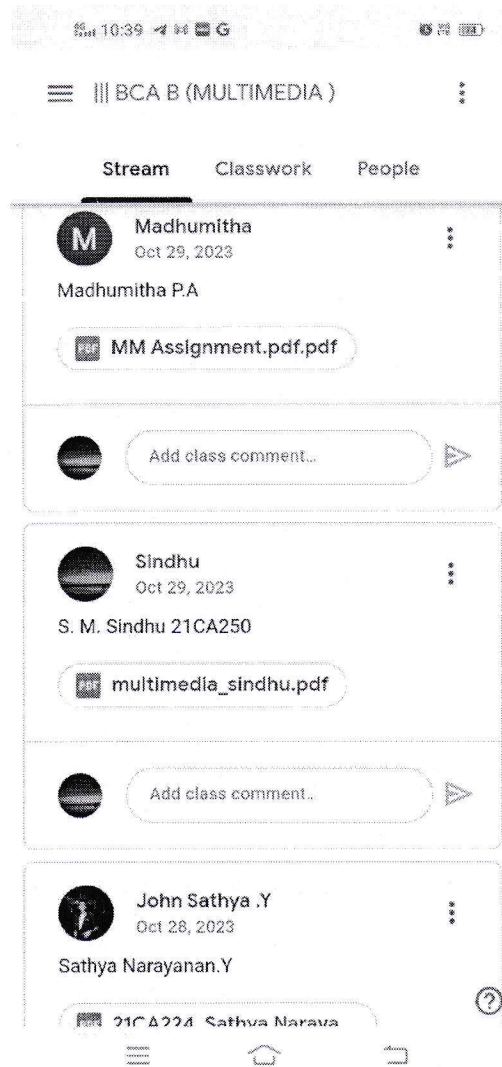
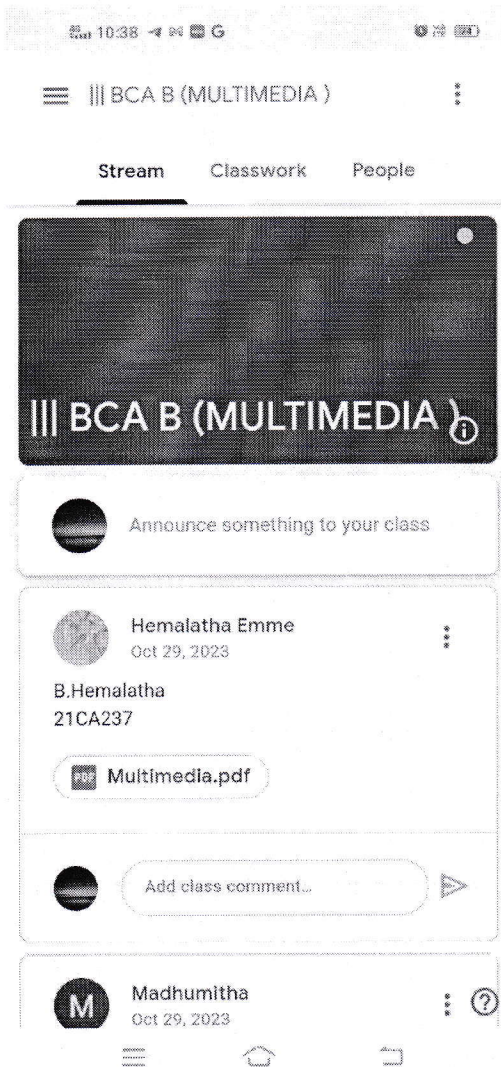

## YOUTUBE VIDEO:

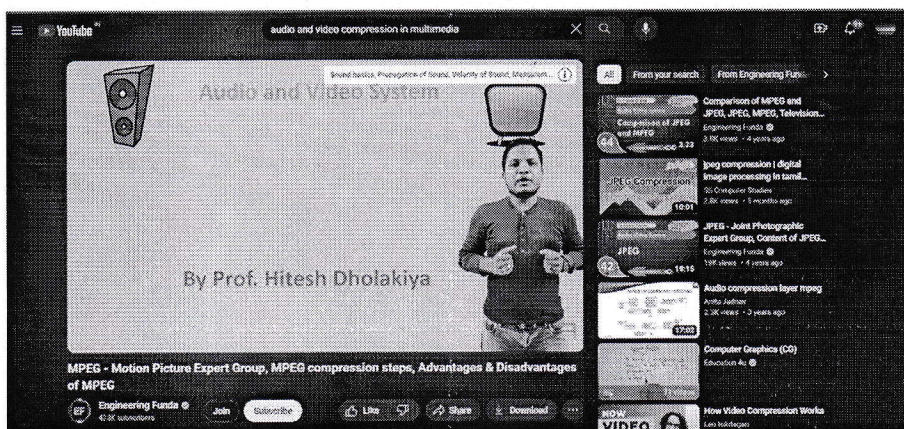

LINK:

<https://youtu.be/lAkuix41XJ8?si=yuHE7SDkaVa9KOjn>



*G. Vasu Naray*  
PRINCIPAL,  
DHARMAMURTHI RAO SAHADUR CALAVALA  
CONNAN CHETTY'S HINDU COLLEGE,  
DHARMAMURTHI NAGAR,  
PATTAMURAM CHENNAI 600 070

**DHARMAMURTHI RAO BAHADUR CALAVALA CUNNAM CHETTY'S HINDU  
COLLEGE**

**PATTABIRAM, CHENNAI-600 072**

**DEPARTMENT OF COMPUTER APPLICATIONS**



**PEER TEACHING**

**ODD SEMESTER**



*G. Kalinmayi*  
PRINCIPAL,  
DHARMAMURTHI RAO BAHADUR CALAVALA  
CUNNAM CHETTY'S HINDU COLLEGE,  
DHARMAMURTHI NAGAR,  
PATTABIRAM, CHENNAI - 600 072.

**DHARMAMURTHI RAO BHADHUR CALAVALLA CUNNAN  
CHETTY'S HINDU COLLEGE PATTABIRAM CHENNAI - 72.  
DEPARTMENT OF COMPUTER APPLICATIONS  
PEER TEACHING DATA STRUCTURE  
II-BCA-A**

S.NO	REGNO	NAME	DETAILS	DATE
1	22CA133	DEEPIKA SRI	PEER TO PEER TEACHING	28.10.23
2	22CA101	AAKASH D	PEER TO PEER TEACHING	29.10.23
3	22CA112	LOKESH KUMAR P	PEER TO PEER TEACHING	01.11.23
4	22CA2127	SURENDAR BABU	PEER TO PEER TEACHING	04.11.23
5	22CA144	PRIYANKA S	PEER TO PEER TEACHING	06.11.23
6	22CA135	HEMMALINI	PEER TO PEER TEACHING	07.11.23

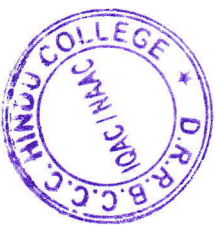

**PRINCIPAL,  
DHARMAMURTHI RAO BHADHUR CALAVALLA  
CUNNAN CHETTY'S HINDU COLLEGE,  
DHARMAMURTHI NAGAR,  
PATTABIRAM, CHENNAI - 600 072.**

*C. Vasiraman*

**DHARMAMURTHI RAO BHADHUR CALAVALA CUNNAN  
CHETTY'S HINDU COLLEGE PATTABIRAM CHENNAI - 72.  
DEPARTMENT OF COMPUTER APPLICATIONS  
PEER TEACHING JAVA  
II-BCA-A**

S.NO	REGNO	NAME	DETAILS	DATE
1	22CA133	DEEPIKA SRI	PEER TO PEER TEACHING	28.10.23
2	22CA101	AAKASH D	PEER TO PEER TEACHING	29.10.23
3	22CA112	LOKESH KUMAR P	PEER TO PEER TEACHING	01.11.23
4	22CA2127	SURENDAR BABU	PEER TO PEER TEACHING	04.11.23
5	22CA144	PRIYANKA S	PEER TO PEER TEACHING	06.11.23
6	22CA135	HEMMALINI	PEER TO PEER TEACHING	07.11.23



*C. Subramanyam*

PRINCIPAL,  
DHARMAMURTHI RAO BHADHUR CALAVALA  
CHETTY'S HINDU COLLEGE,  
PATTABIRAM, CHENNAI - 600 072.

**DHARMAMURTHI RAO BHADHUR CALAVALA CUNNAN**  
**CHETTY'S HINDU COLLEGE PATTABIRAM CHENNAI - 72.**  
**DEPARTMENT OF COMPUTER APPLICATIONS**  
**PEER TEACHING ORGANIZATION**

**II-BCA-A**

S.NO	REGNO	NAME	DETAILS	DATE
1	22CA133	DEEPIKA SRI	PEER TO PEER TEACHING	28.10.23
2	22CA101	AAKASH D	PEER TO PEER TEACHING	29.10.23
3	22CA112	LOKESH KUMAR P	PEER TO PEER TEACHING	01.11.23
4	22CA2127	SURENDAR BABU	PEER TO PEER TEACHING	04.11.23
5	22CA144	PRIYANKA S	PEER TO PEER TEACHING	06.11.23
6	22CA135	HEMMALINI	PEER TO PEER TEACHING	07.11.23



**PRINCIPAL,**  
**DHARMAMURTHI RAO BHADHUR CALAVALA**  
**CUNNAN CHETTY'S HINDU COLLEGE,**  
**DHARMAMURTHI NAGAR,**  
**PATTABIRAM, CHENNAI - 600 072.**

*C. Valluvanaray*

# DHARMAMURTHI RAO BAHADUR CALAYALA CUNNAN CHETTY'S HINDU COLLEGE

PATTTABIRAM, CHENNAI-600 072

DEPARTMENT OF COMPUTER APPLICATIONS



PEER TEACHING

ODD SEMESTER

2023-2024

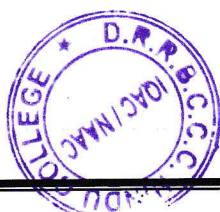

*G. Viswanaray*  
PRINCIPAL,  
DHARMAMURTHI RAO BAHADUR CALAYALA  
CUNNAN CHETTY'S HINDU COLLEGE,  
DHARMAMURTHI NAGAR,  
PATTABIRAM, CHENNAI - 600 072.

**DHARMAMURTHI RAO BAHADUR CALAVALA CUNNAN CHETTY'S HINDU COLLEGE**

**PATTABIRAM CHENNAI - 72**

**DEPARTMENT OF COMPUTER APPLICATIONS**

ADVANCE LEARNERS STUDENT LIST - 2022-2023

II BCA - "B" JAVA

S.NO	ROLLNO	REG NO	NAME	ACTIVITY	SIGNATURE
1	22CA203	212200216	ARUN KUMAR S	NATIONAL CONFERENCE	<i>S. Arun</i>
2	22CA204	212200218	ENOCH SMITH N	NATIONAL CONFERENCE	<i>N. Enoch</i>
3	22CA211	212200229	JAYA PRAKASH S	INTERNATIONAL, NATIONAL CONFERENCE	<i>S. Jayaprakash</i>
4	22CA222	212200258	SHARATH P	INTERNATIONAL, NATIONAL CONFERENCE	<i>P. Sri</i>
5	22CA226	212200264	VIGNESH D	INTERNATIONAL CONFERENCE	<i>Vignesh D</i>
6	22CA213	212200235	LOKESHWARAN N	SEMINAR / PEER TEACHING	<i>lokesh . A.</i>
7	22CA215	212200240	NAGARAJ M	SEMINAR / PEER TEACHING	<i>M. Nagaraj</i>
8	22CA220	212200248	RITHIK B	SEMINAR / PEER TEACHING	<i>R. Ritik</i>
9	22CA225	212200263	VANAPAL SELVAM M	SEMINAR / PEER TEACHING	<i>M. Vanapal Selvam</i>

**FEMALE**

10	22CA230	212200270	ANITHA I	INTERNATIONAL, NATIONAL CONFERENCE	<i>I. Anitha</i>
11	22CA232	212200276	DHANUSHREE R	CONFERENCE	<i>R. Dhanshree</i>
12	22CA233	212200277	GOPIKA S	CONFERENCE	<i>S. Gopika</i>
13	22CA234	212200279	HEMASREE D	INTERNATIONAL, NATIONAL CONFERENCE	<i>D. Hemasree</i>
14	22CA238	212200289	MONIKA T	INTERNATIONAL CONFERENCE	<i>T. Monika</i>

15	22CA239	212200290	NARMATHADEVI G	SEMINAR / PEER TEACHING	G. Narasimachandrar
16	22CA240	212200291	NITHYASRI A	INTERNATIONAL, NATIONAL CONFERENCE	A. Nithyasri
17	22CA241	212200293	PAVITHRA C	SEMINAR / PEER TEACHING	C Pavithra
18	22CA244	212200301	SHRI ILAKKIYA L Y	INTERNATIONAL, NATIONAL CONFERENCE	S. Shri Lakshmi
19	22CA245	2122002302	SREE NIDHI U	SEMINAR / PEER TEACHING	U. Sree Nidhi
20	22CA246	212200303	SWETHA S	INTERNATIONAL CONFERENCE	S. Swetha
21	22CA247	212200306	USHANJALI P	NATIONAL CONFERENCE	P. Ushanya
22	22CA248	212200308	JIGYA KEERTANAA P	INTERNATIONAL, NATIONAL CONFERENCE	J. Jyoti Keertana

*P. Ushanya*  
SUBJECT INCHARGE

HEAD OF THE DEPARTMENT

**D.R.N. VENKATARAMANAN,**  
M.E., M.Sc(Maths), M.Phil, PGDCA, B.Ed, Ph.D  
Associate Professor & Head  
Dept of Computer Applications  
**DRBCCC HINDU COLLEGE**  
Pattabiram, Chennai-600 072, TN, India.



*C. Ushanya*  
PRINCIPAL,  
DHARMANURTHI MAO BHADUR CALAVILA  
GUNMAN CHITTAI HINDU COLLEGE,  
DHARMANURTHI PUSAR,  
PATTABIRAM, CHENNAI - 600 072.

# DEPARTMENT OF COMPUTER APPLICATIONS

## ADVANCE LEARNERS STUDENT LIST - 2022-2023

### DATA STRUCTURES

#### II BCA - "B"

S.NO	ROLLNO	REG NO	NAME	ACTIVITY	DATE
1	22CA203	212200216	ARUN KUMAR S	PEER TEACHING	5.10.23
2	22CA204	212200218	ENOCH SMITH N	PEER TEACHING	7.10.23
3	22CA211	212200229	JAYA PRAKASH S	PEER TEACHING	10.10.23
4	22CA222	212200258	SHARATH P	PEER TEACHING	13.10.23
5	22CA226	212200264	VIGNESH D	PEER TEACHING	17.10.23

#### FEMALE

6.	22CA230	212200270	ANITHA I	PEER TEACHING	25.10.23
7.	22CA233	212200277	GOPIKA S	PEER TEACHING	4.11.23
8.	22CA234	212200279	HEMASREE D	PEER TEACHING	7.11.23
9.	22CA238	212200289	MONIKA T	PEER TEACHING	10.11.23
10.	22CA240	212200291	NITHYASRI A	PERSPECTIVE TEACHING	16.11.23
11.	22CA244	212200301	SHRI LAKKIYA L Y	PEER TEACHING	18.11.23
12.	22CA247	212200306	USHANJALI P	PERSPECTIVE TEACHING	21.11.23
13.	22CA248	212200308	JIGYA KEERTANAA P	PEER TEACHING	22.11.23

SUBJECT INCHARGE



*C. Venkataramanan*  
PRINCIPAL  
DI: ARMA MURTHI DAS RAJADUR CAIAVALA  
CUNNINGHAM CHRISTIAN MISSIONS COLLEGE,  
DHARMSARAM, CHENNAI - 600 072.  
PATYASRAM, CHENNAI - 600 072.

**DR. N. VENKATARAMANAN,**  
ME, M.Sc(Maths), M.Phil, PGDCA, B.Ed, Ph.D  
Associate Professor & Head  
Dept. of Computer Applications  
**HEAD OF THE DEPARTMENT**  
Patyasarum, Chennai-600 072, TN, India

# DEPARTMENT OF COMPUTER APPLICATIONS

ADVANCE LEARNERS STUDENT LIST - 2022-2023

## COMPUTER ORGANIZATION

II BCA - "B"

S.NO	ROLLNO	REG NO	NAME	ACTIVITY	DATE
1	22CA203	212200216	ARUN KUMAR S	PEER TEACHING	5.10.23
2	22CA204	212200218	ENOCH SMITH N	PEER TEACHING	7.10.23
3	22CA211	212200229	JAYA PRAKASH S	PEER TEACHING	10.10.23
4	22CA222	212200258	SHARATH P	PEER TEACHING	13.10.23
5	22CA226	212200264	VIGNESH D	PEER TEACHING	17.10.23

## FEMALE

6.	22CA230	212200270	ANITHA I	PEER TEACHING	25.10.23
7.	22CA233	212200277	GOPIKA S	PEER TEACHING	4.11.23
8.	22CA234	212200279	HEMASREE D	PEER TEACHING	7.11.23
9.	22CA238	212200289	MONIKA T	PEER TEACHING	10.11.23
10.	22CA240	212200291	NITHYASRI A	PERSPECTIVE TEACHING	16.11.23
11.	22CA244	212200301	SHRI ILAKKIYA L Y	PEER TEACHING	18.11.23
12.	22CA247	212200306	USHANJALI P	PERSPECTIVE TEACHING	21.11.23
13.	22CA248	212200308	JIGYA KEERTANAA P	PEER TEACHING	22.11.23

SUBJECT INCHARGE

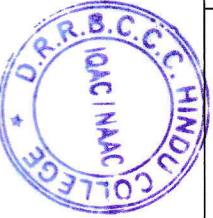

*G. Srinivasan*  
PRINCIPAL,  
DHARMAMURTHI RAO SARADUR CALAWALA  
(URBAN CHETIVS HINDU COLLEGE,  
DHARMAMURTHI RAO SARADUR,  
PATTABIRAM, CHENNAI - 600 072.

DR. N. VENKATARAMANAN,  
M.E., M.Sc., M.Phil., PGDCA, B.Ed., Ph.D.  
Professor & Head  
DEPT. OF THE DEPARTMENT  
DRACC HINDU COLLEGE,  
Pattabiram, Chennai-600 072, TN, India.

**DHARMAMURTHI RAO BAHADUR CALAYALA CUNNAN CHETTY'S HINDU  
COLLEGE**

**PATTABIRAM, CHENNAI-600 072**

**DEPARTMENT OF COMPUTER APPLICATIONS**



**PEER TO PEER TEACHING**

**2023-2024**

**ODD SEMESTER**



*G. Kalinayagi*  
PRINCIPAL,  
DHARMAMURTHI RAO BAHADUR CALAYALA  
CUNNAN CHETTY'S HINDU COLLEGE,  
DHARMAMURTHI RAO BAHADUR CALAYALA  
PATTABIRAM, CHENNAI - 600 072.

**DHARMAMURTHI RAO BHADHUR CALAVALA CUNNAN**  
**CHETTY'S HINDU COLLEGE PATTABIRAM CHENNAI - 72.**  
**DEPARTMENT OF COMPUTER APPLICATIONS**  
**PEER TEACHING OPERATING SYSTEM**  
**III-BCA-B**

S.NO	REGNO	NAME	DETAILS	DATE
1	212100280	BHAVADHARANI . M	PEER TO PEER TEACHING	28.10.23
2	212100283	DIVYABHARATHIR	PEER TO PEER TEACHING	29.10.23
3	212100285	HARIPRIYA.D	PEER TO PEER TEACHING	01.11.23
4	212100287	JABHASTENA .M	PEER TO PEER TEACHING	04.11.23
5	212100289	JEEVITHA . U	PEER TO PEER TEACHING	06.11.23
6	212100302	RAKSHITHA .K	PEER TO PEER TEACHING	07.11.23
7	212100303	RANJINI .S	PEER TO PEER TEACHING	09.11.23
8	212100215	MADHUMITHA .P.A	PEER TO PEER TEACHING	13.11.23
9	212100214	GOGLA SHALINI	PEER TO PEER TEACHING	15.11.23

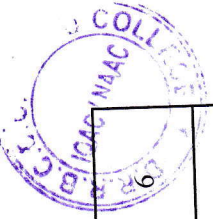

*C. Subramanyam*  
**PRINCIPAL,**  
**DHARMAMURTHI RAO BHADHUR CALAVALA**  
**CUNNAN CHETTY'S HINDU COLLEGE,**  
**DHARMAMURTHI PAGERI,**  
**PATTABIRAM, CHENNAI - 600 072.**

**DHARMAMURTHI RAO BHADHUR CALAVALA CUNNAN**  
**CHETTY'S HINDU COLLEGE PATTABIRAM CHENNAI - 72.**  
**DEPARTMENT OF COMPUTER APPLICATIONS**  
**PEER TEACHING SOFTWARE ENGINEERING**  
**III-BCA-B**

S.NO	REGNO	NAME	DETAILS	DATE
1	212100280	BHAVADHARANI . M	PEER TO PEER TEACHING	27.10.23
2	212100283	DIVYABHARATHI.R	PEER TO PEER TEACHING	01.11.23
3	212100285	HARIPRIYA.D	PEER TO PEER TEACHING	02.11.23
4	212100287	JABHASTENA .M	PEER TO PEER TEACHING	03.11.23
5	212100289	JEEVITHA . U	PEER TO PEER TEACHING	05.11.23
6	212100302	RAKSHITHA .K	PEER TO PEER TEACHING	07.11.23
7	212100303	RANJINI. S	PEER TO PEER TEACHING	08.11.23
8	212100215	MADHUMITHA .P.A	PEER TO PEER TEACHING	10.11.23
9	212100214	GOGLA SHALINI	PEER TO PEER TEACHING	12.11.23



**PRINCIPAL,**  
**DHARMAMURTHI RAO BHADHUR CALAVALA**  
**CUNNAN CHETTY'S HINDU COLLEGE,**  
**DHARMAMURTHI NAGAR,**  
**PATTABIRAM, CHENNAI - 600 072.**

**DHARMAMURTHI RAO BHADHUR CALAVALA CUNNAN**  
**CHETTY'S HINDU COLLEGE PATTABIRAM CHENNAI - 72.**  
**DEPARTMENT OF COMPUTER APPLICATIONS**  
**PEER TEACHING RDBMS**  
**III-BCA-B**

S.NO	REGNO	NAME	DETAILS	DATE
1	212100280	BHAVADHARANI . M	PEER TO PEER TEACHING	27.10.23
2	212100283	DIVYABHARATHI.R	PEER TO PEER TEACHING	01.11.23
3	212100285	HARIPRIYA.D	PEER TO PEER TEACHING	02.11.23
4	212100287	JABHASTENA .M	PEER TO PEER TEACHING	03.11.23
5	212100289	JEEVITHA . U	PEER TO PEER TEACHING	05.11.23
6	212100302	RAKSHITHA .K	PEER TO PEER TEACHING	07.11.23
7	212100303	RANJINI. S	PEER TO PEER TEACHING	08.11.23
8	212100215	MADHUMITHA .P.A	PEER TO PEER TEACHING	10.11.23
9	212100214	GOGLA SHALINI	PEER TO PEER TEACHING	12.11.23

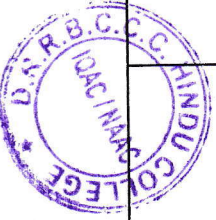

**DHARMAMURTHI RAO BHADHUR CALAVALA**  
**CUNNAN (CHETTY'S HINDU COLLEGE,**  
**DHARMAMURTHI NAGAR,**  
**PATTABIRAM, CHENNAI - 600 072.**

**DHARMAMURTHI RAO BHADHUR CALAVALA CUNNAN  
CHETTY'S HINDU COLLEGE PATTABIRAM CHENNAI - 72.  
DEPARTMENT OF COMPUTER APPLICATIONS  
PEER TEACHING MULTIMEDIA  
III-BCA-B**

S.NO	REGNO	NAME	DETAILS	DATE
1	212100280	BHAVVADHARANI . M	PEER TO PEER TEACHING	28.10.23
2	212100283	DIVYABHARATHI.R	PEER TO PEER TEACHING	29.10.23
3	212100285	HARIPRIYA.D	PEER TO PEER TEACHING	01.11.23
4	212100287	JABHASTENA .M	PEER TO PEER TEACHING	04.11.23
5	212100289	JEEVITHA . U	PEER TO PEER TEACHING	06.11.23
6	212100302	RAKSHITHA .K	PEER TO PEER TEACHING	07.11.23
7	212100303	RANJINI . S	PEER TO PEER TEACHING	09.11.23
8	212100215	MADHUMITHA .P.A	PEER TO PEER TEACHING	13.11.23
9	212100214	GOGLA SHALINI	PEER TO PEER TEACHING	15.11.23

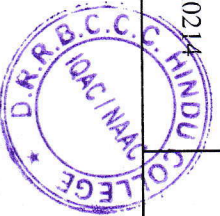

**PRINCIPAL,  
DHARMAMURTHI RAO BHADHUR CALAVALA  
CUNNAN CHETTY'S HINDU COLLEGE,  
PATTABIRAM, CHENNAI - 600 072.**